

SENSOR

Name	Symbol	Name	Symbol
A/C pressure sensor	E	Interior temperature sensor	d
Accelerator pedal position sensor	c	Left bank detonation sensor <6B31>	X
Air flow sensor	D	Left bank oxygen sensor (front) <6B31>	Z
Ambient temperature sensor	H	Left bank oxygen sensor (rear) <6B31>	h
Back sensor <Vehicles with reversing sensor system>	x	Lighting control sensor <Vehicles with rain sensitive AUTO wiper>	k
Battery current sensor <4B11, 4B12 (Except vehicles for Russia and FFV)>	W	Manifold absolute pressure sensor <4B1, 6B31>	S
Boost pressure sensor <BSY>	G	Output shaft speed sensor <A/T>	q
Camshaft position sensor <BSY, 4HN, 6B31>	A	Oxygen sensor <4HN-TC-SST>	K
Crank angle sensor	F	Oxygen sensor (front) <4B1>	s
Detonation sensor <4B1>	P	Oxygen sensor (rear) <4B1>	u
Electronic-controlled throttle valve (incorporating throttle position sensor) <4HN, 4B1, 6B31>	N	Photo sensor <Vehicles without rain sensitive AUTO wiper>	b
Engine coolant temperature sensor	C	Primary pulley speed sensor <CVT>	V
Engine oil level sensor <4HN>	M	Rail pressure sensor <4HN>	A
Exhaust camshaft position sensor <4B1>	Q	Rear corner sensor <Vehicles with reversing sensor system>	x
Exhaust differential pressure sensor <4HN>	J	Rear height sensor <Vehicles with headlamp automatic levelling system>	o
Exhaust gas temperature sensor <4HN>	t	Rear wheel speed sensor	w
Fin thermo sensor	g	Right bank detonation sensor <6B31>	X
Front height sensor <Vehicles with headlamp automatic levelling system>	i	Right bank oxygen sensor (front) <6B31>	j
Front impact sensor	l	Right bank oxygen sensor (rear) <6B31>	j
Front wheel speed sensor	r	Secondary pulley speed sensor <CVT>	R
Fuel filter water sensor <4HN>	O	Shift lever (incorporating lever position sensor) <TC-SST>	e

Fuel temperature sensor <BSY, 4HN>	B	Side impact sensor (front)	v
G and yaw rate sensor <Vehicles with ASC>	f	Side impact sensor (rear)	p
Input shaft position sensor <A/T>	Y	Steering wheel sensor <Vehicles with ASC>	a
Intake air pressure sensor <4HN>	N	Unlock sensor <Vehicles with KOS>	n
Intake air temperature sensor <4HN>	L	Vehicle speed sensor <4B1-M/T>	U
Intake camshaft position sensor <4B1>	T		

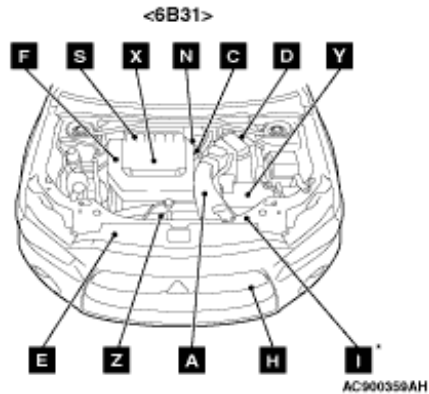

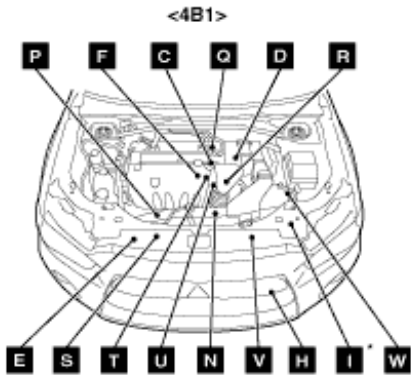
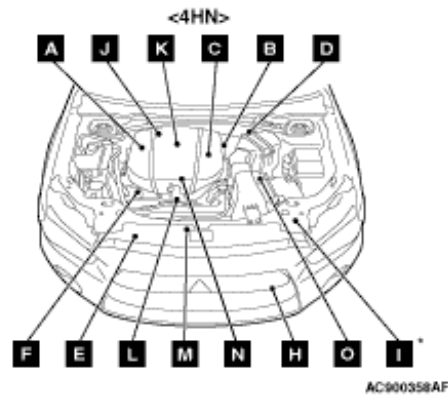
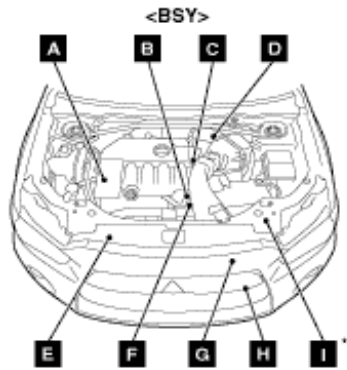
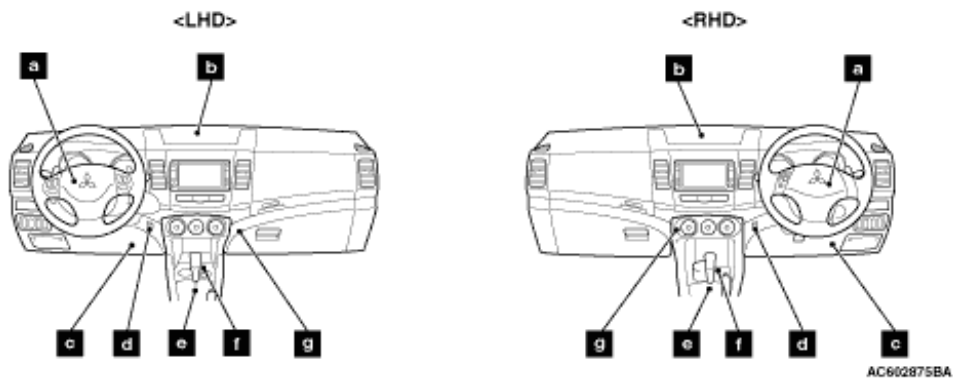

AC602875BA

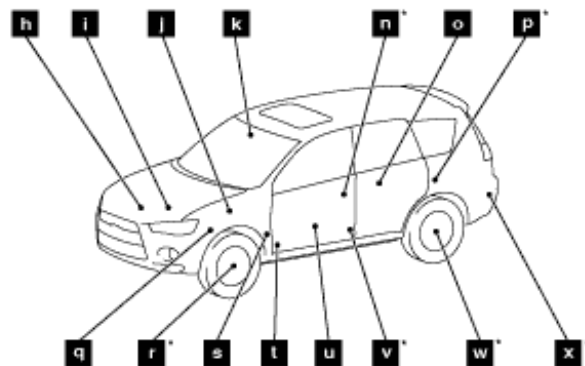

AC900356AE

note *:also equipped at the right side.



AC504174AE

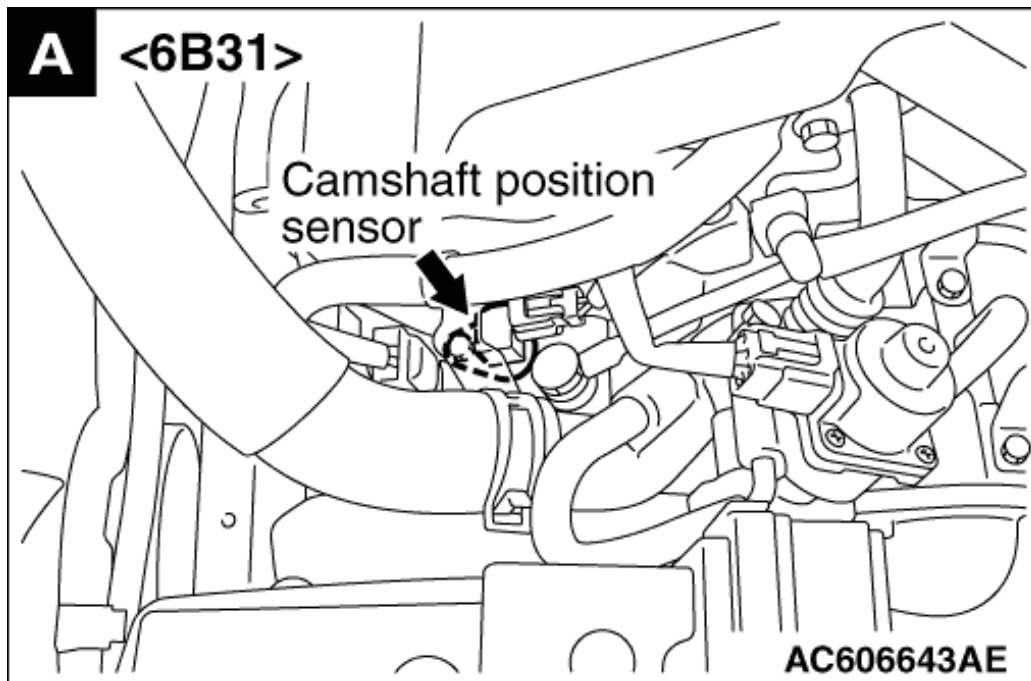
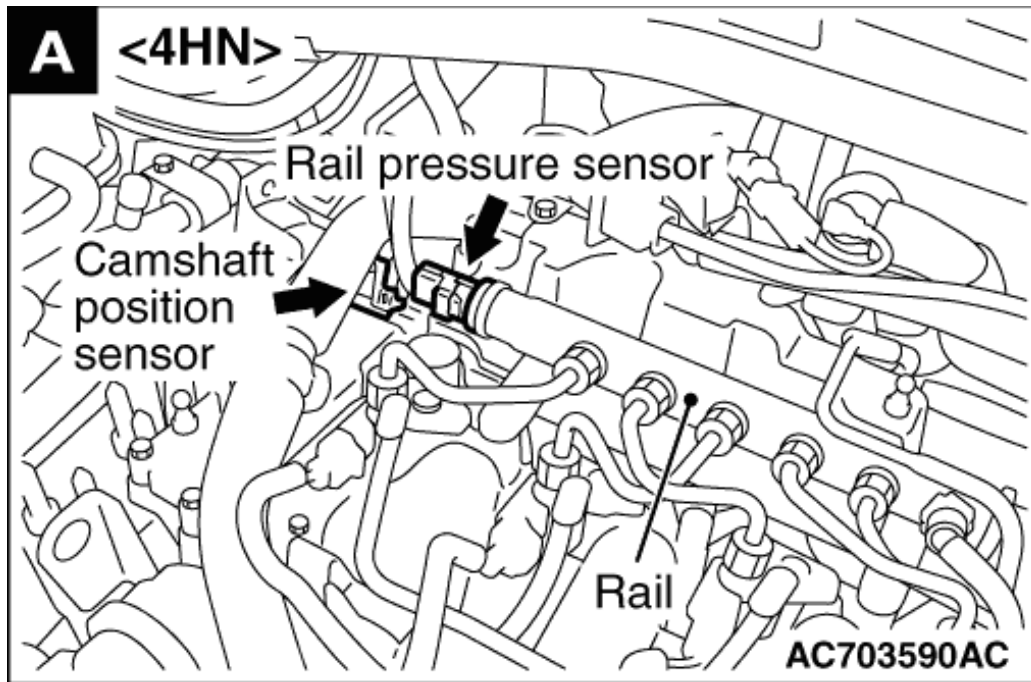

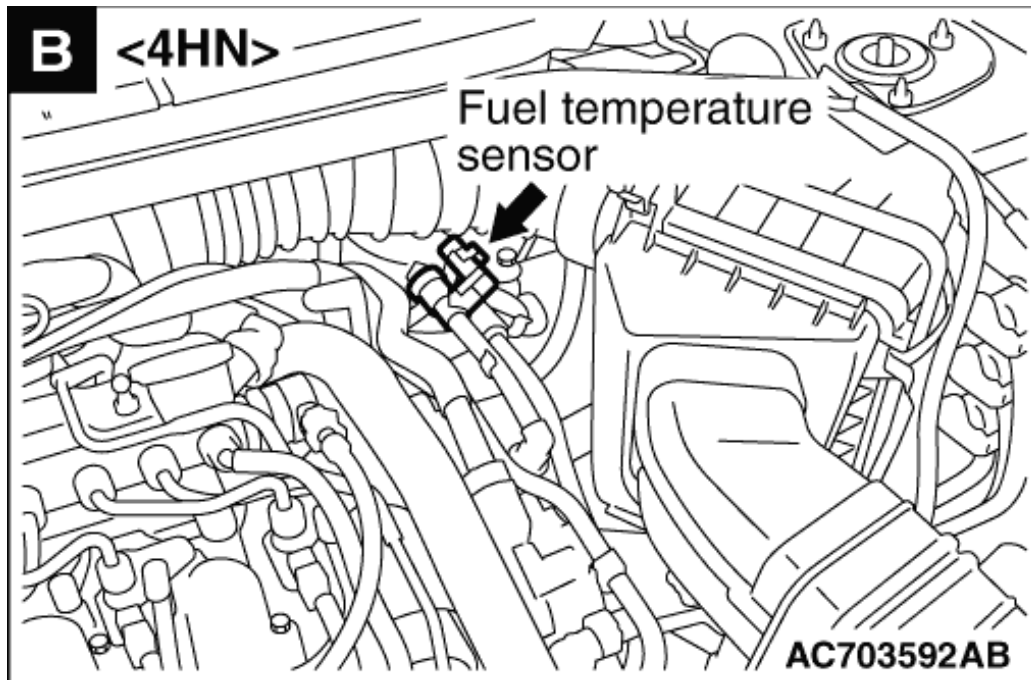
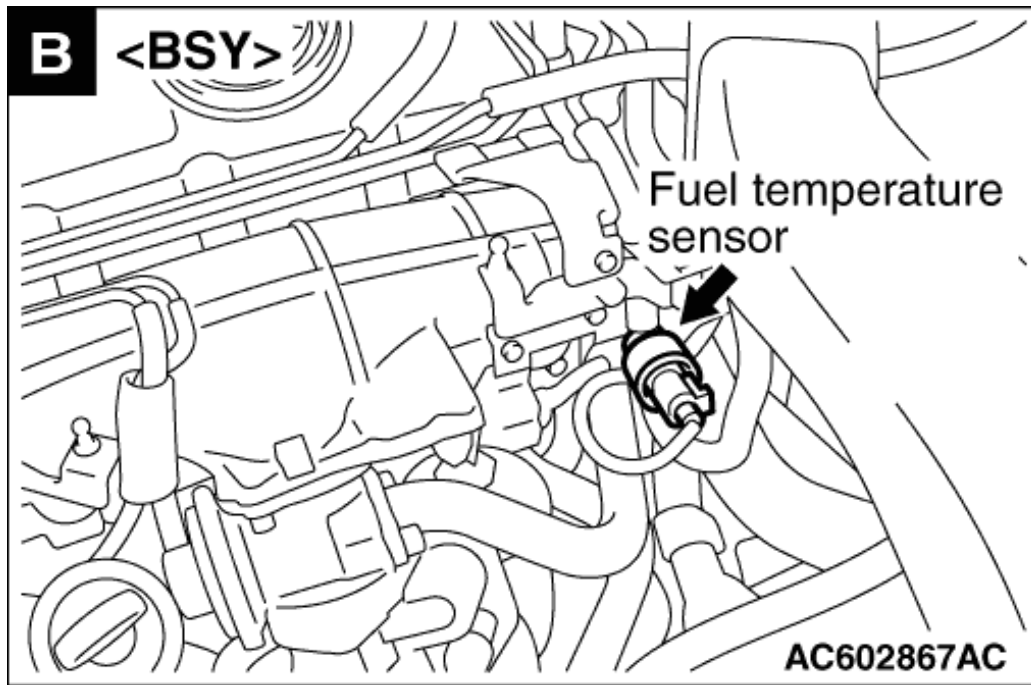

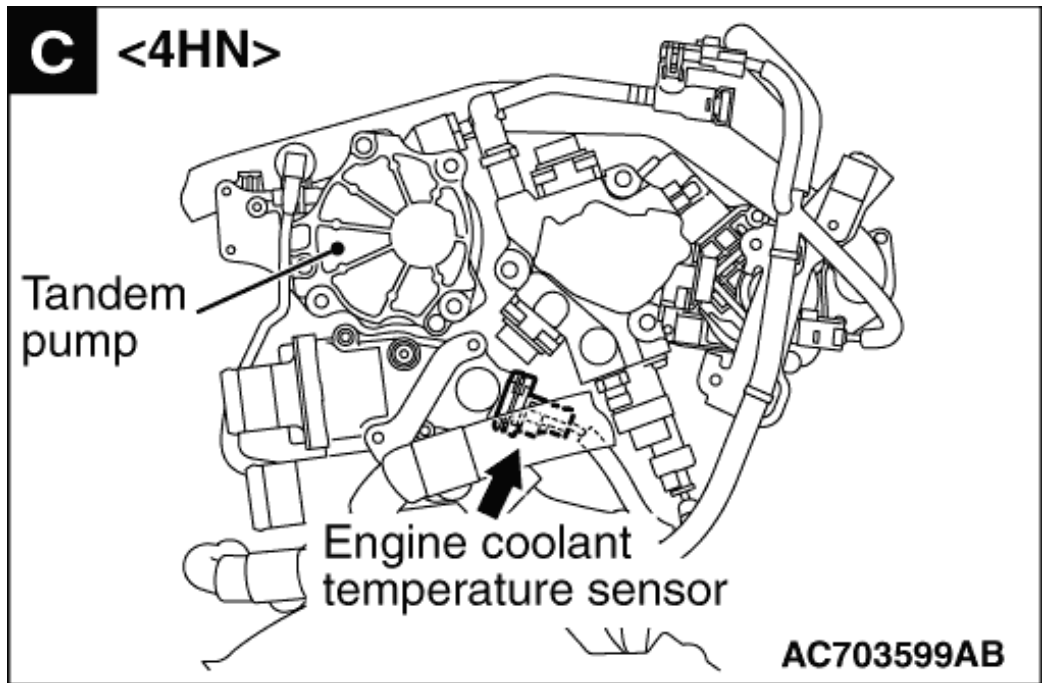
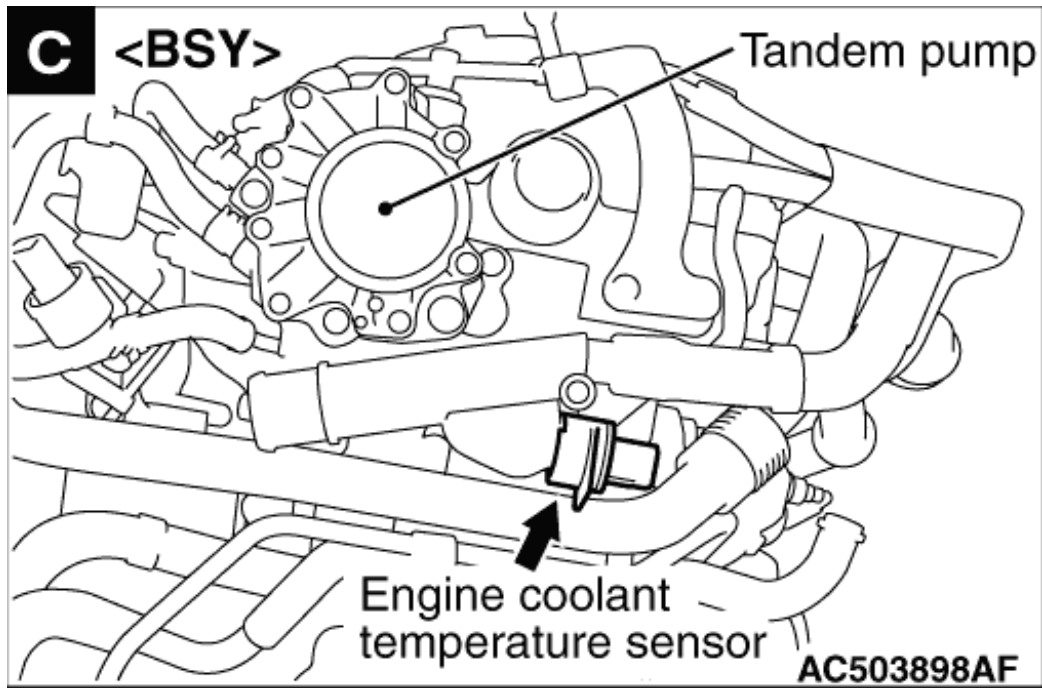

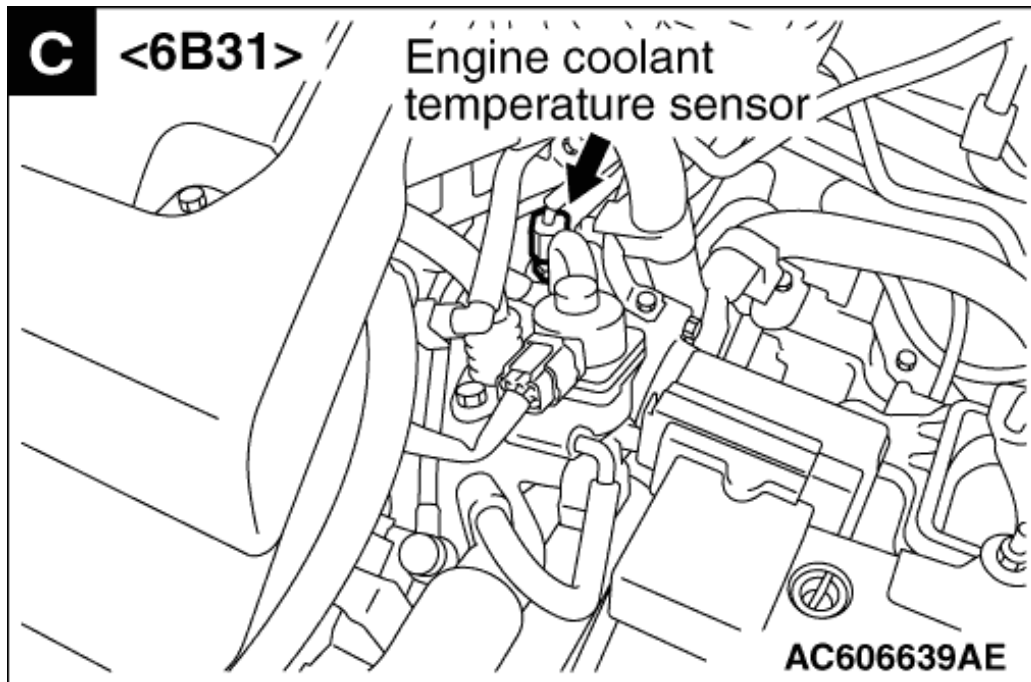
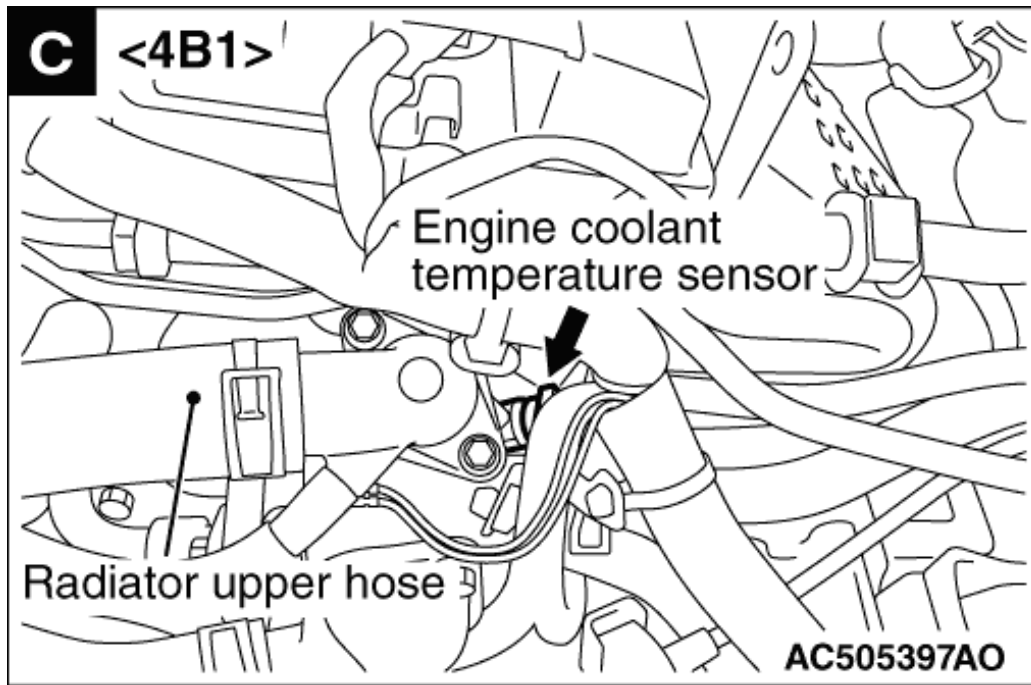

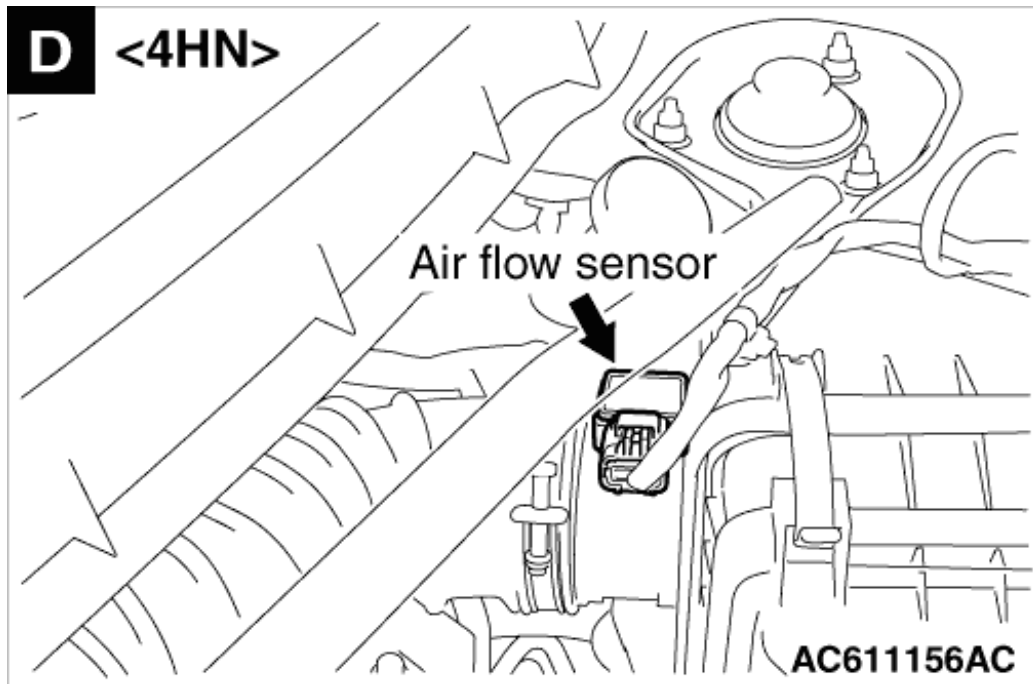
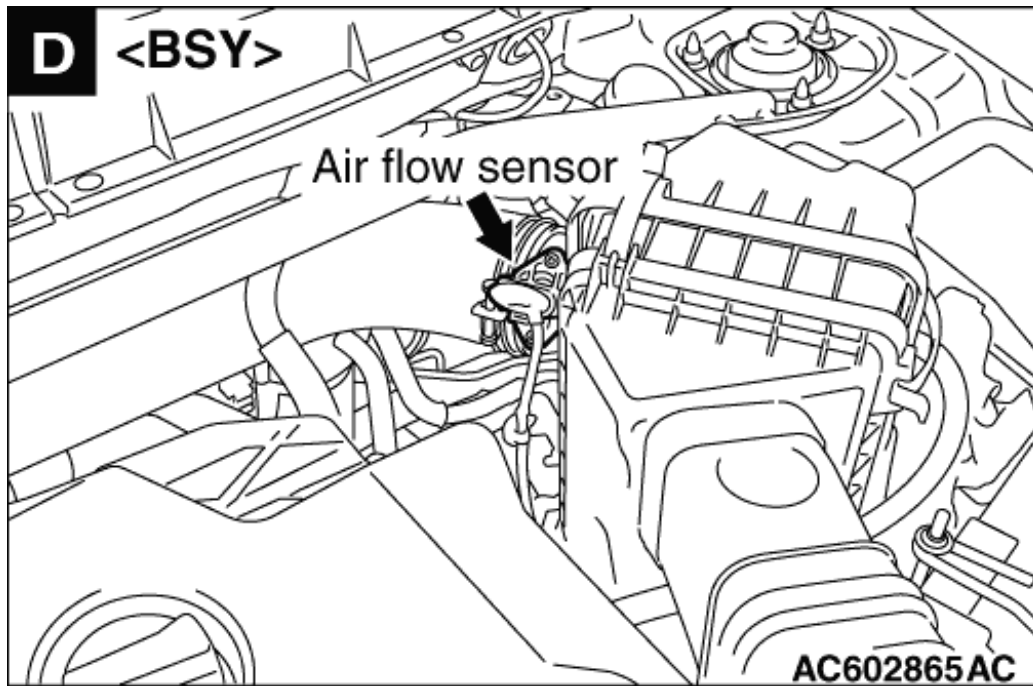

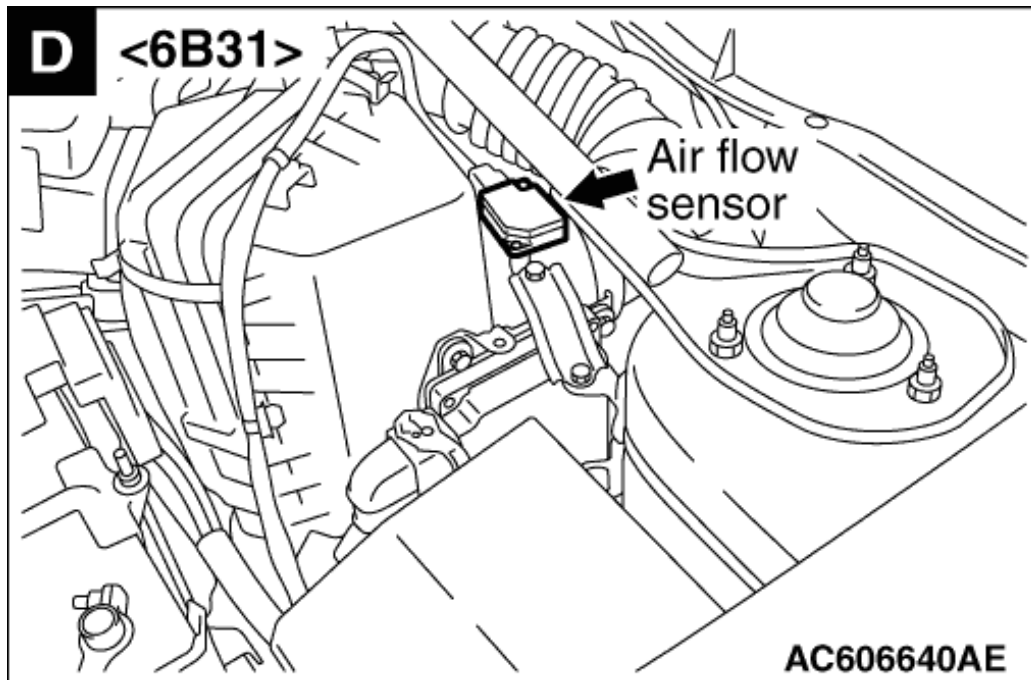
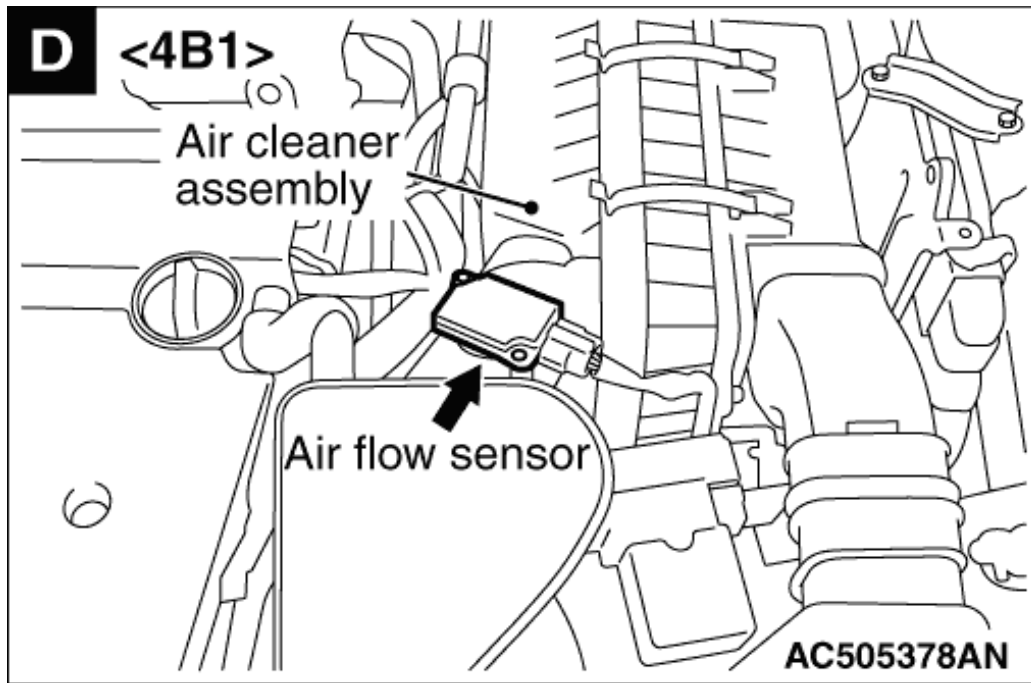

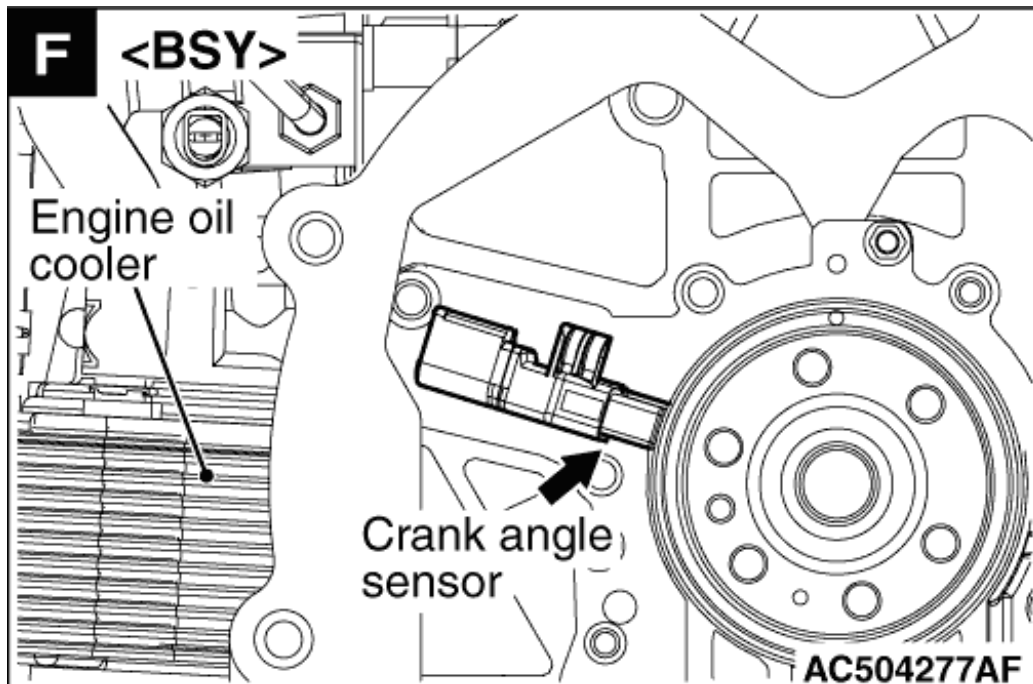
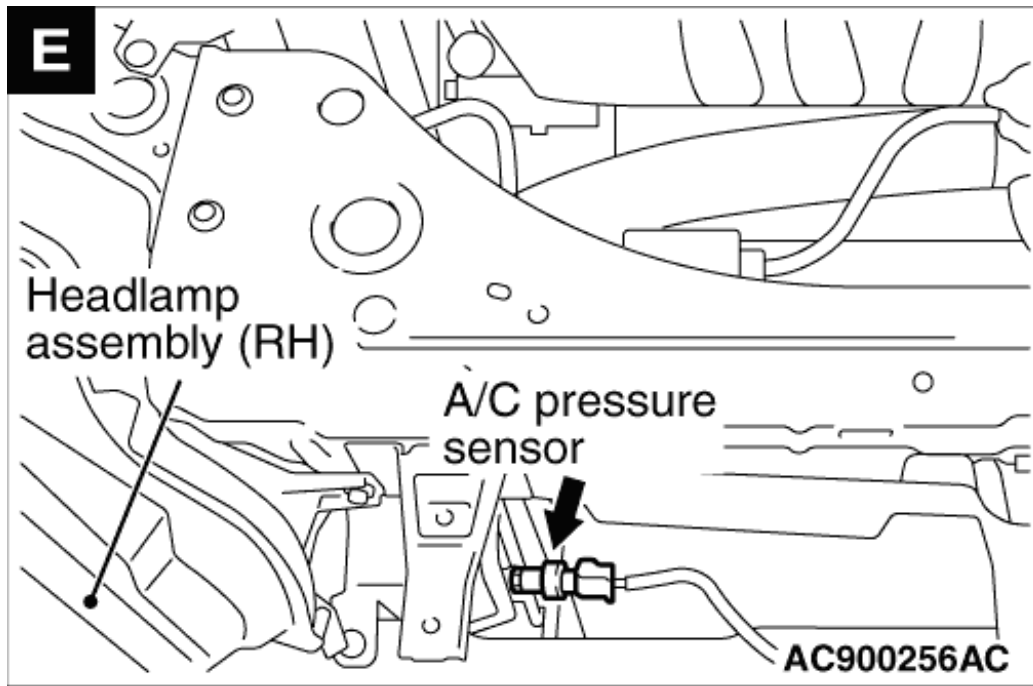

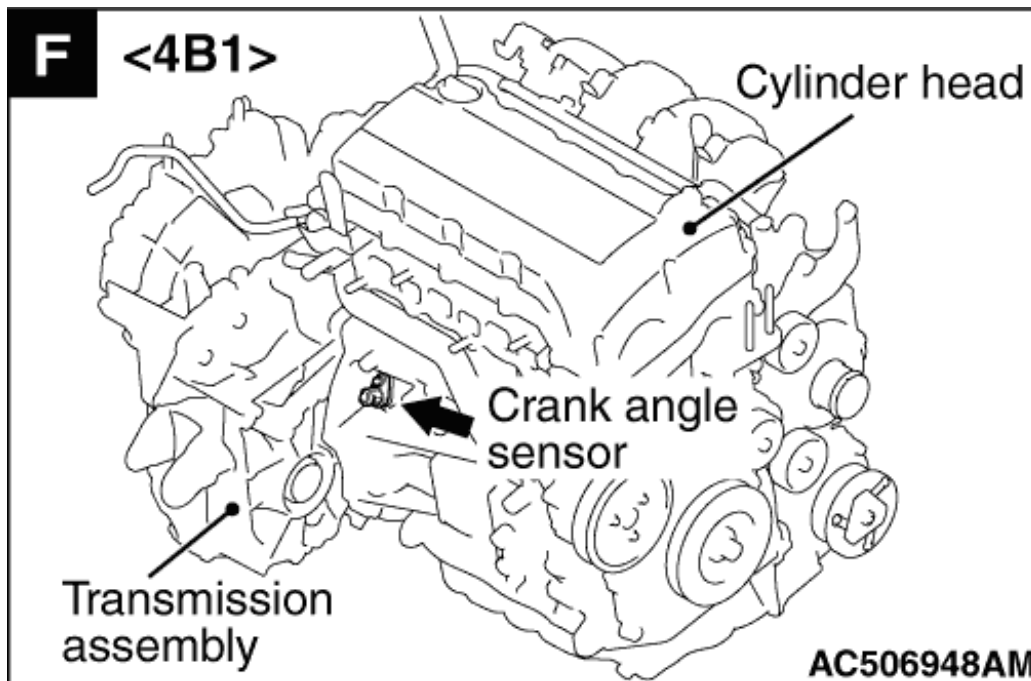
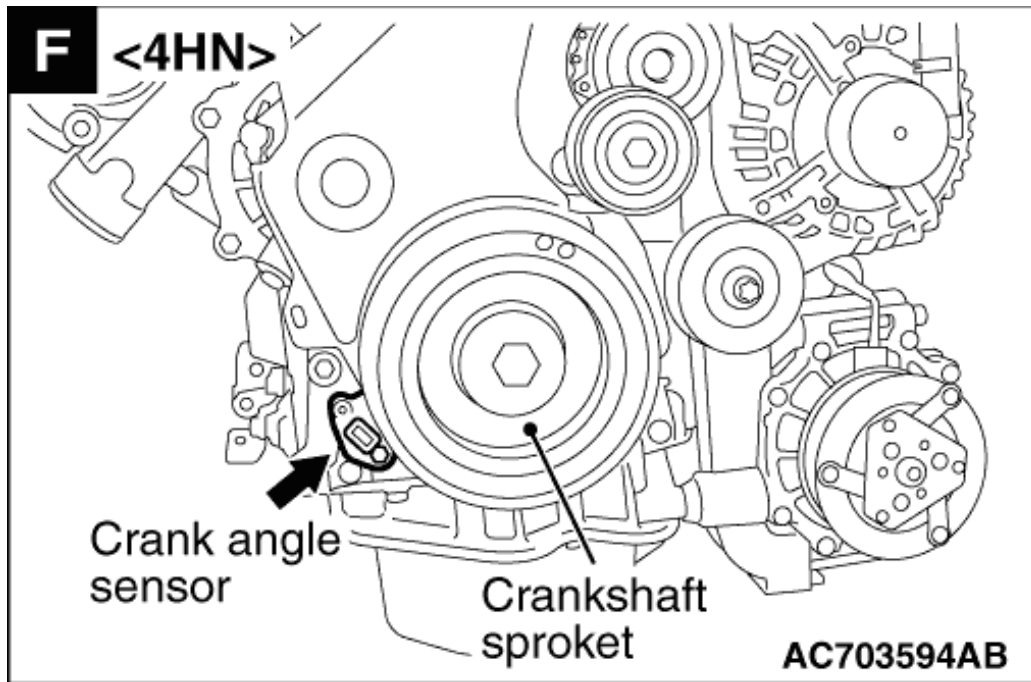

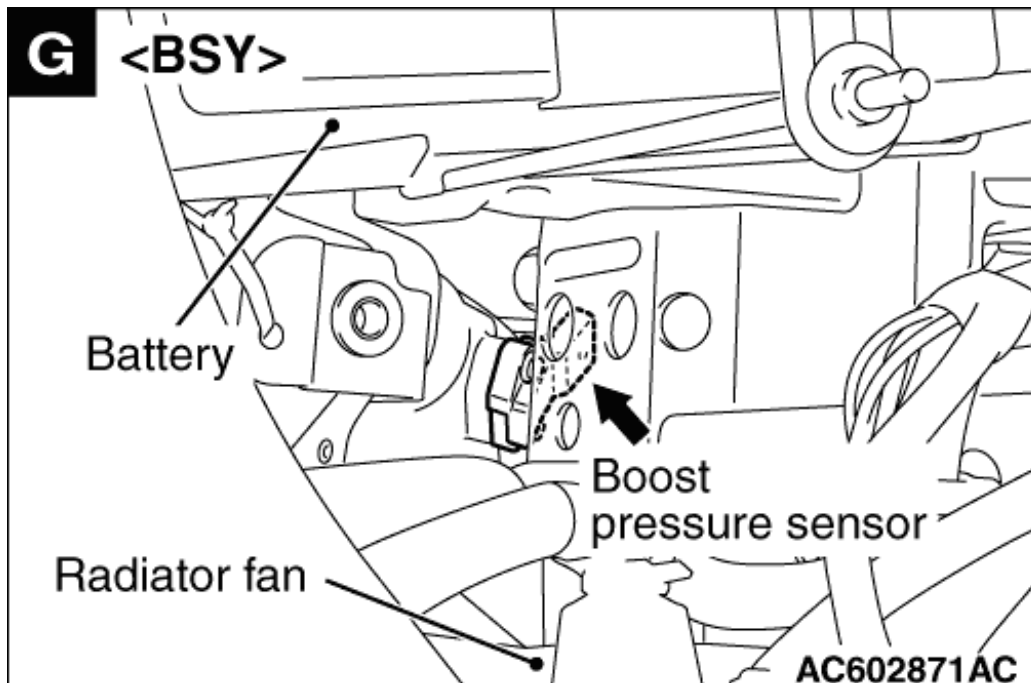
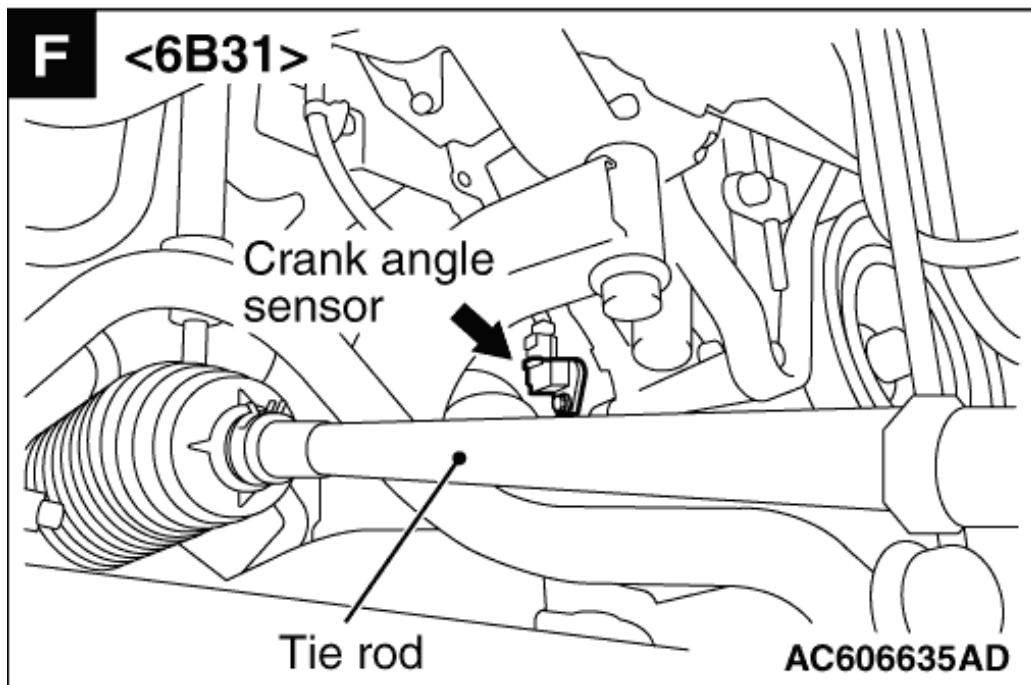

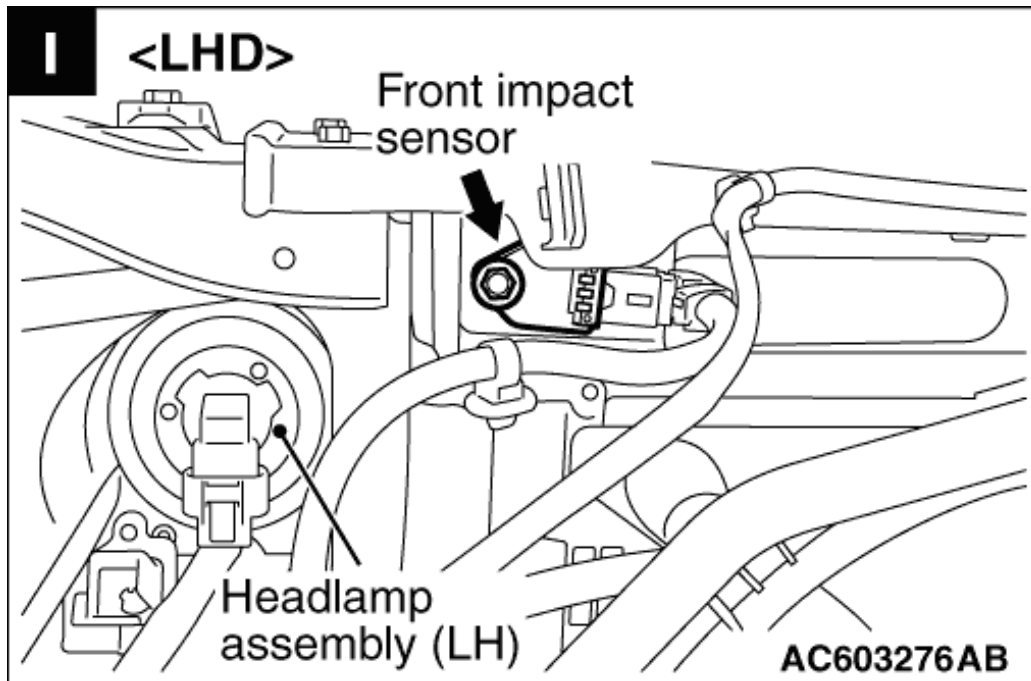
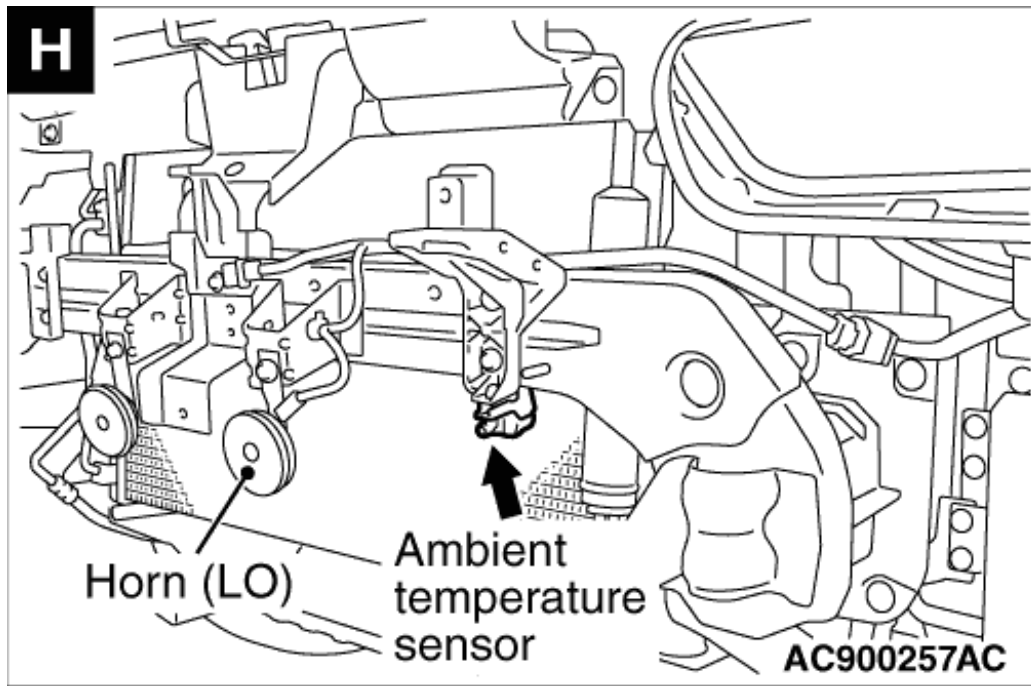

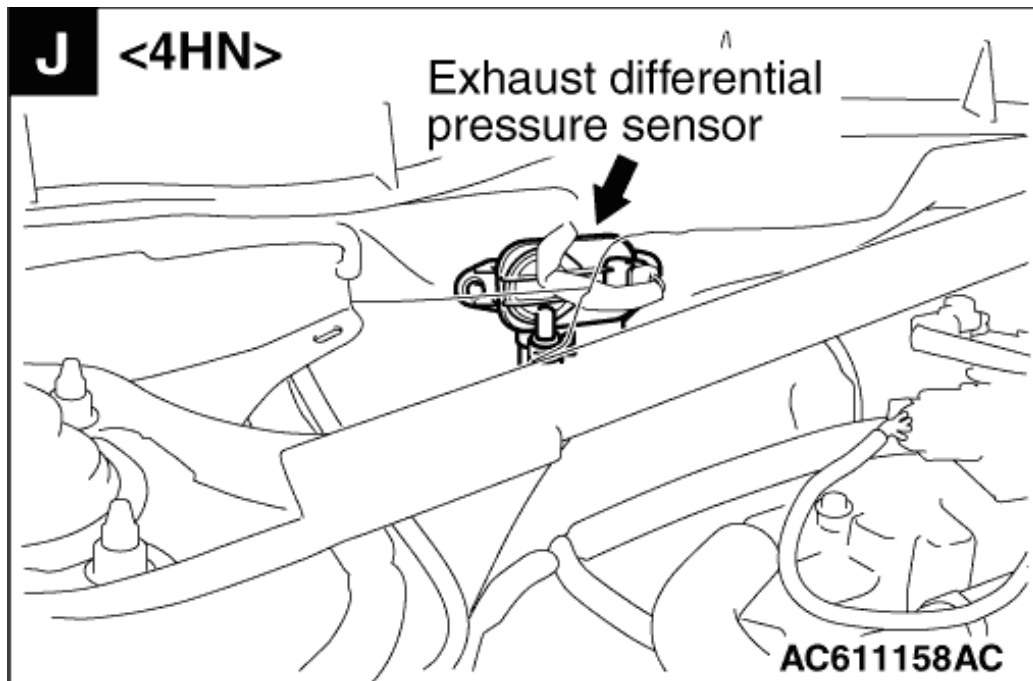
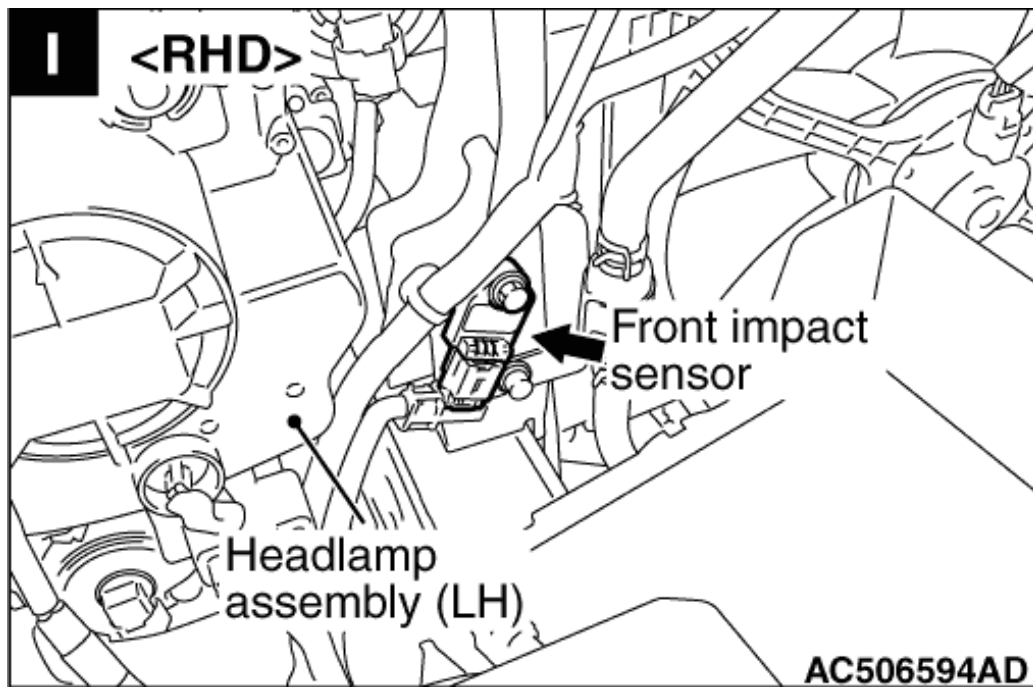

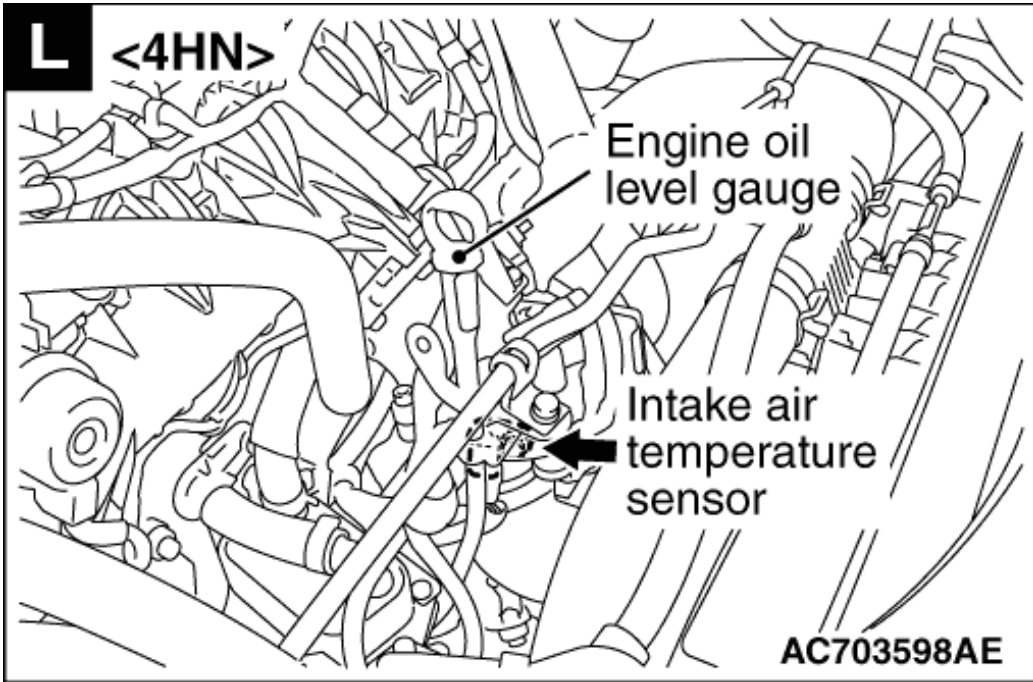
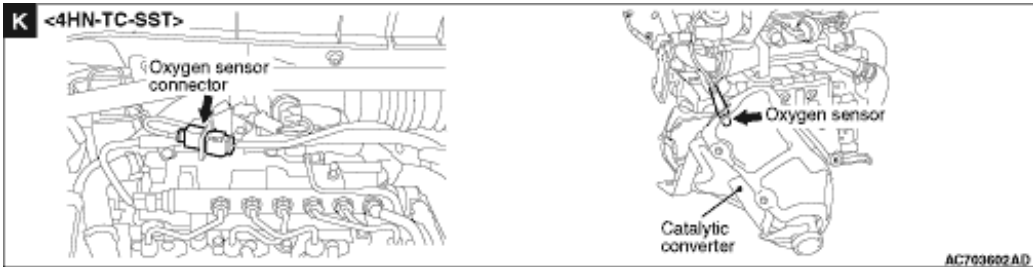

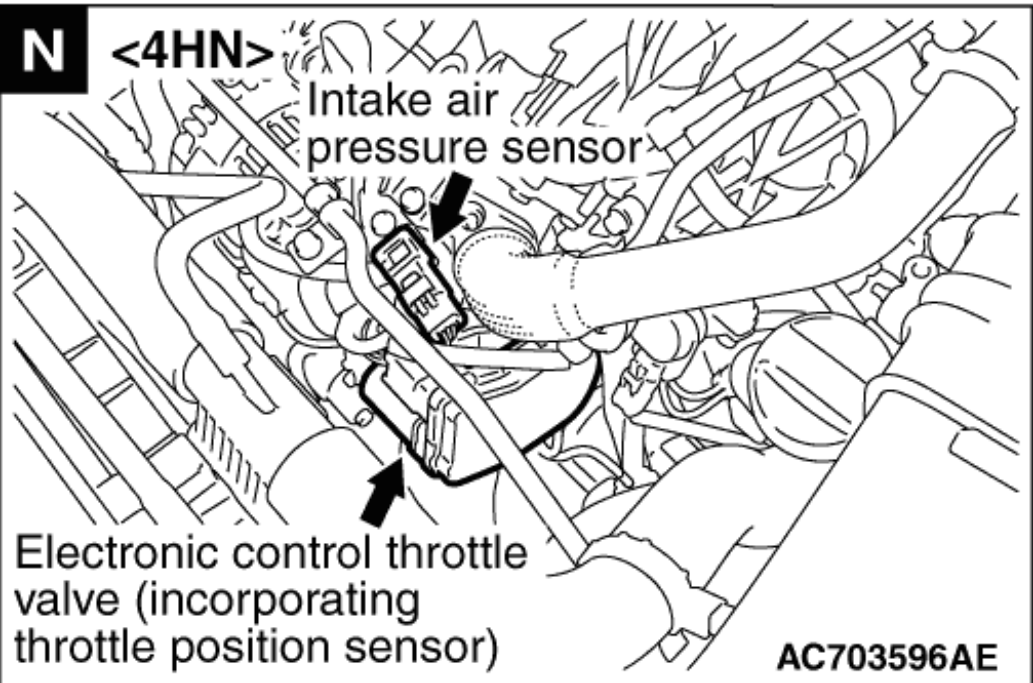
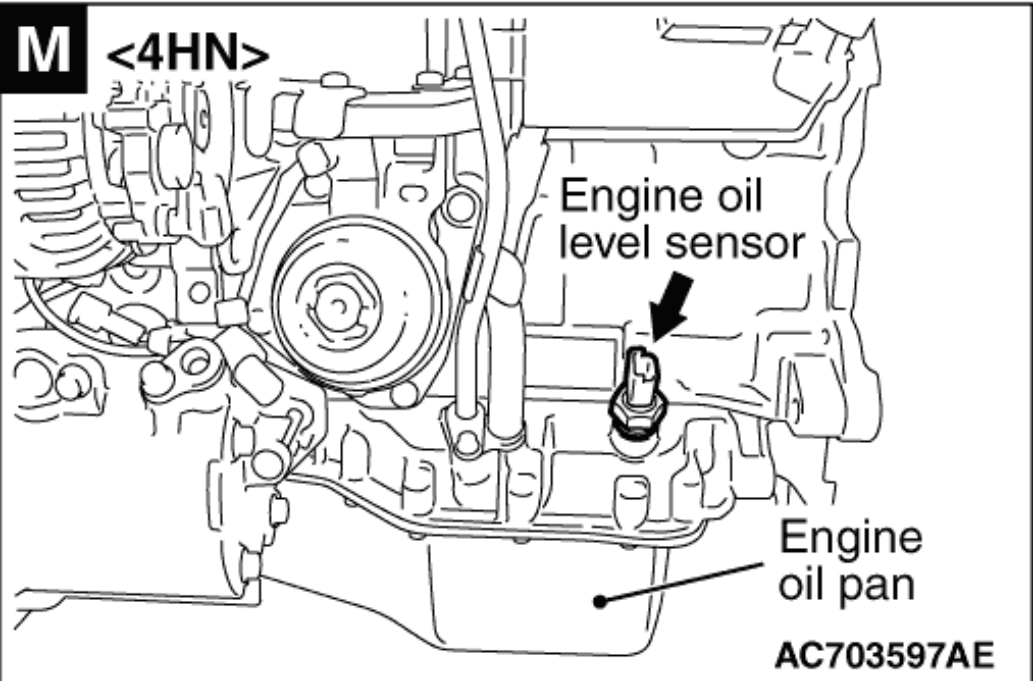

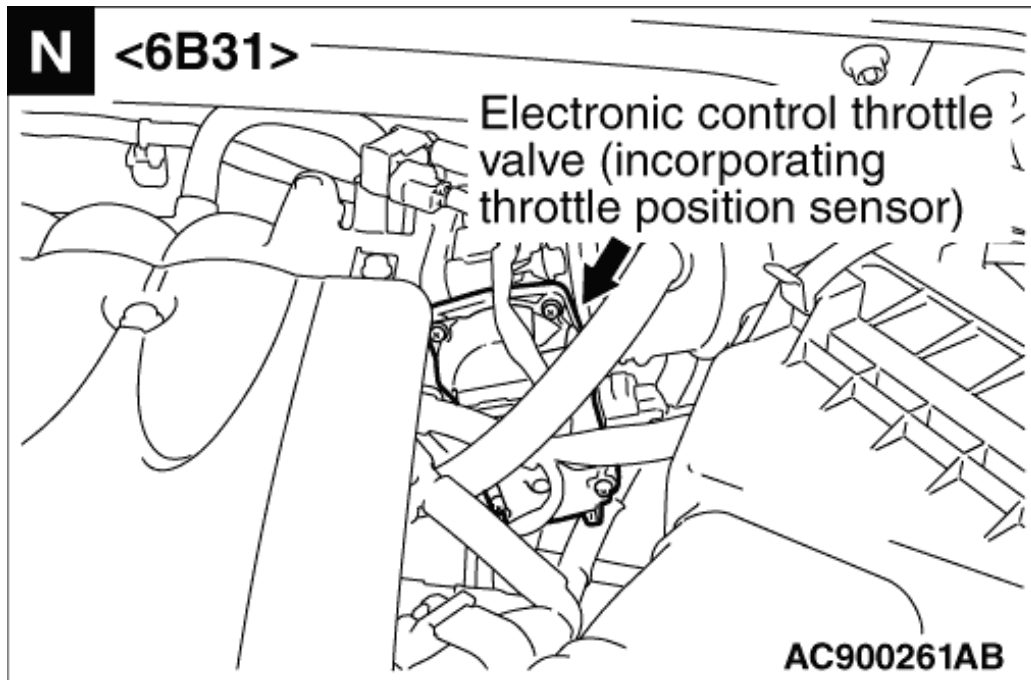
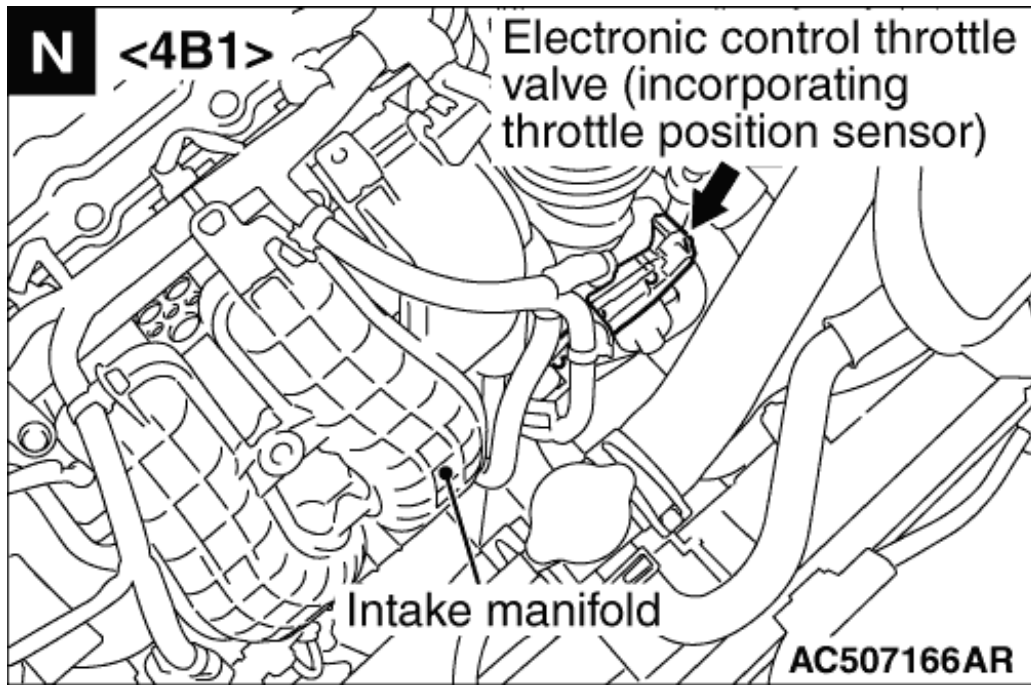

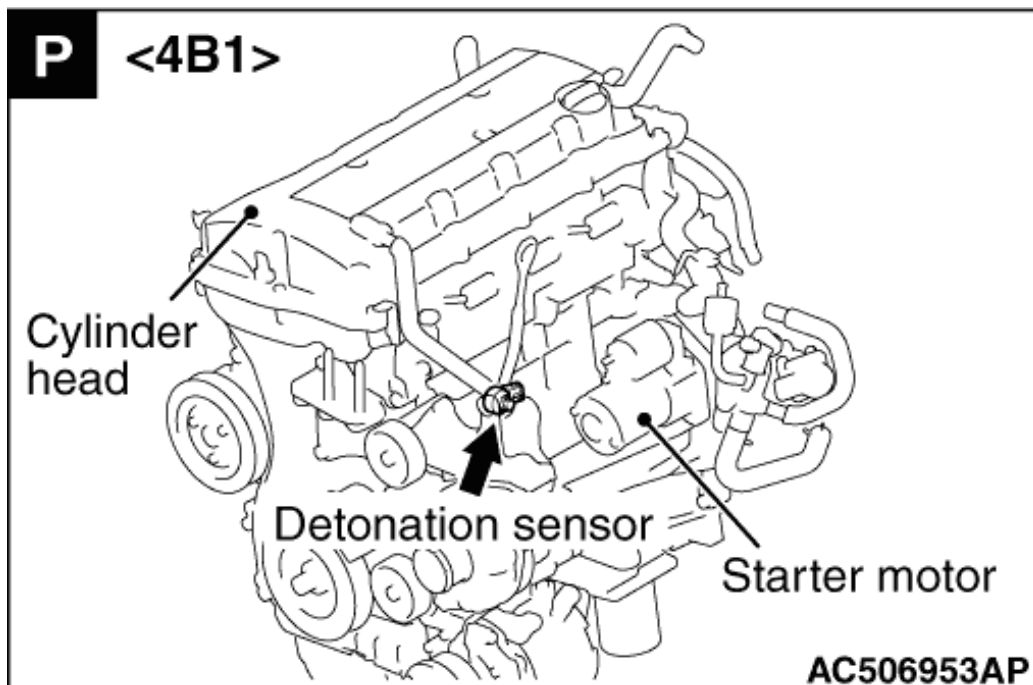
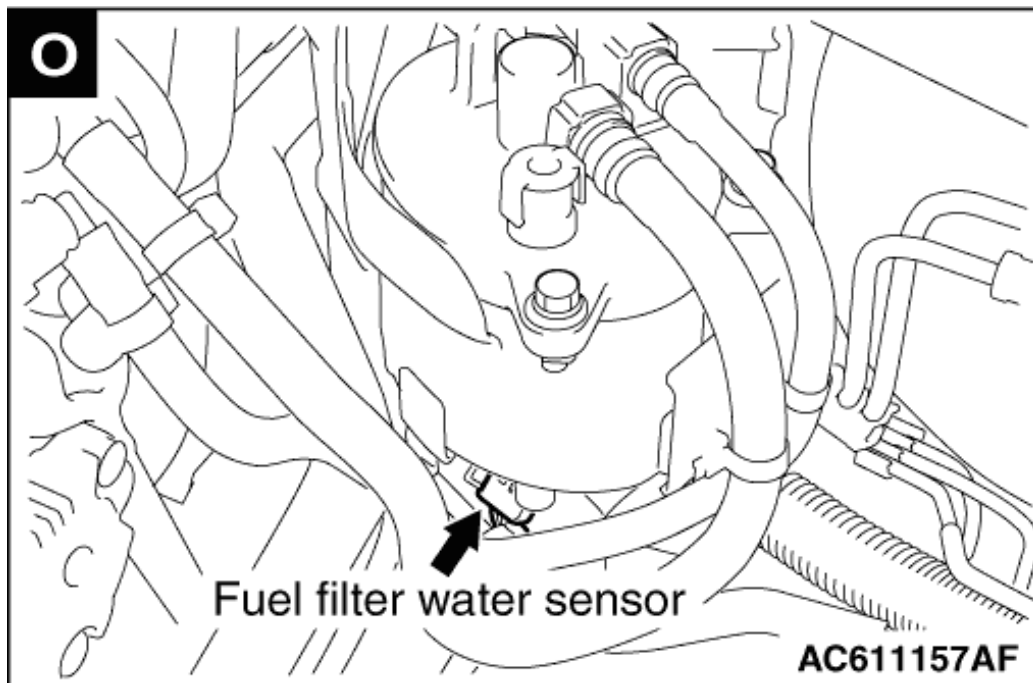

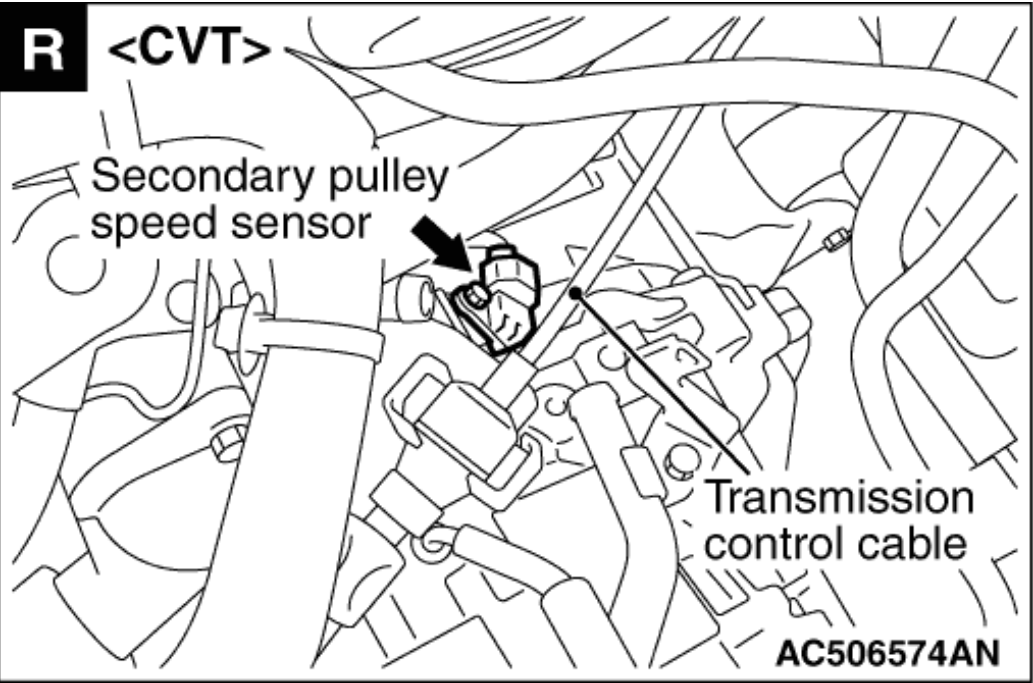
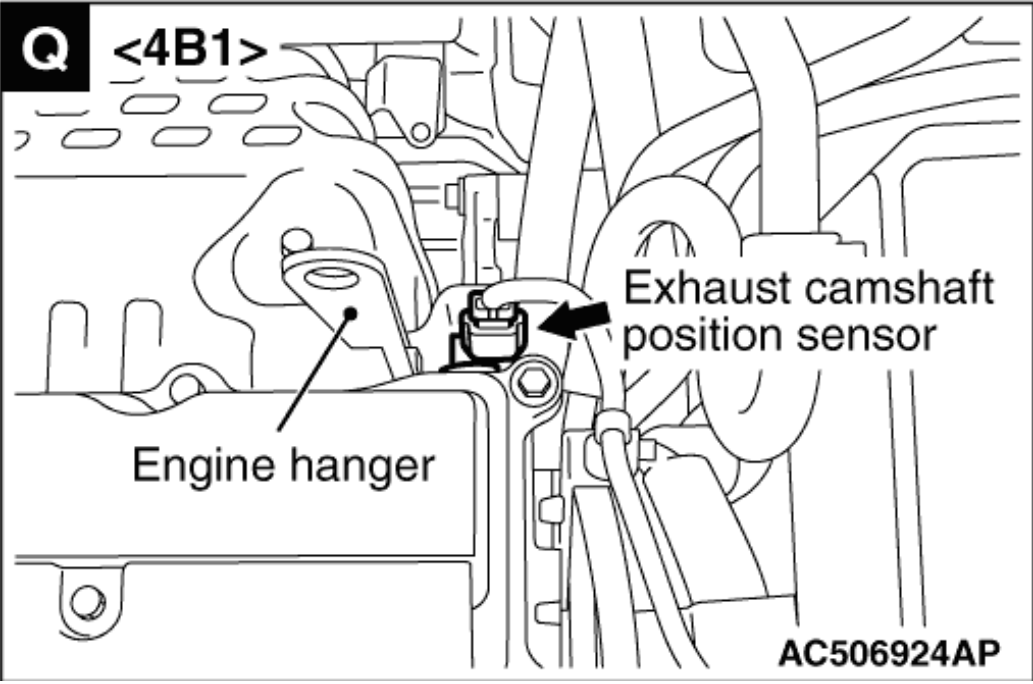

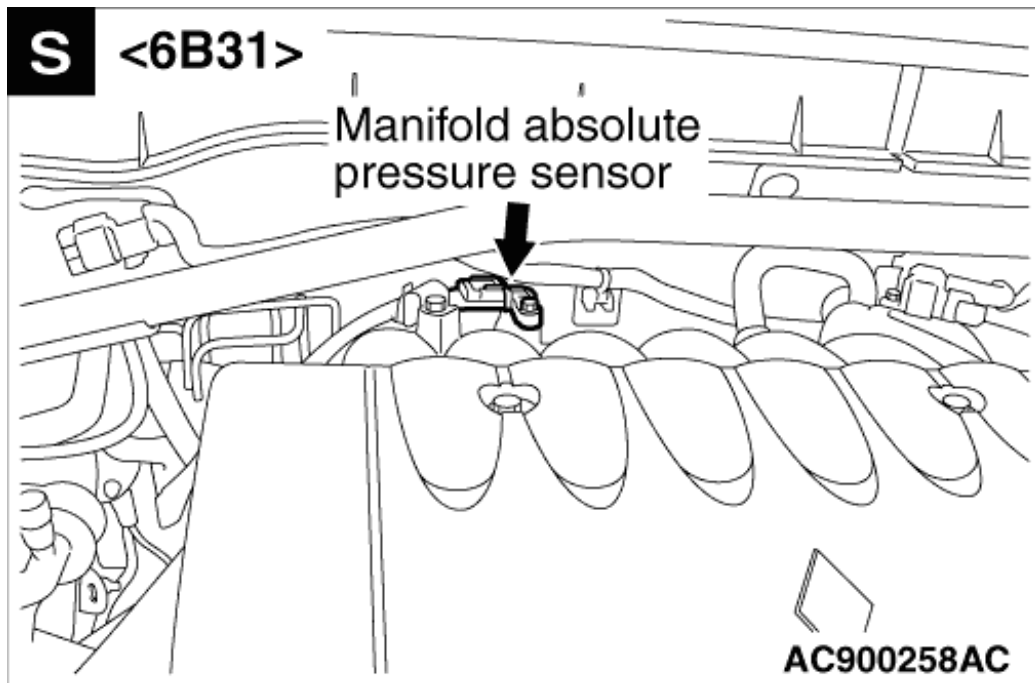
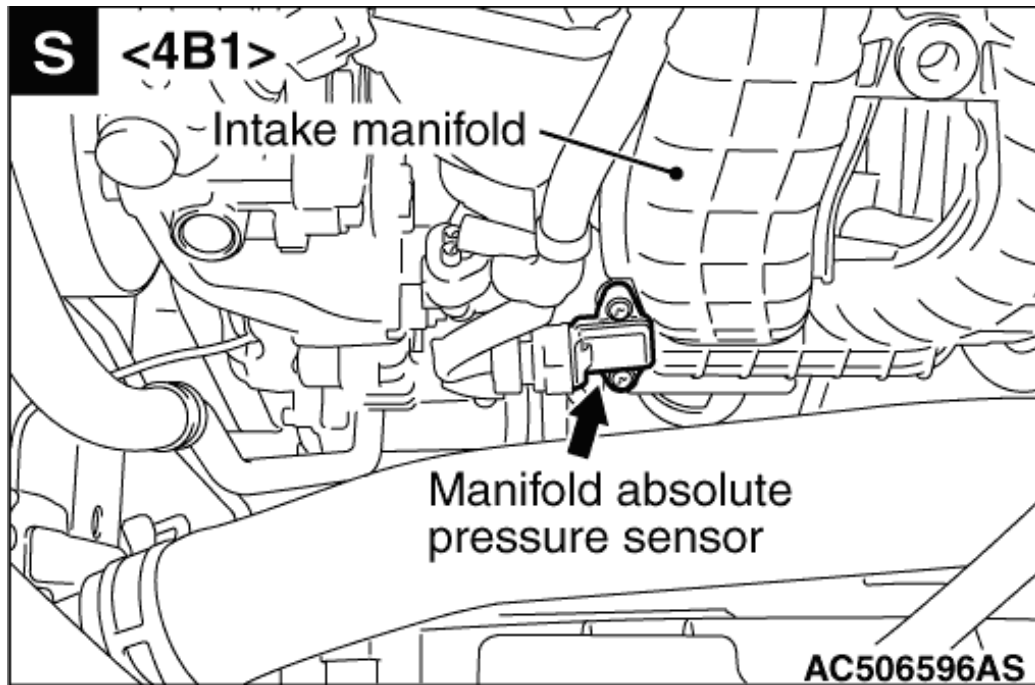

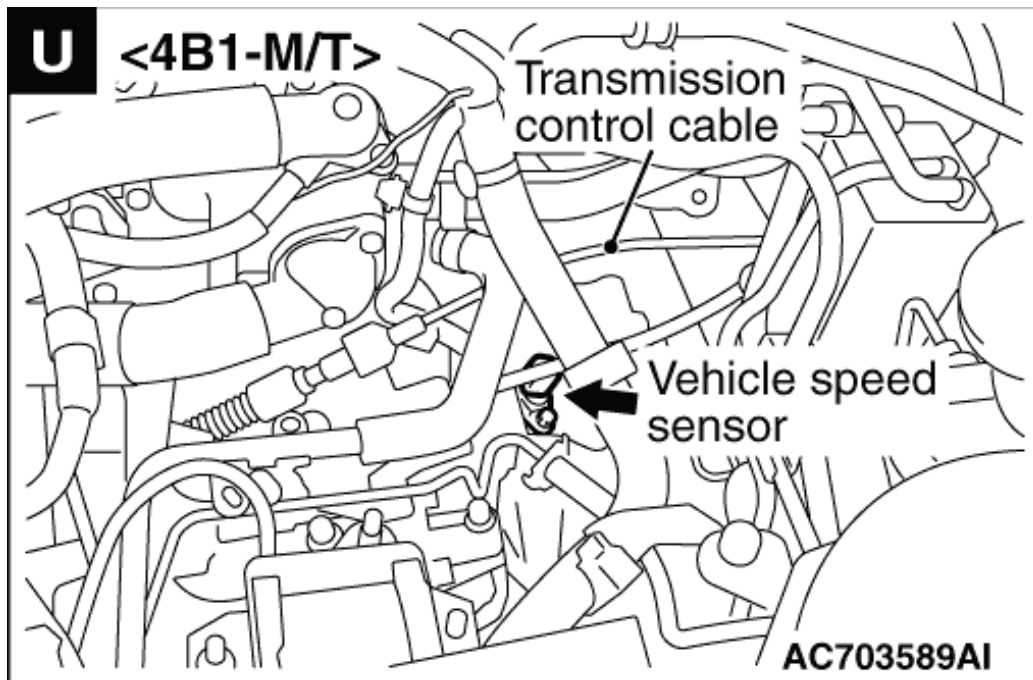
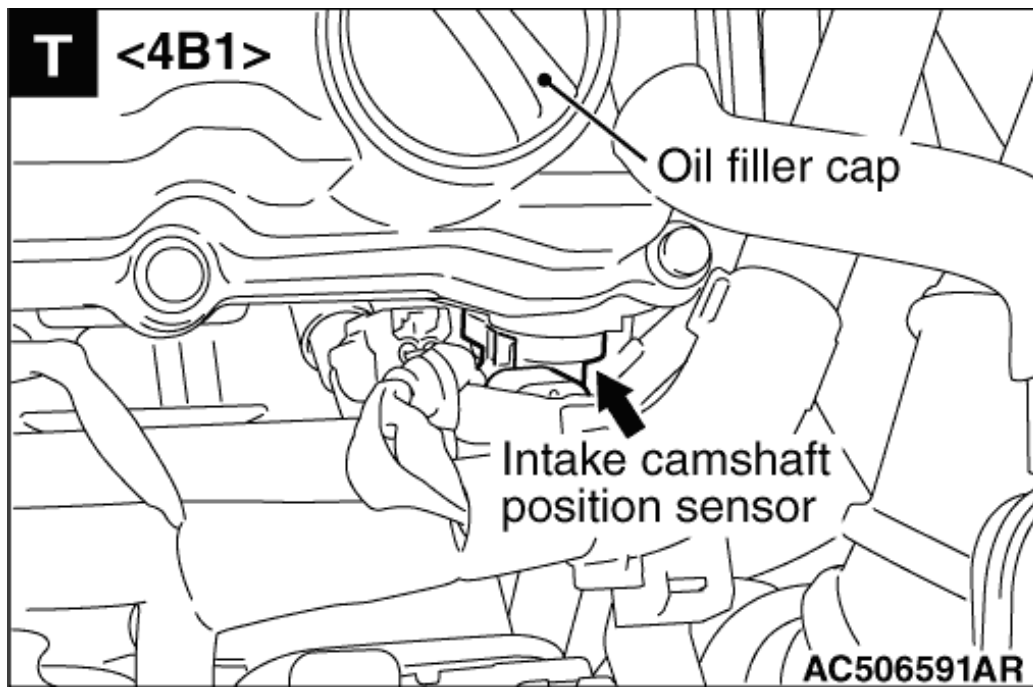

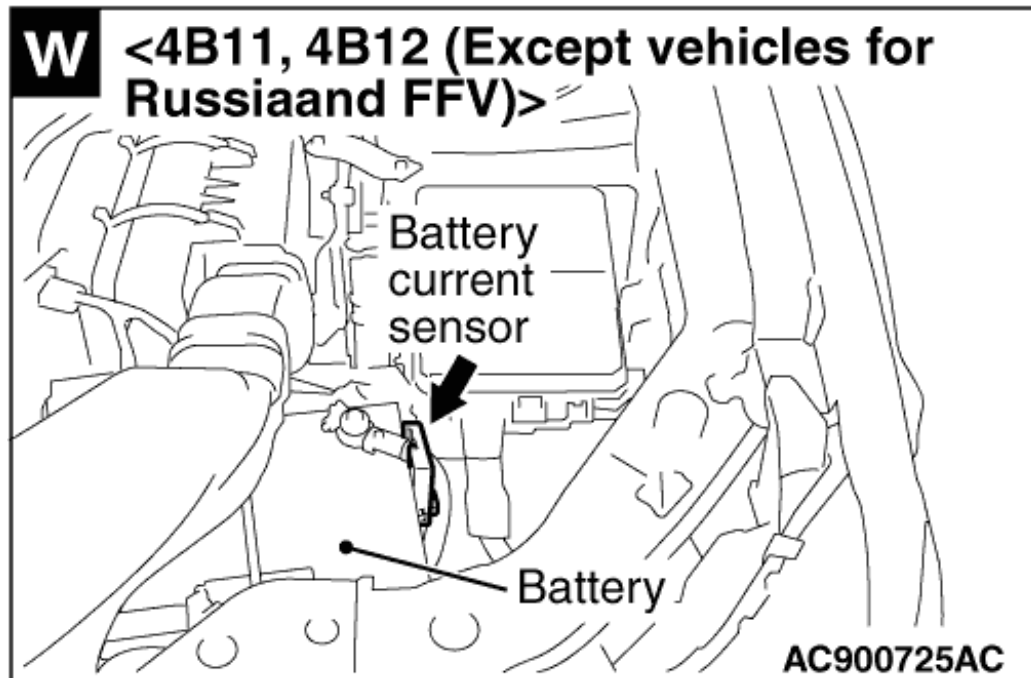
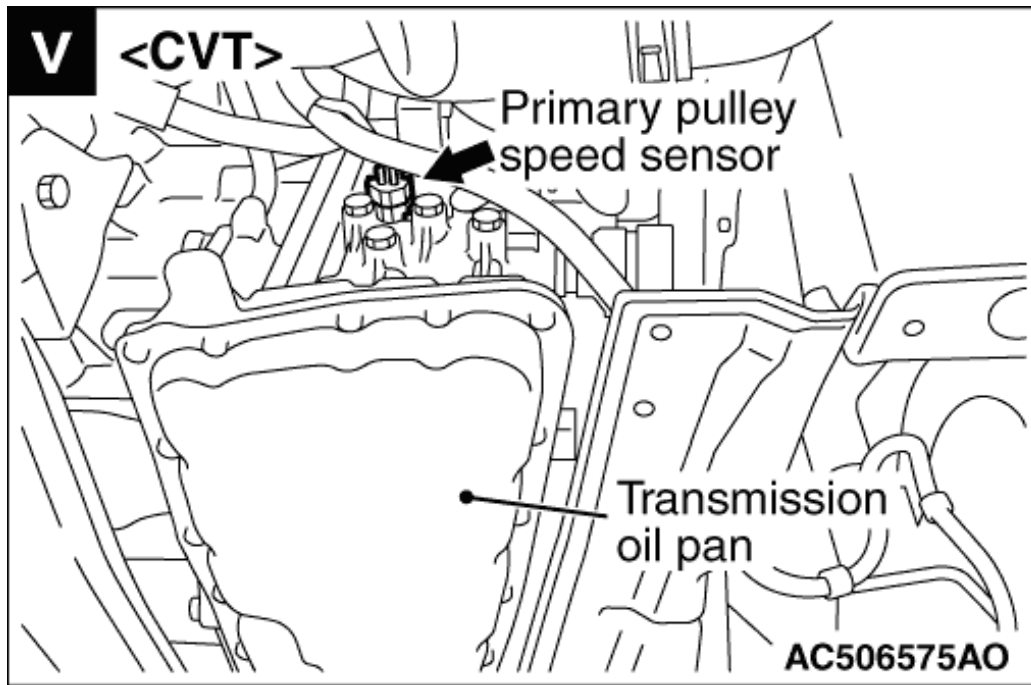

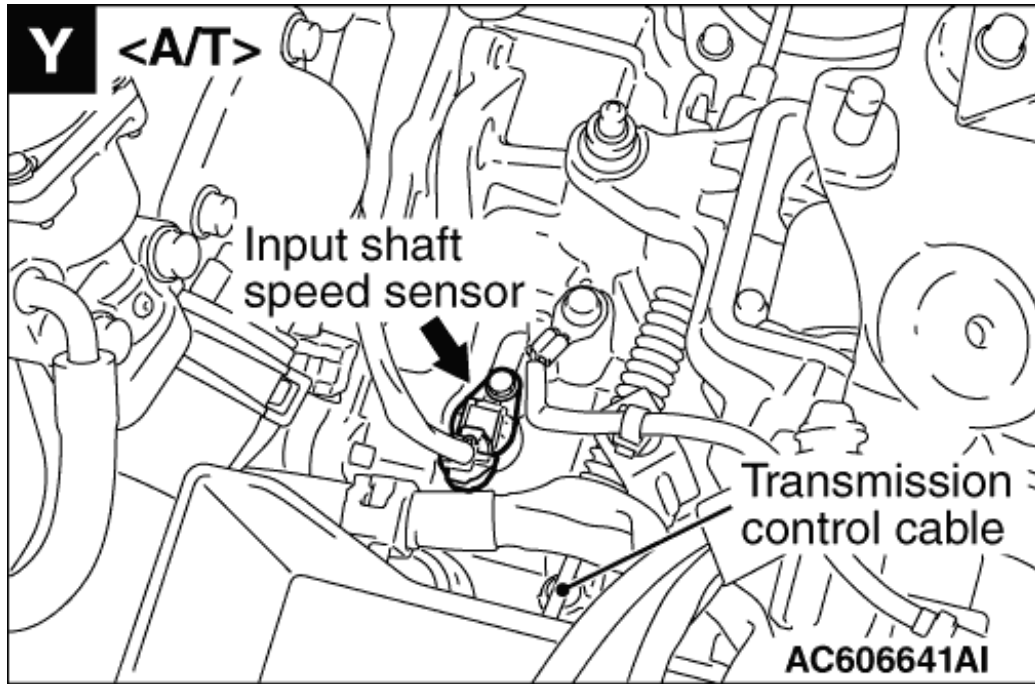
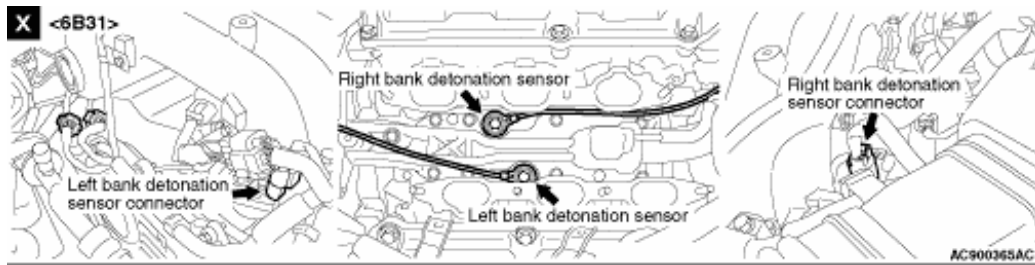

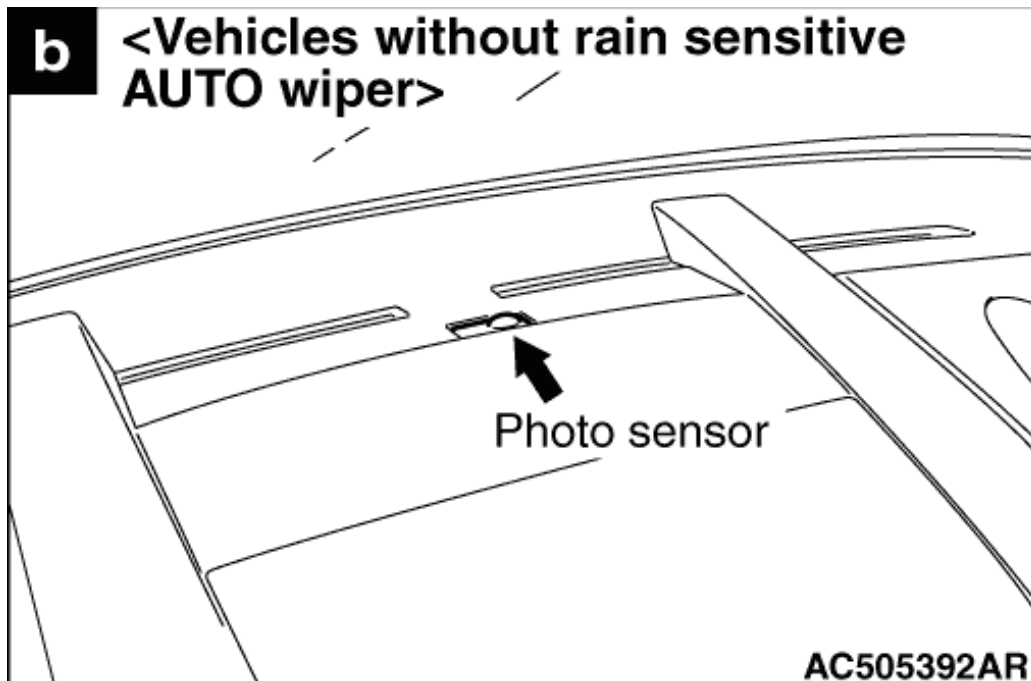
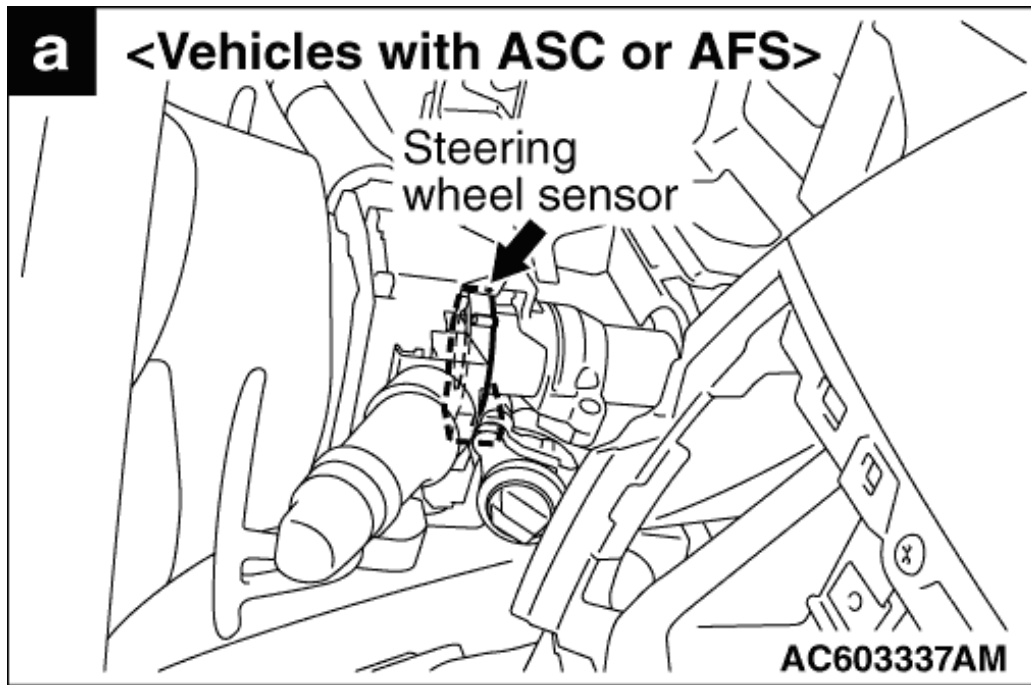

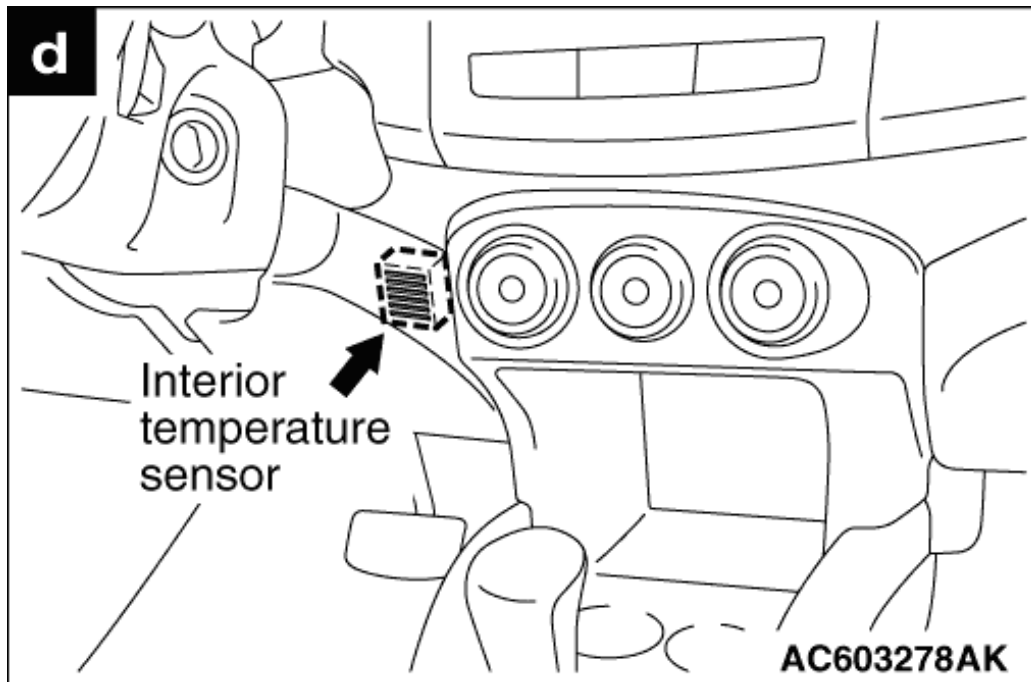
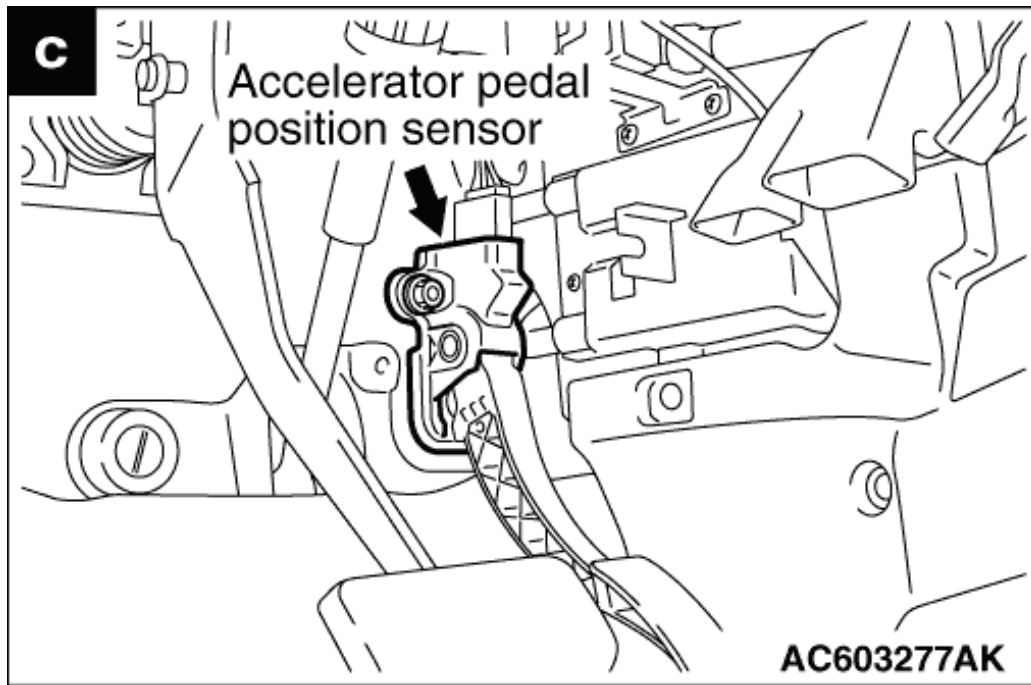

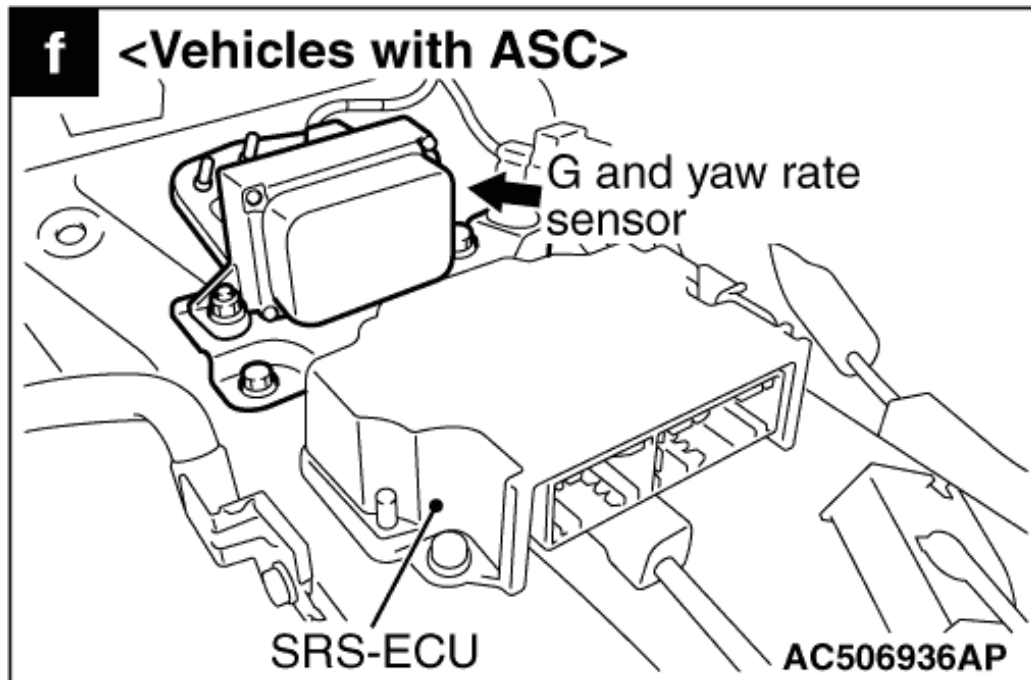
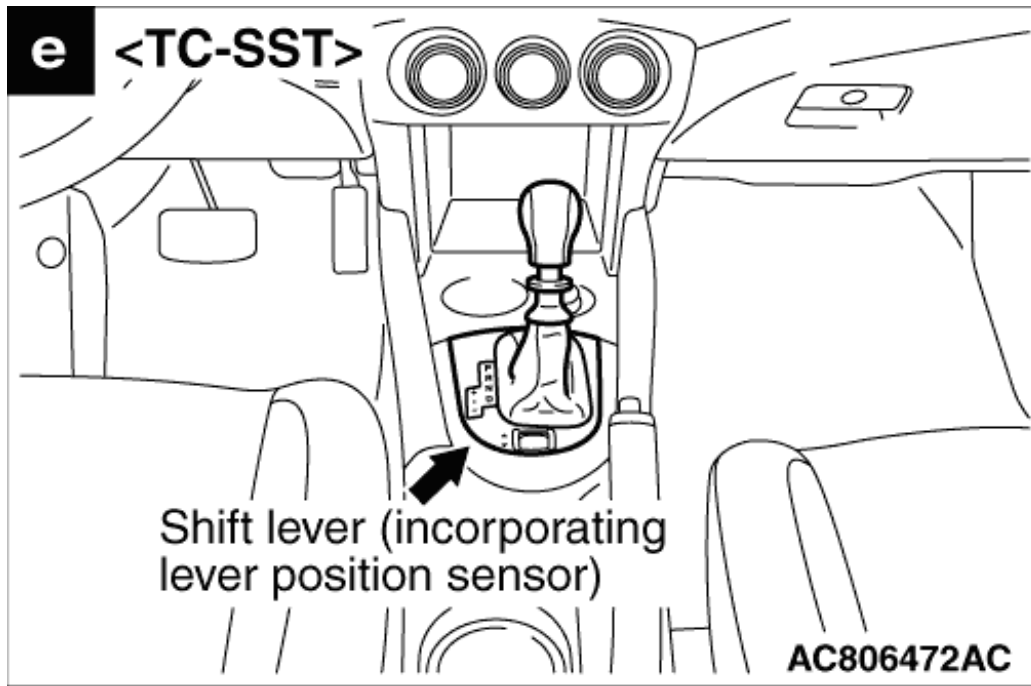

g

Fin thermo sensor

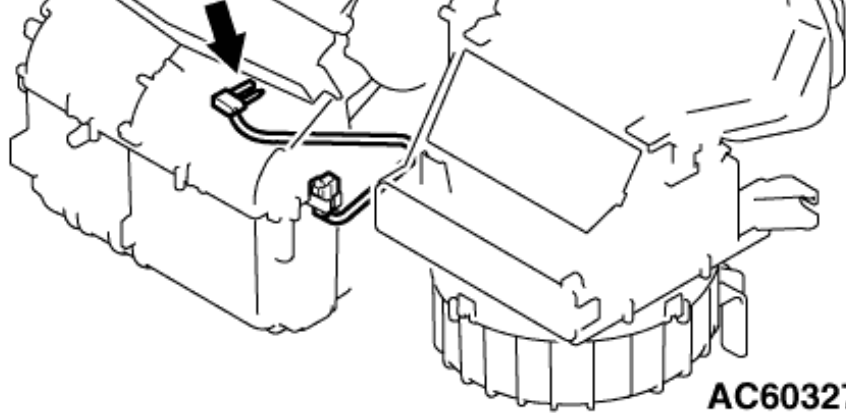

AC603279AK

h <6B31>

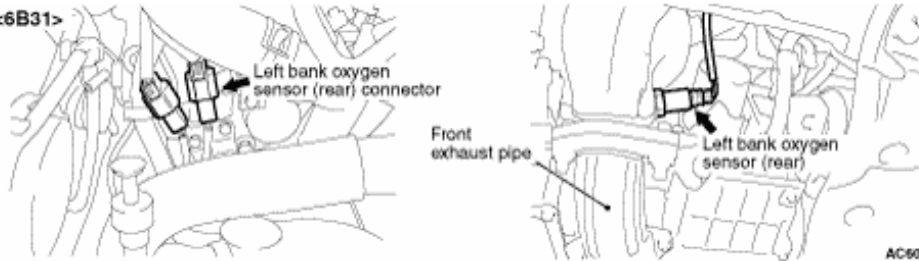

AC606644AJ

i <Vehicles with headlamp automatic levelling system>

Front height sensor

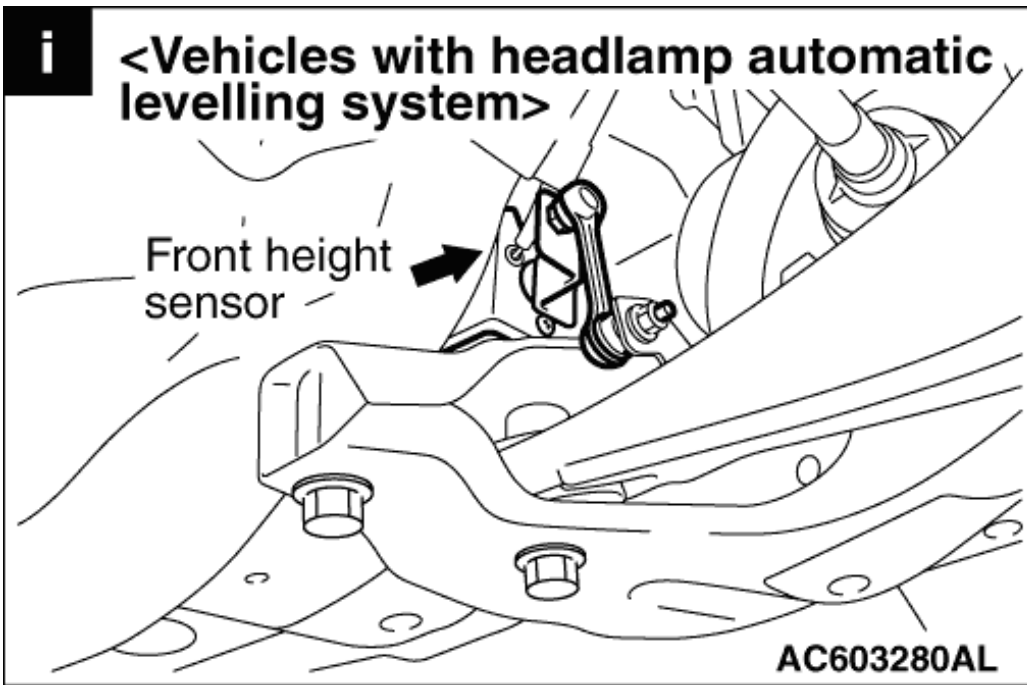

AC603280AL



k <Vehicles with rain sensitive AUTO wiper>

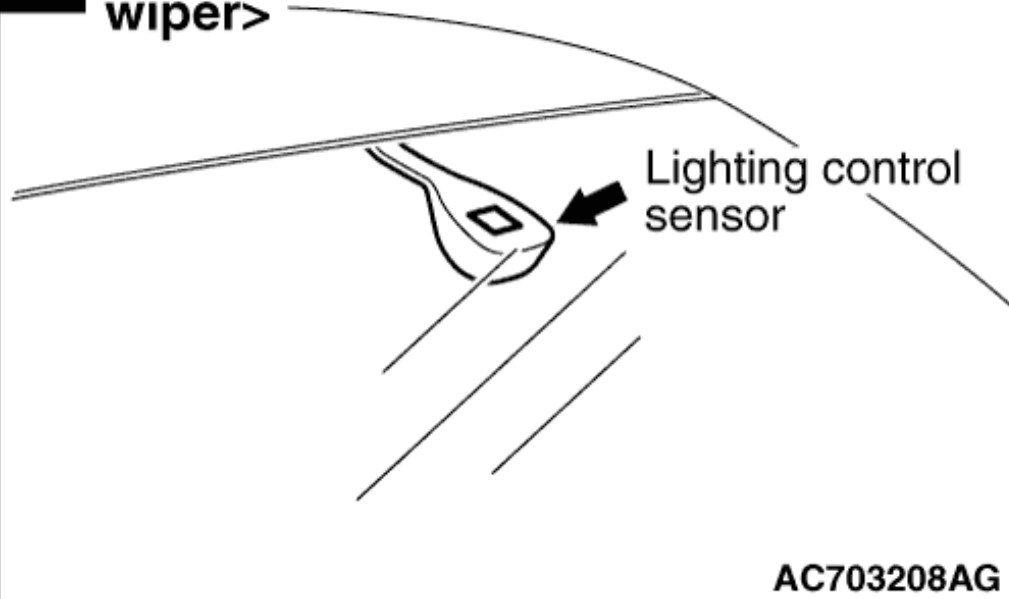

n <Vehicles with KOS>

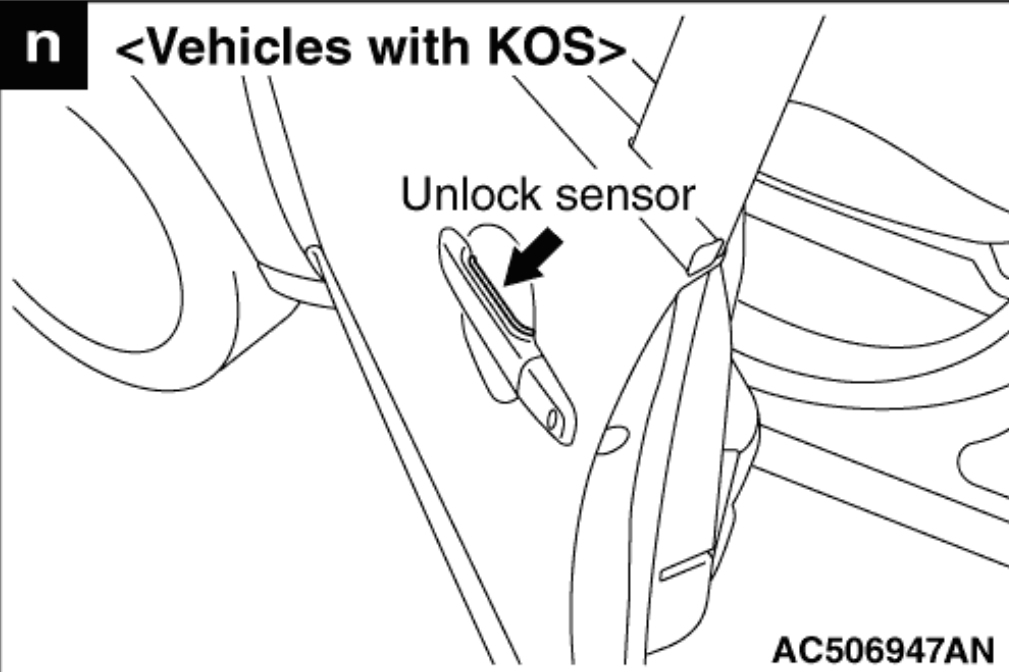

o <Vehicles with headlamp automatic levelling system>

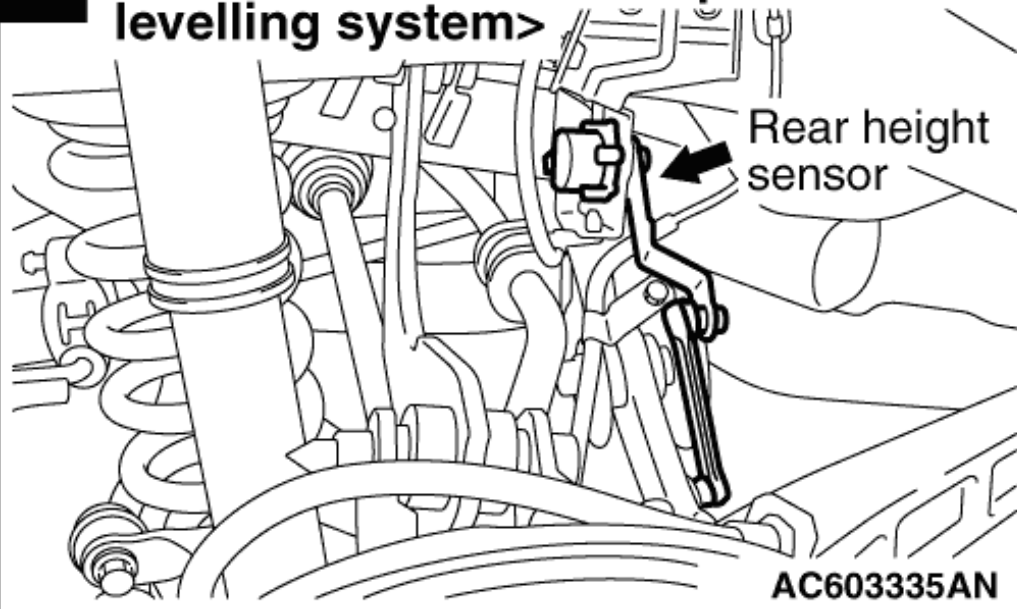

p Second seat belt retractor (LH)

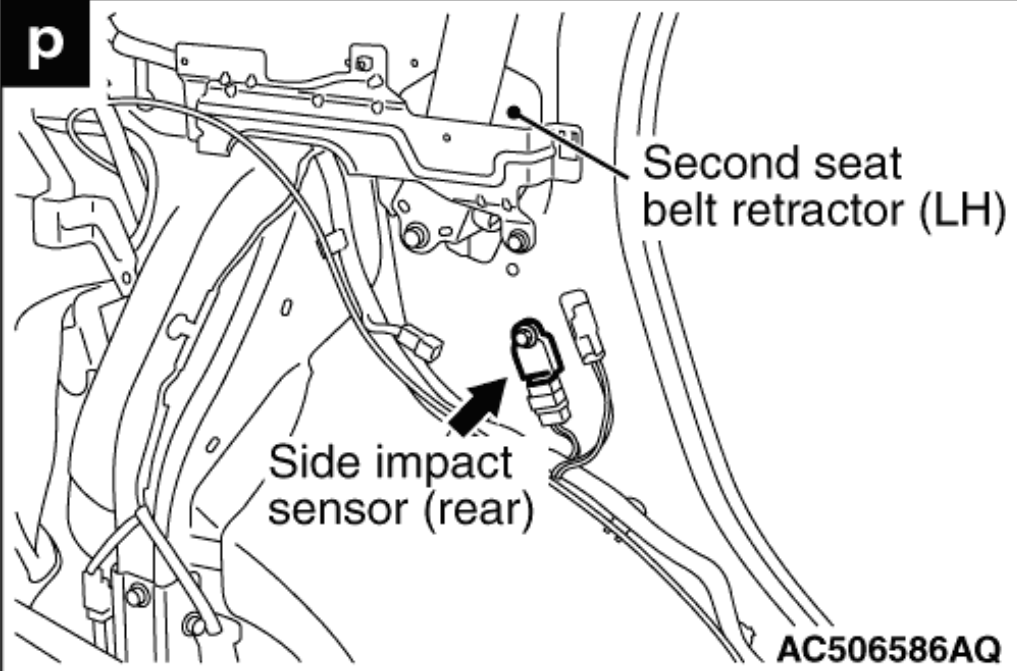

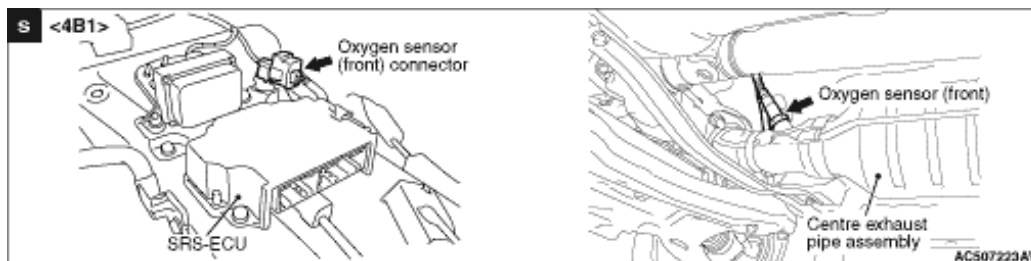
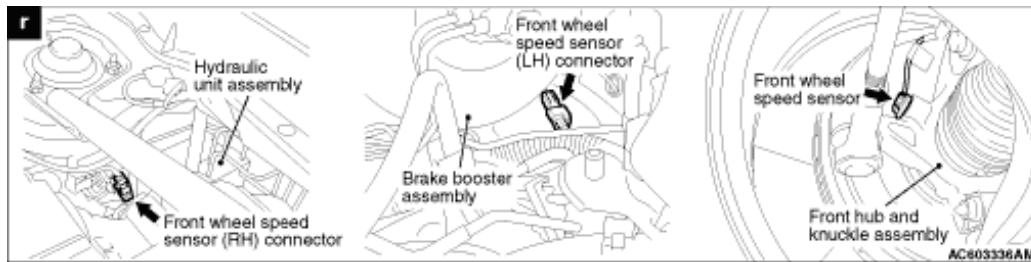
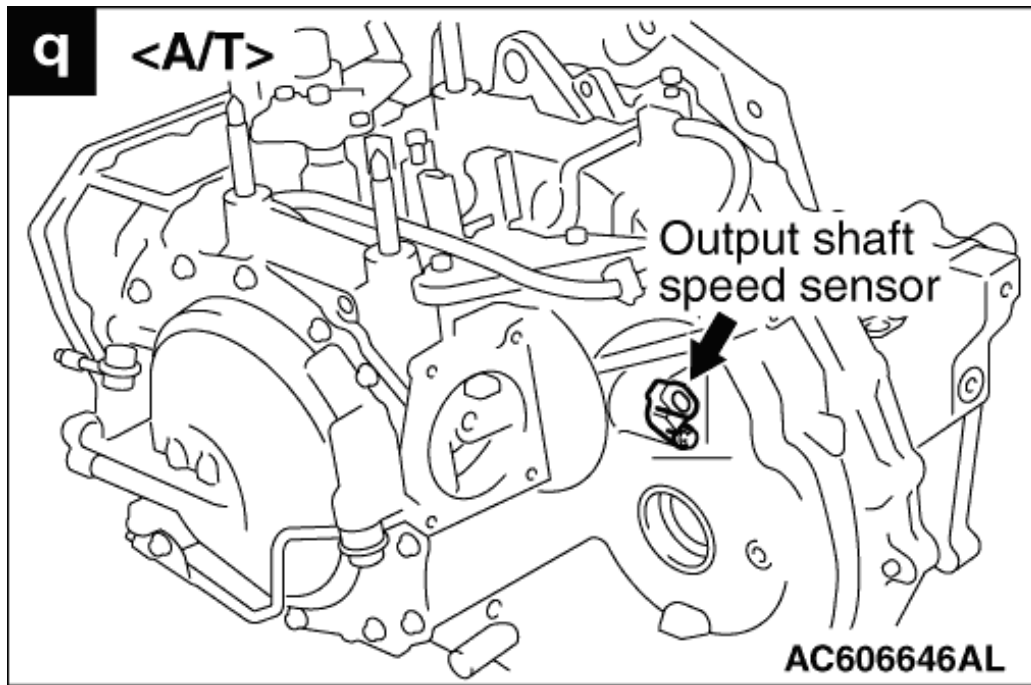

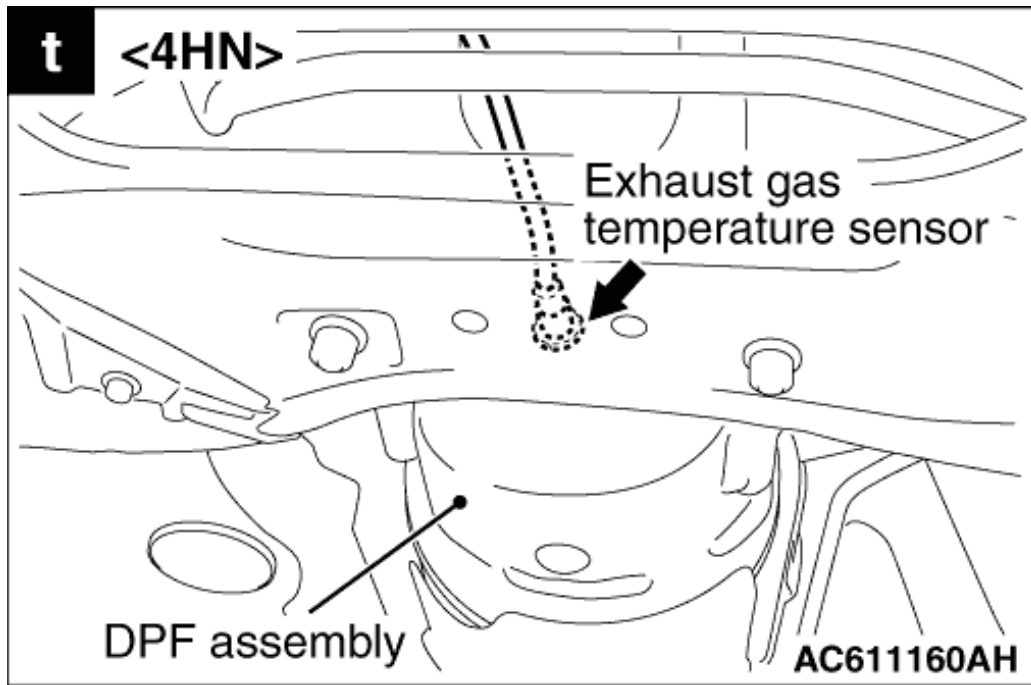

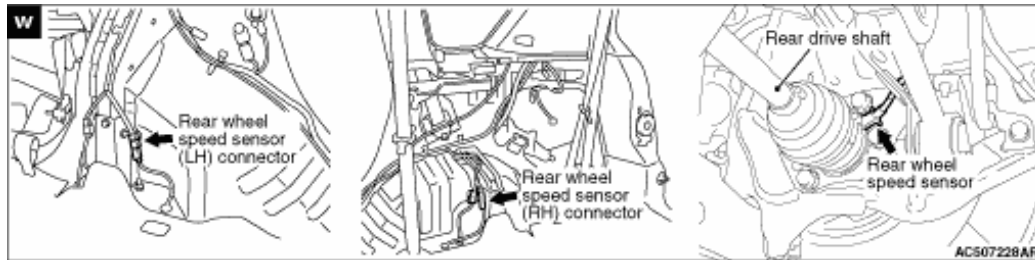
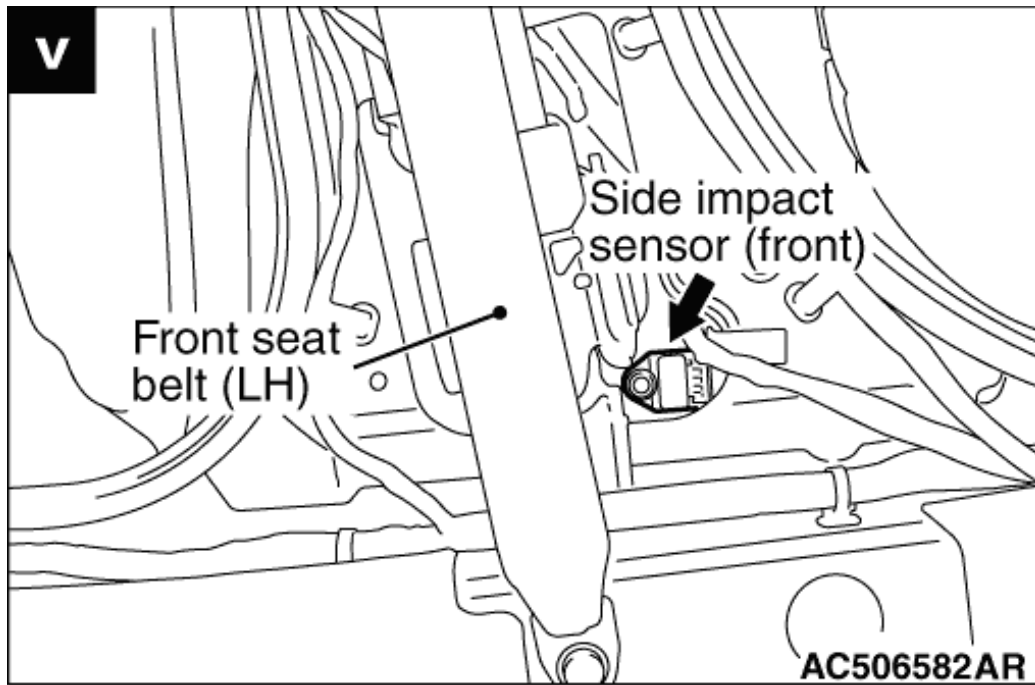

X

<Vehicles with reversing sensor system

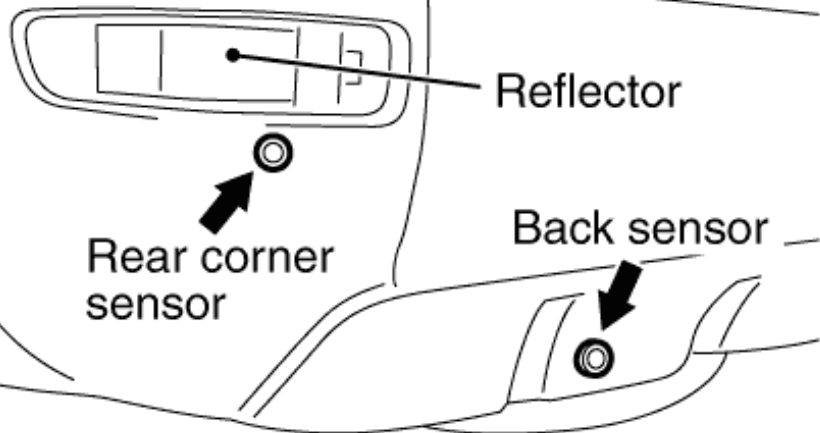

AC602868AN