

EARTH

<BSY, 4HN>

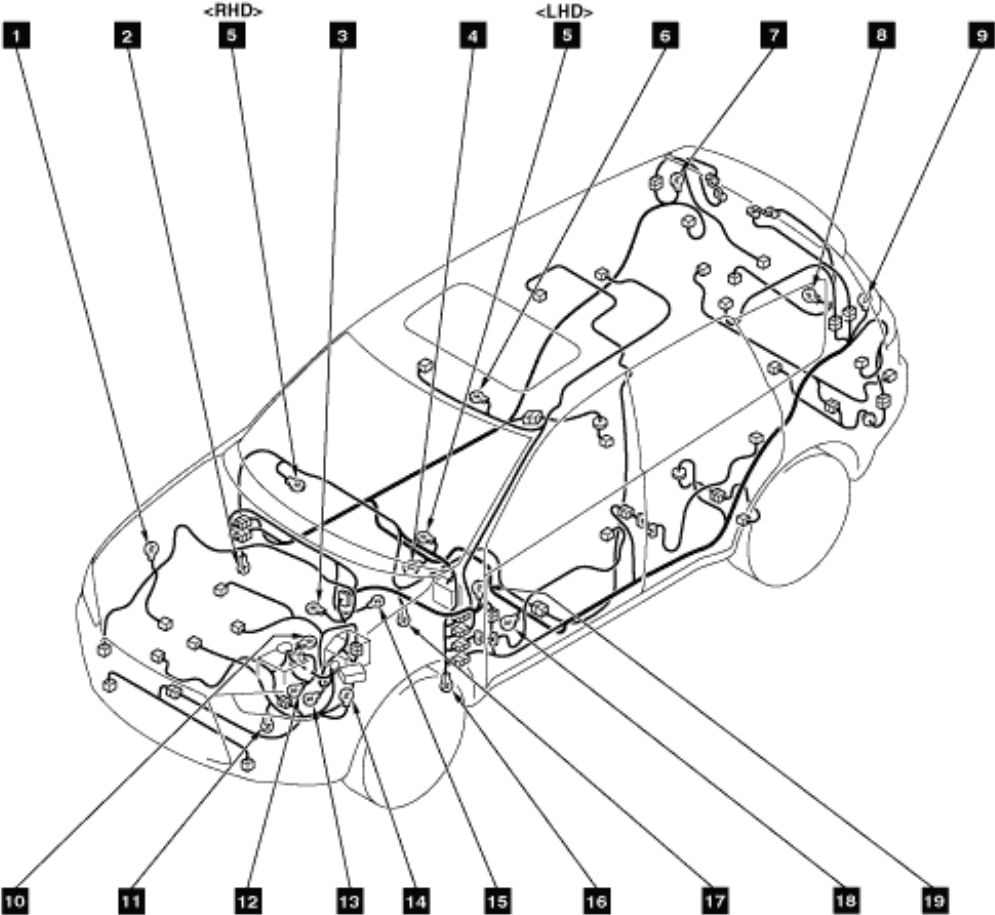

AC900154AC

<4B1>

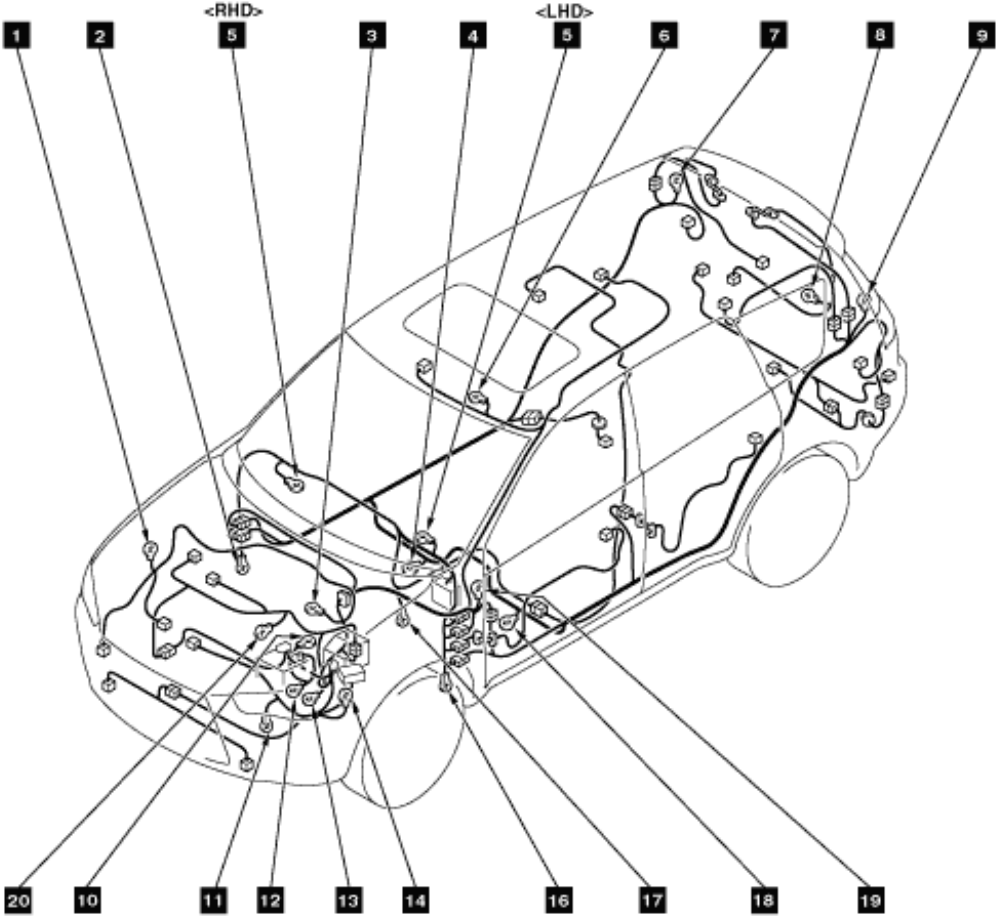

AC900248AE

<6B31>

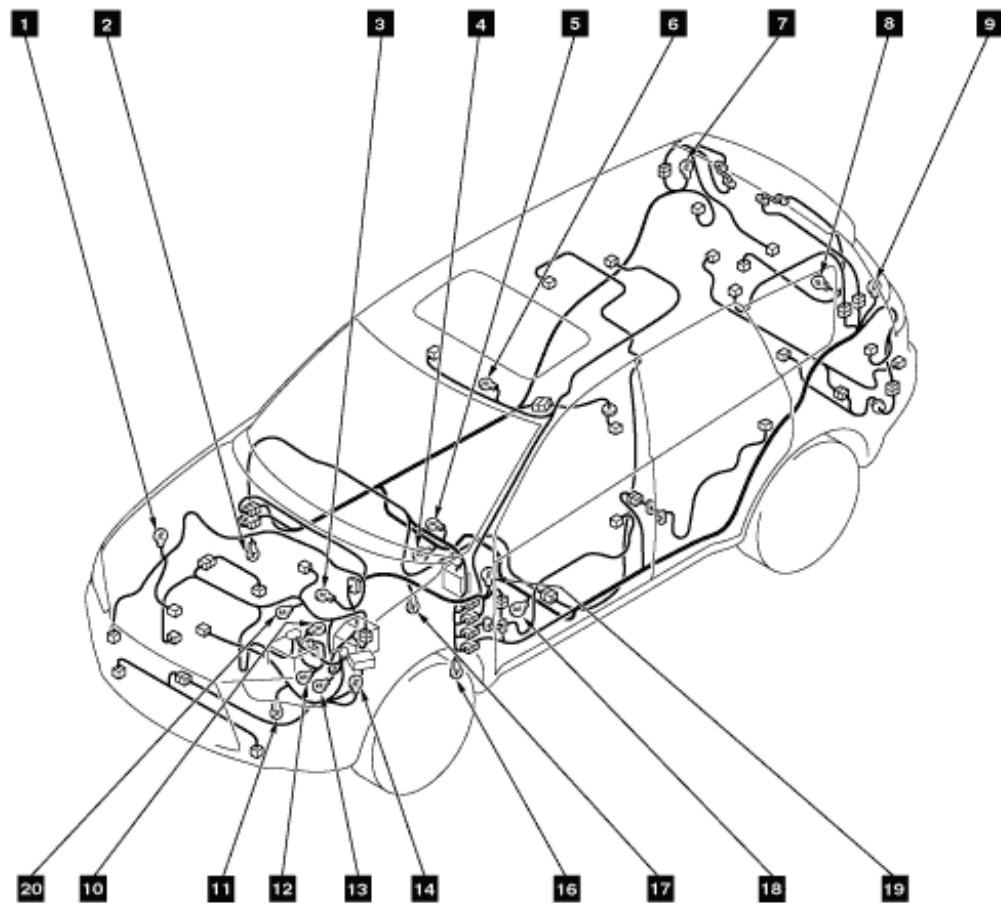

AC900249AC

note Same earth numbers are used in the circuit diagram.

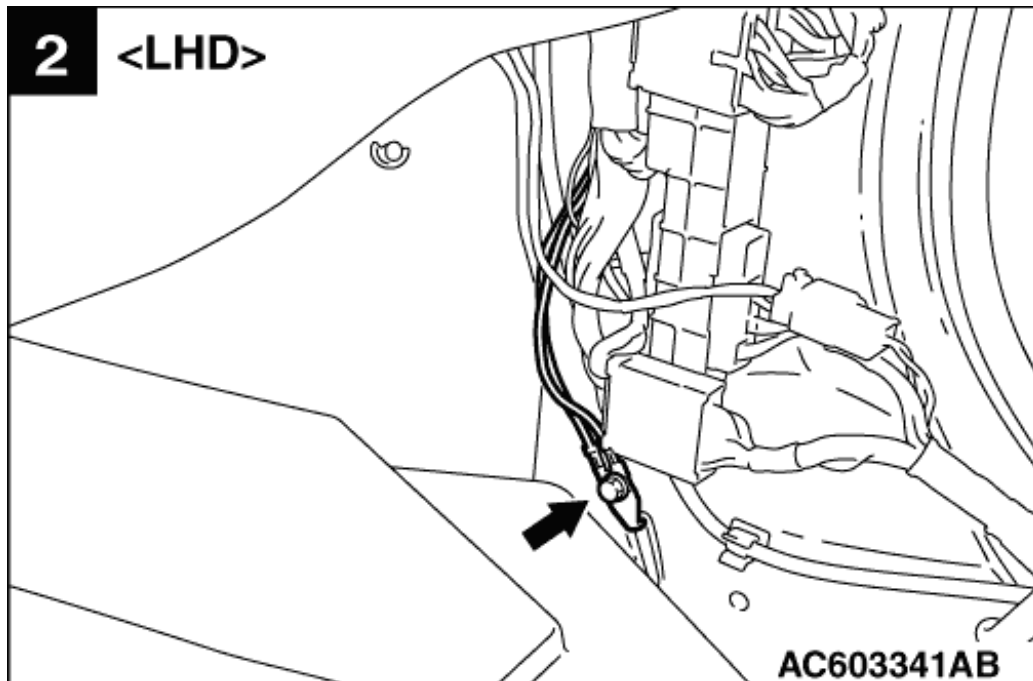
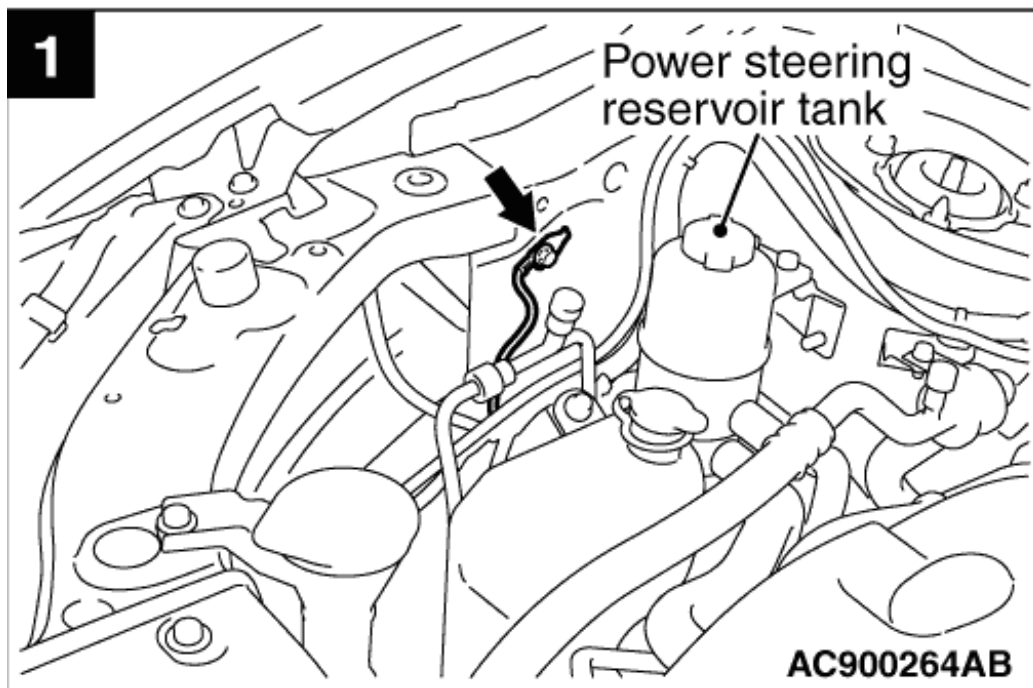

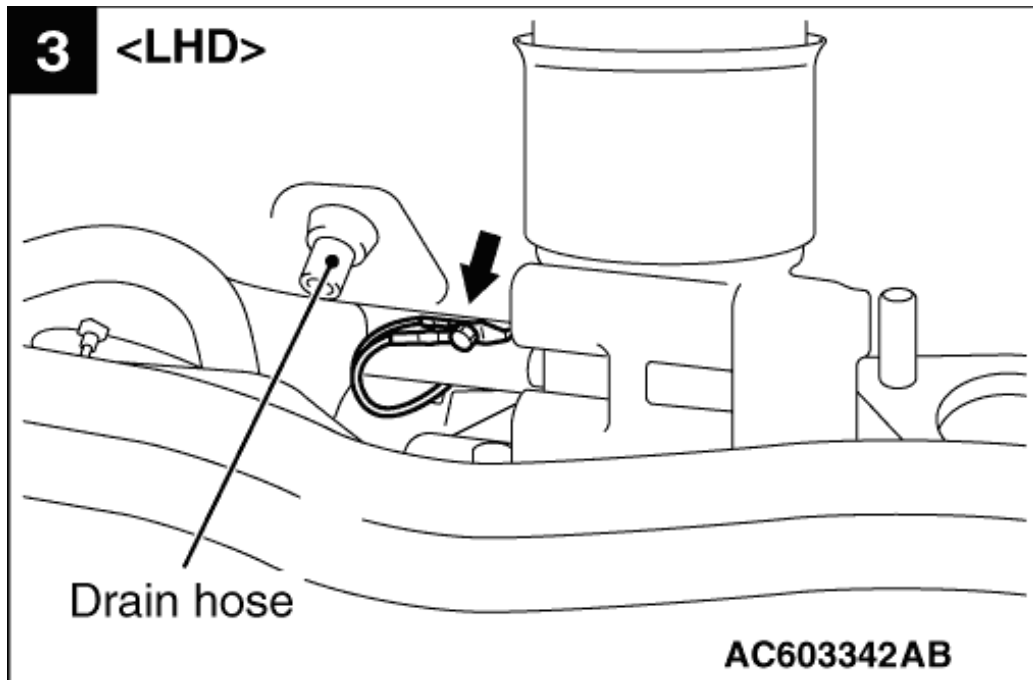
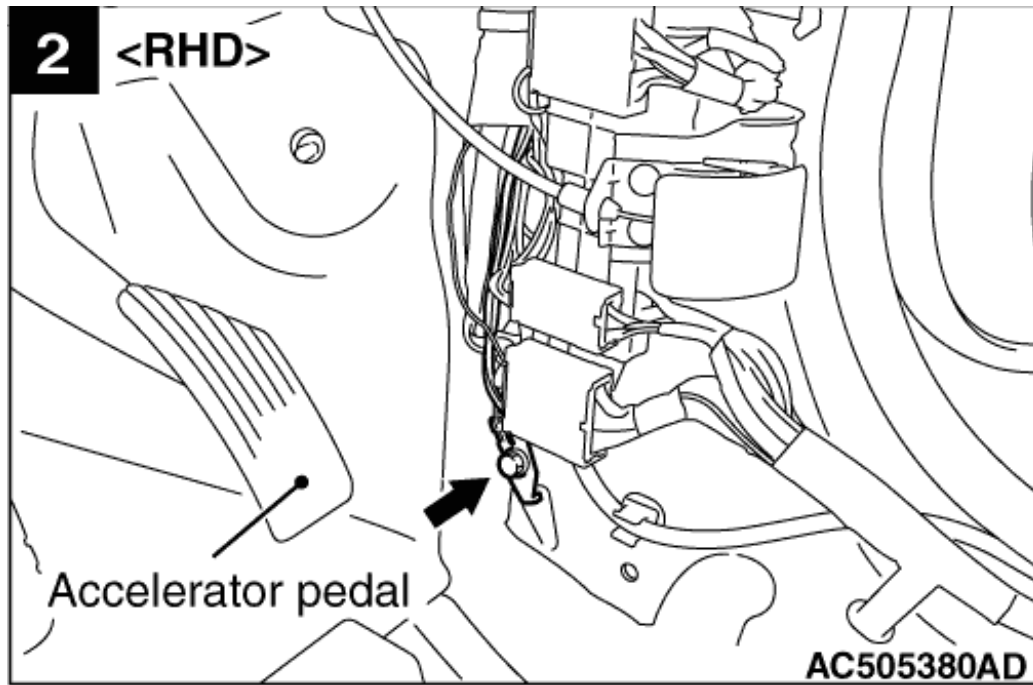

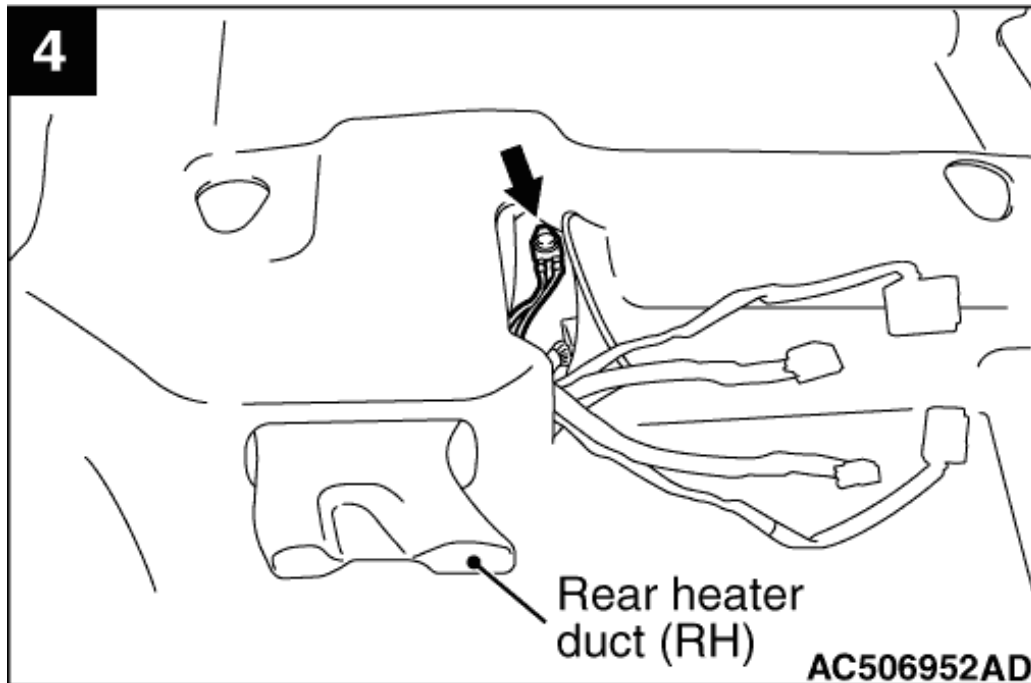
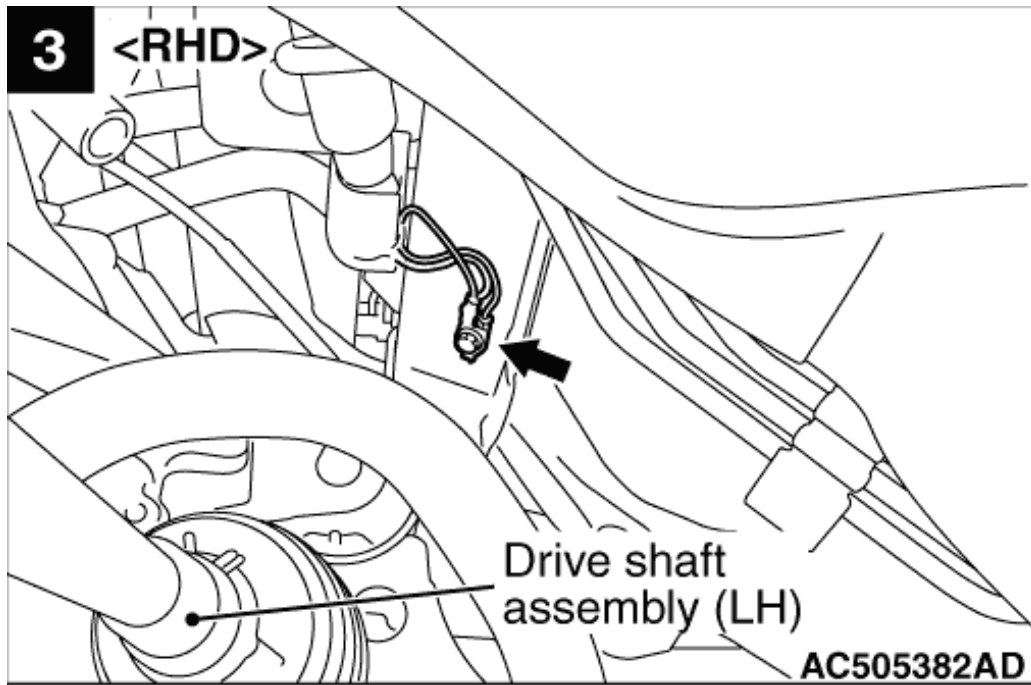

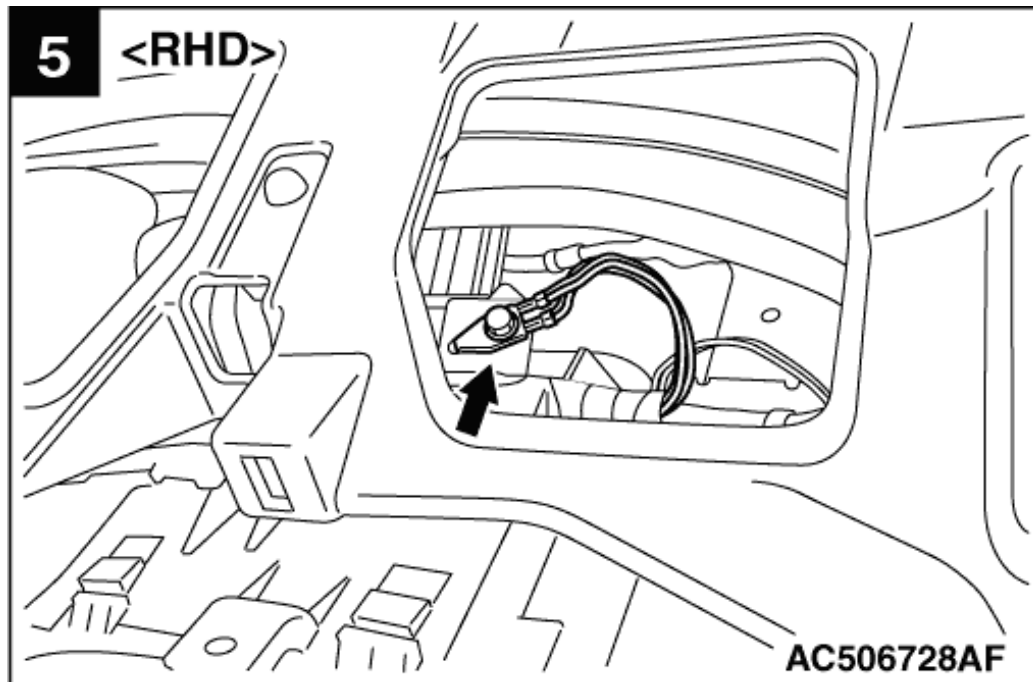

6

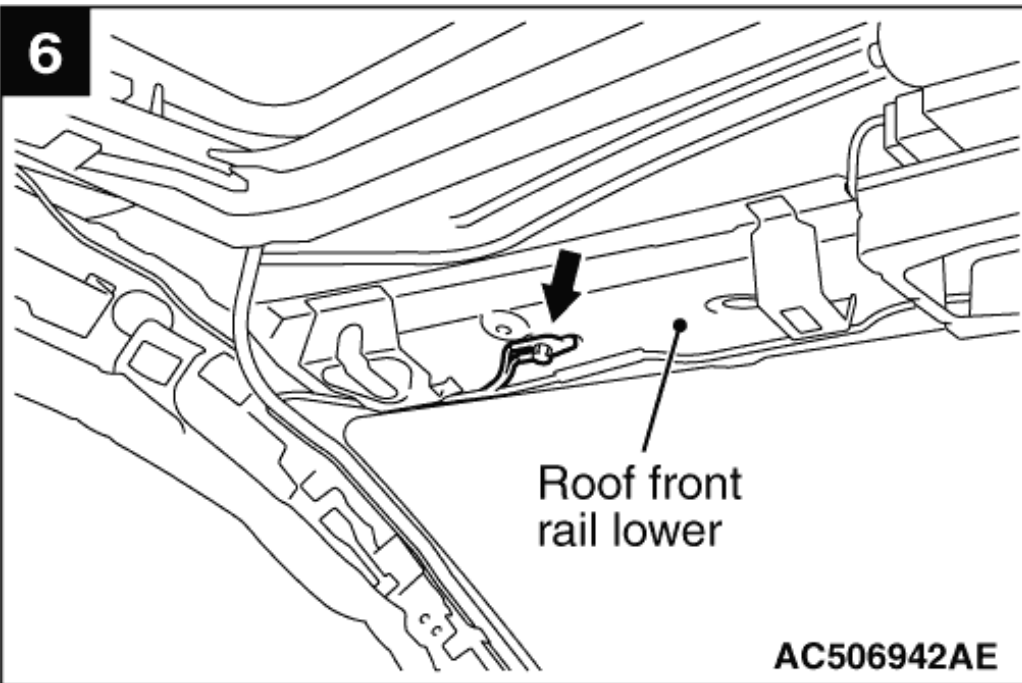

AC506942AE

7

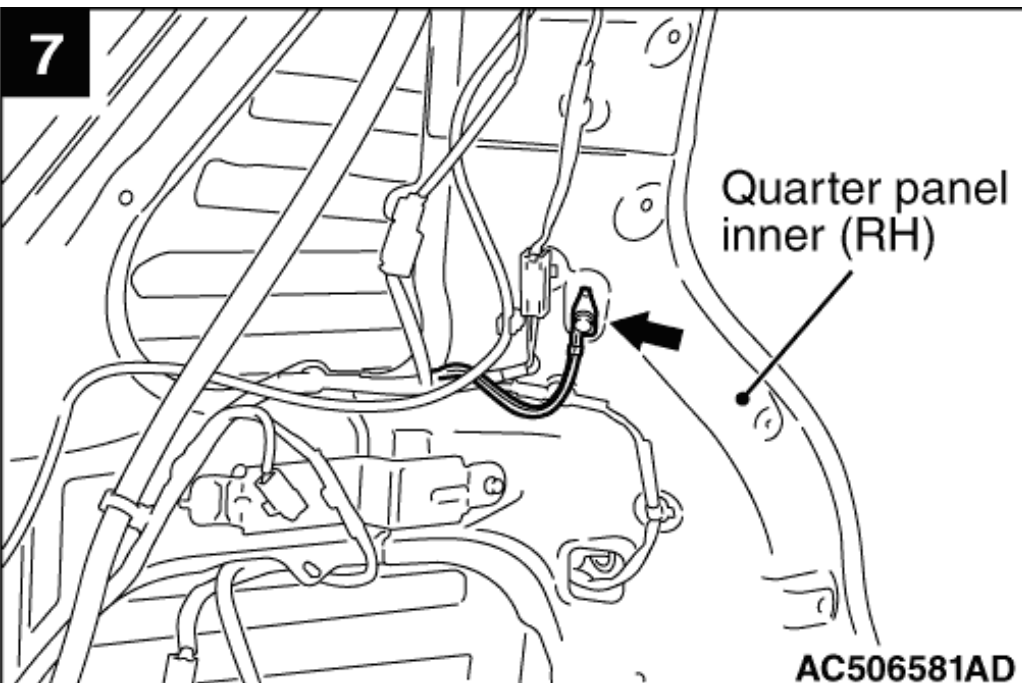

AC506581AD

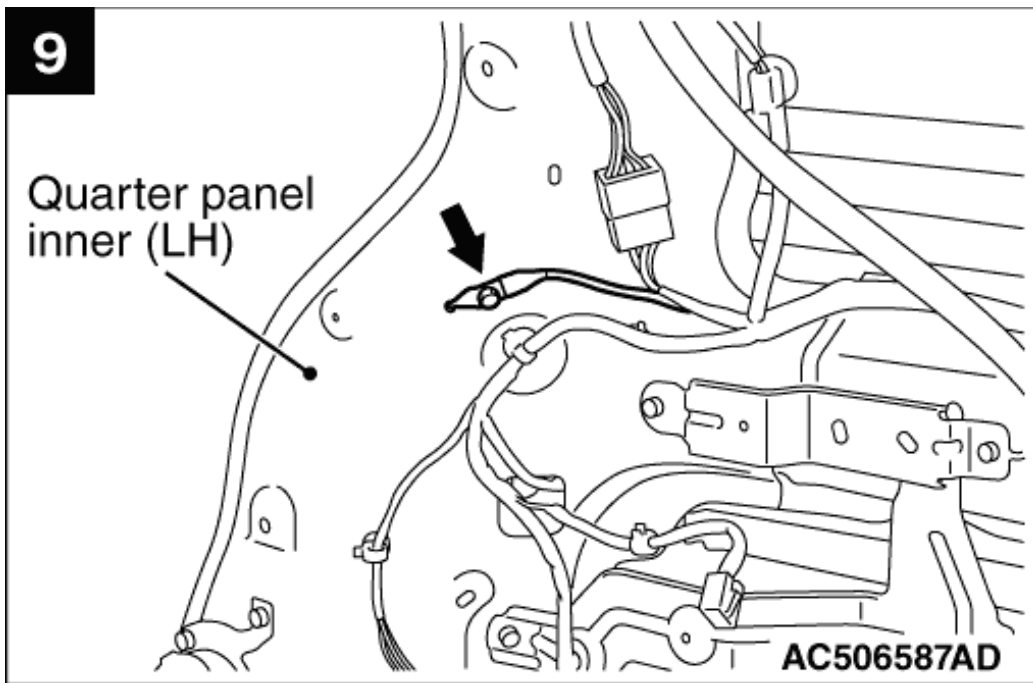
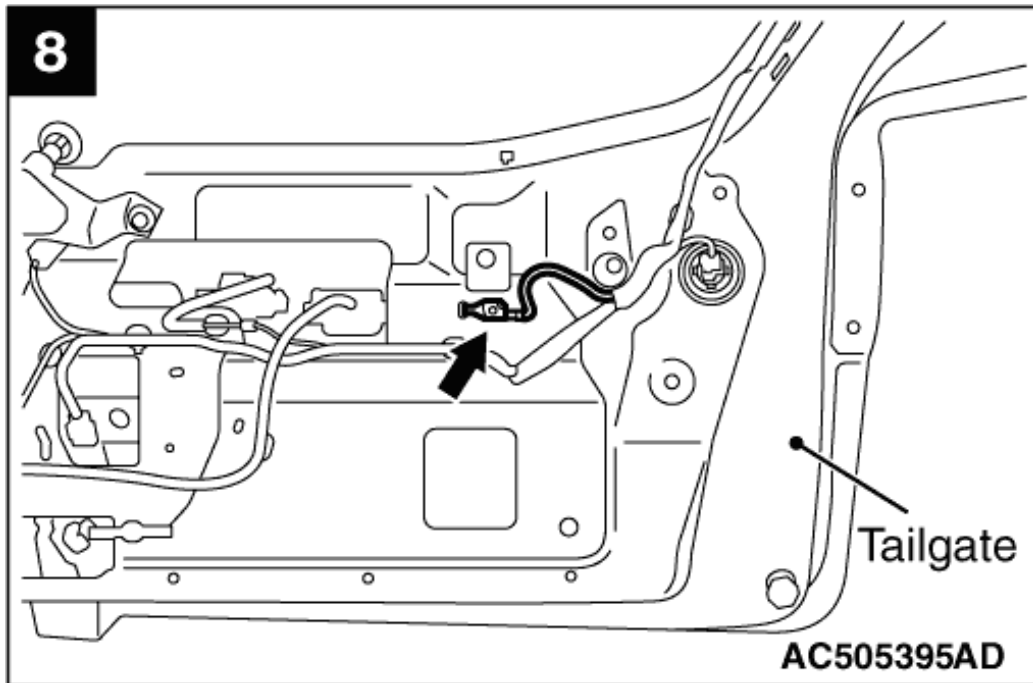

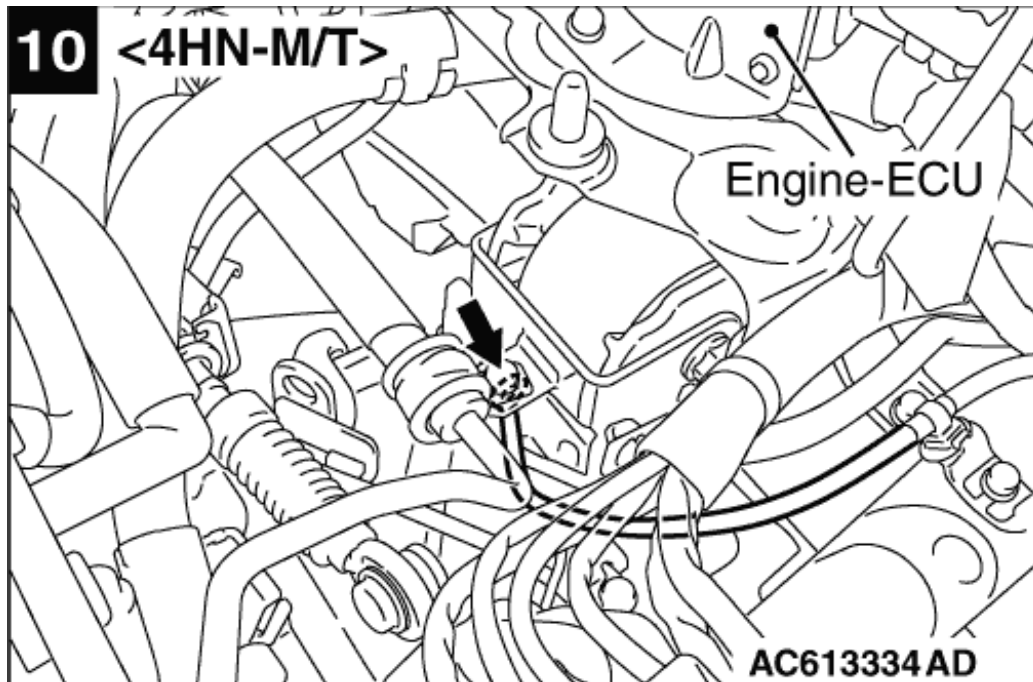
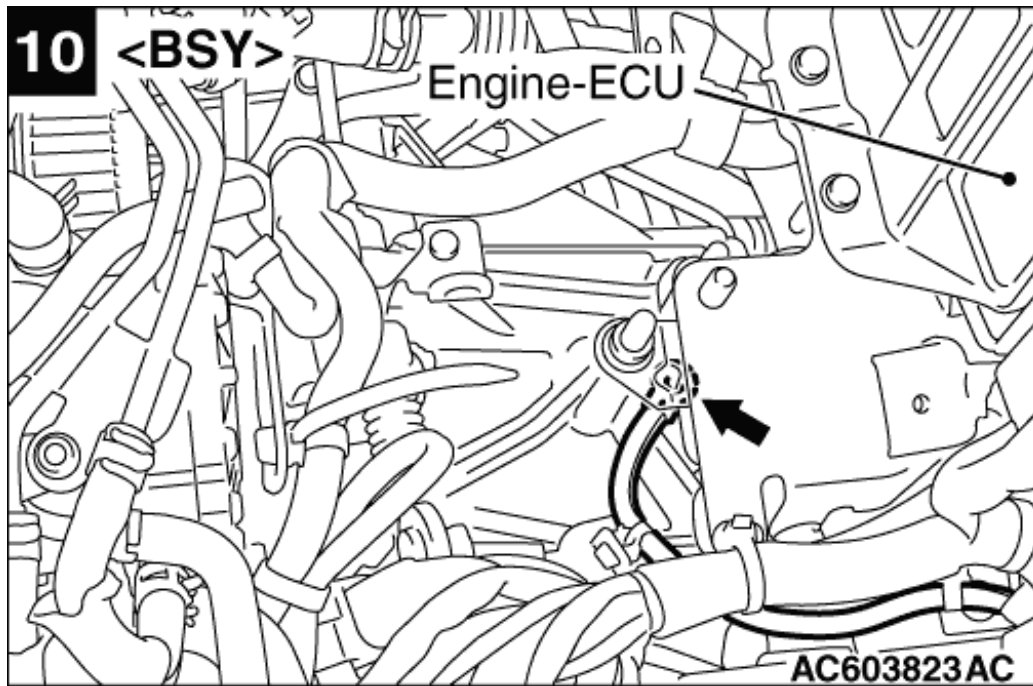

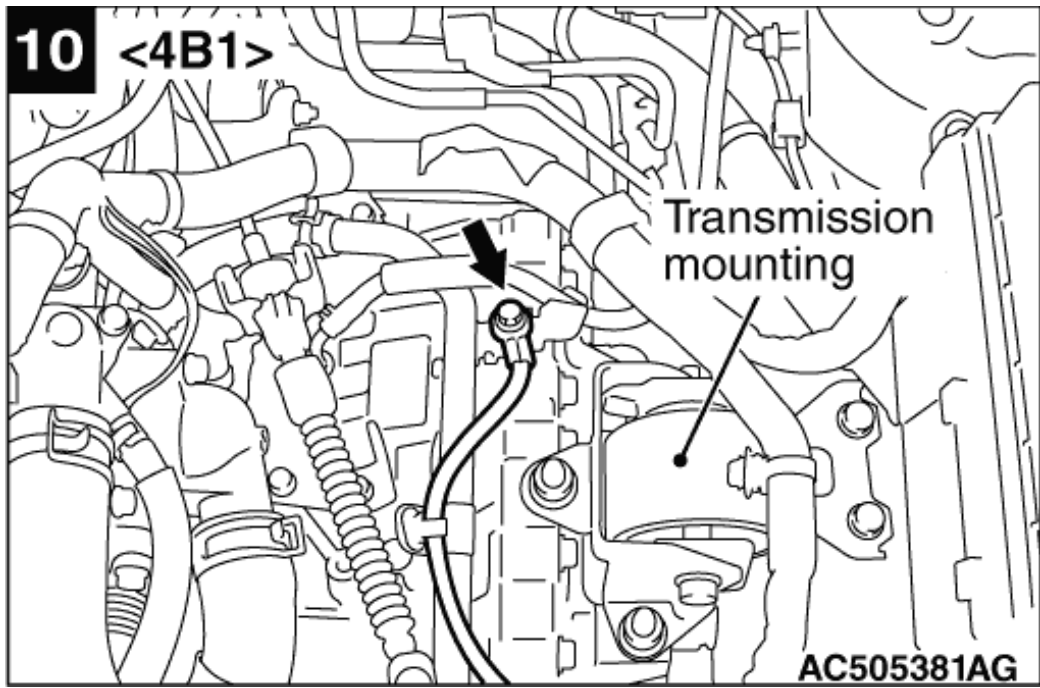
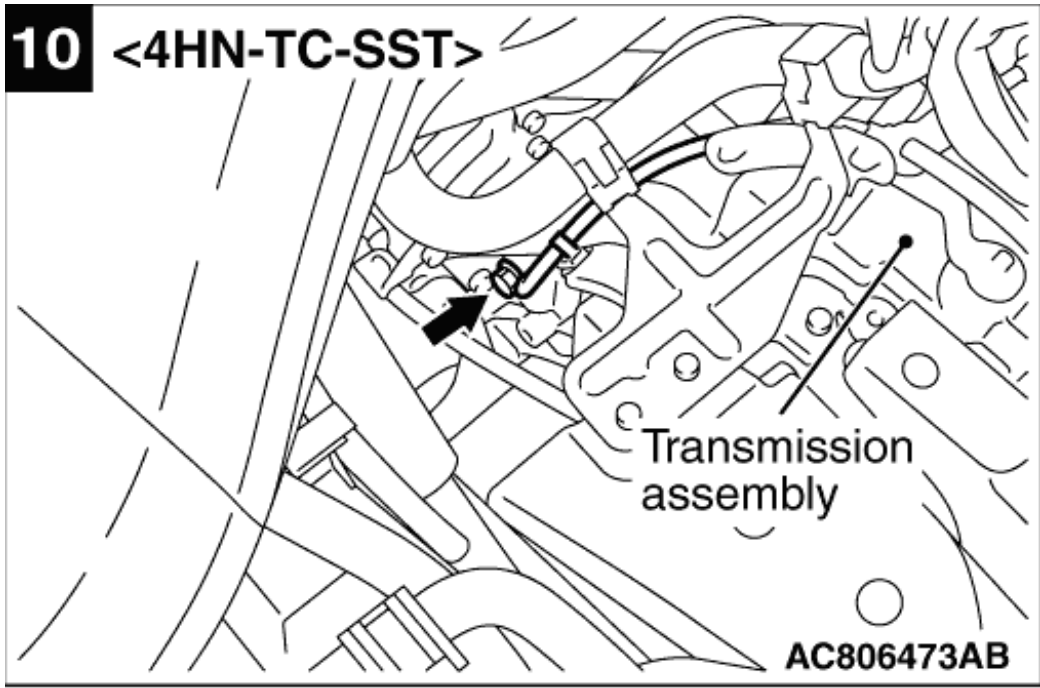

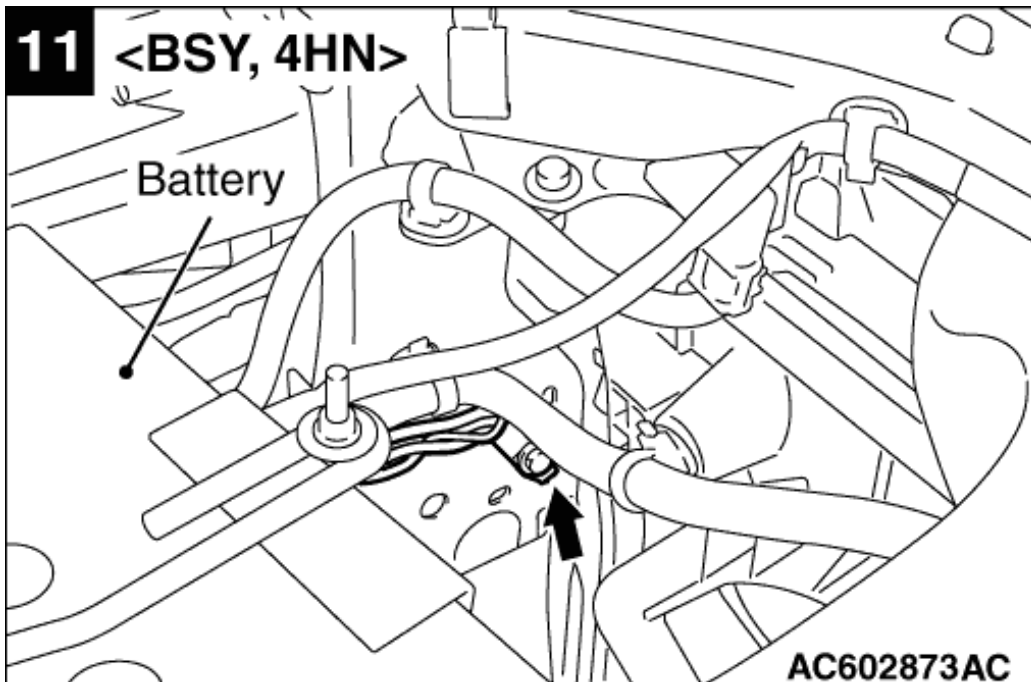
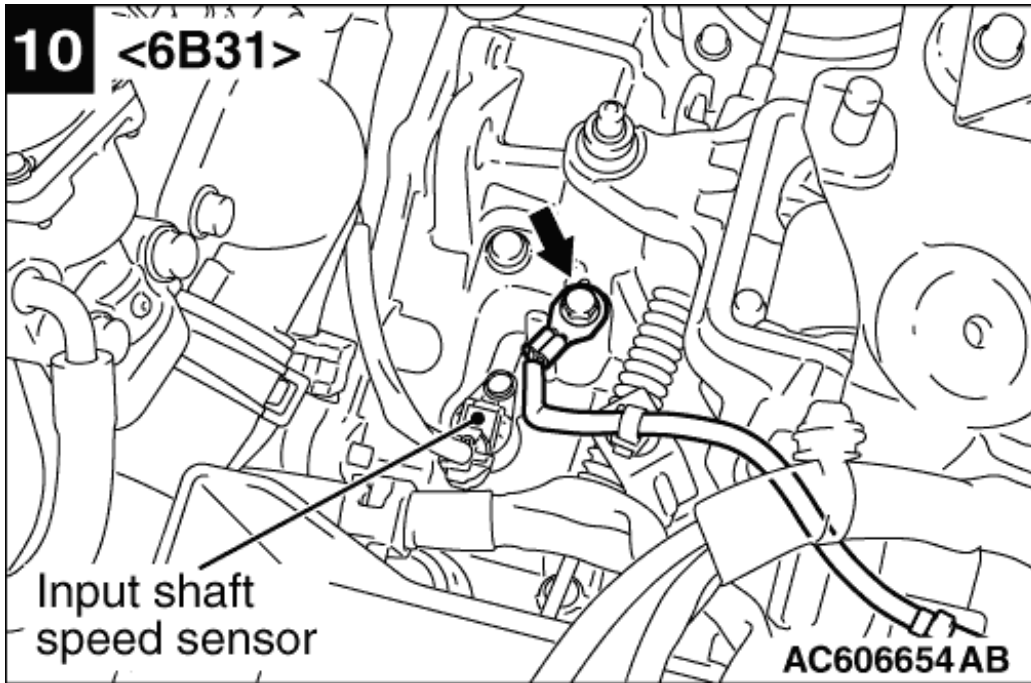

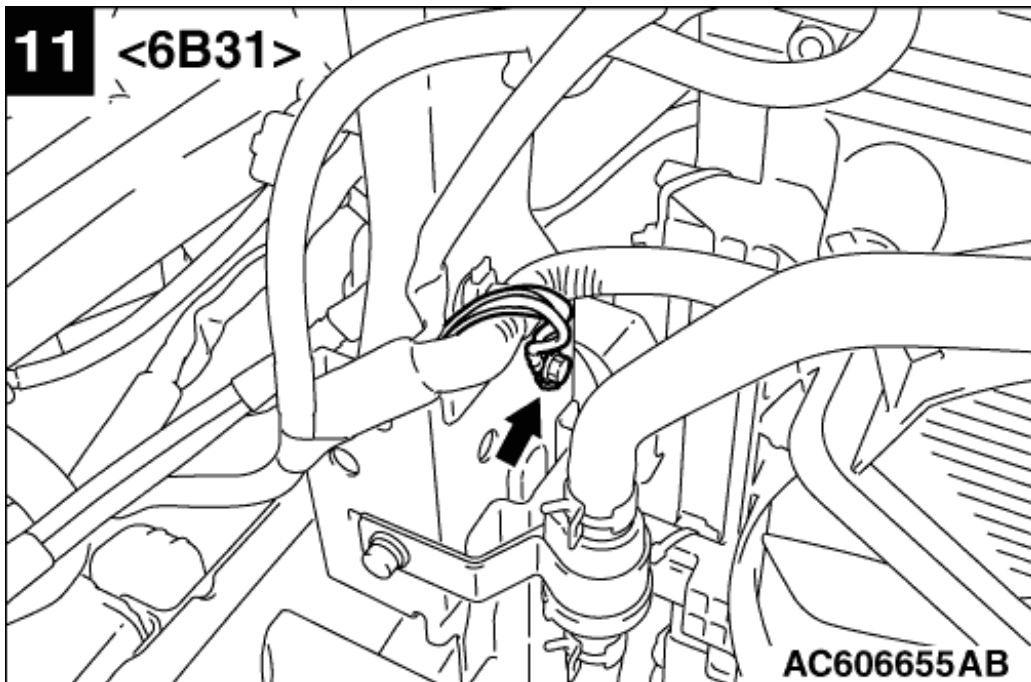
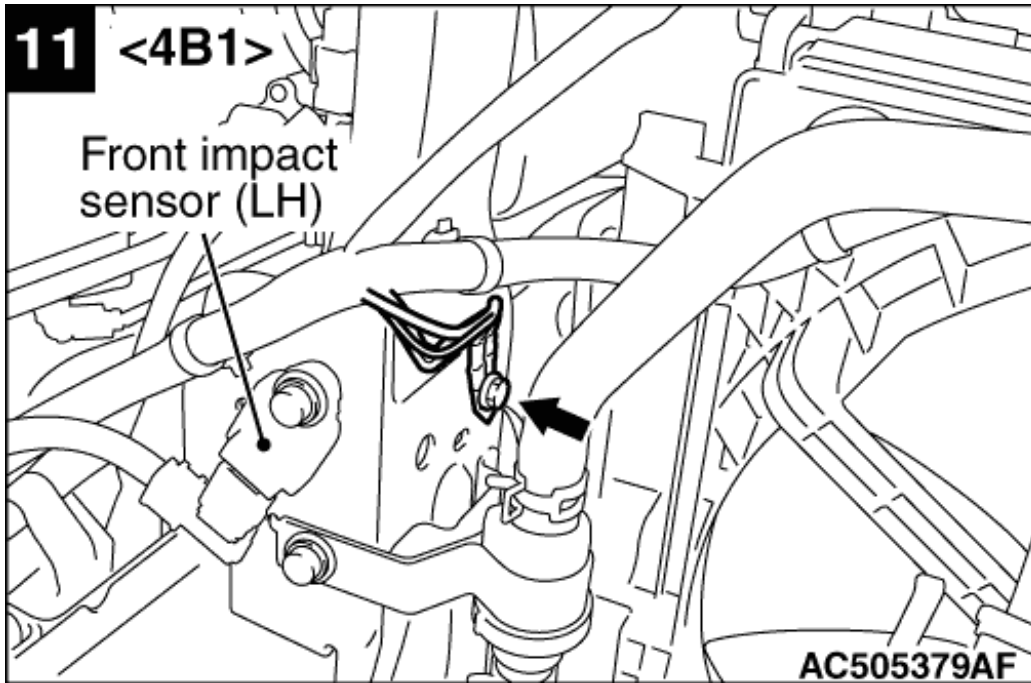

12,13

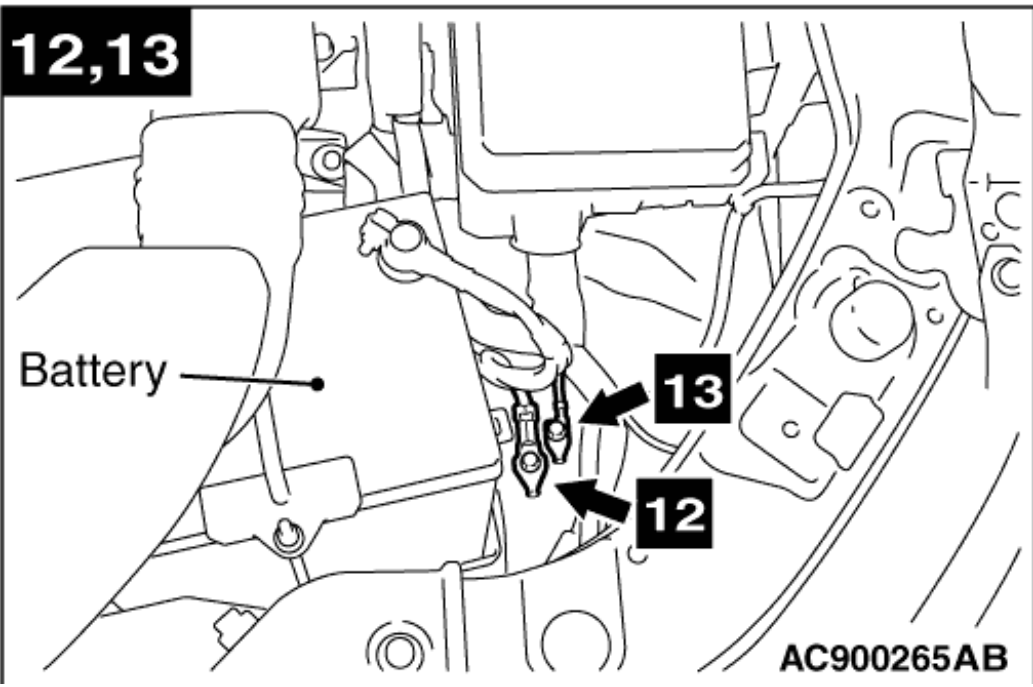

14

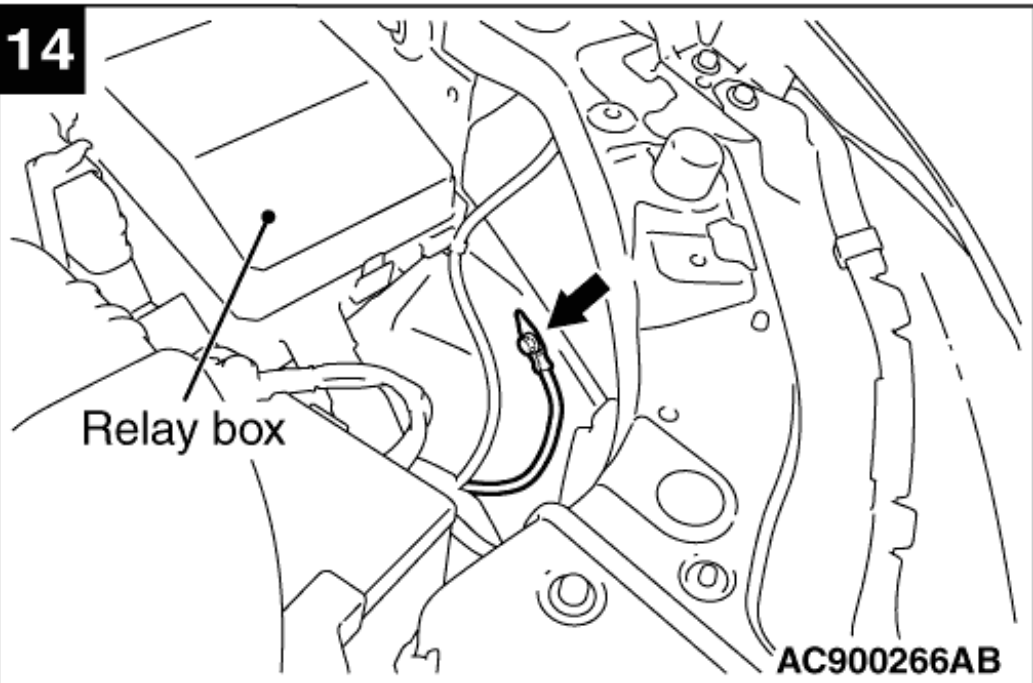

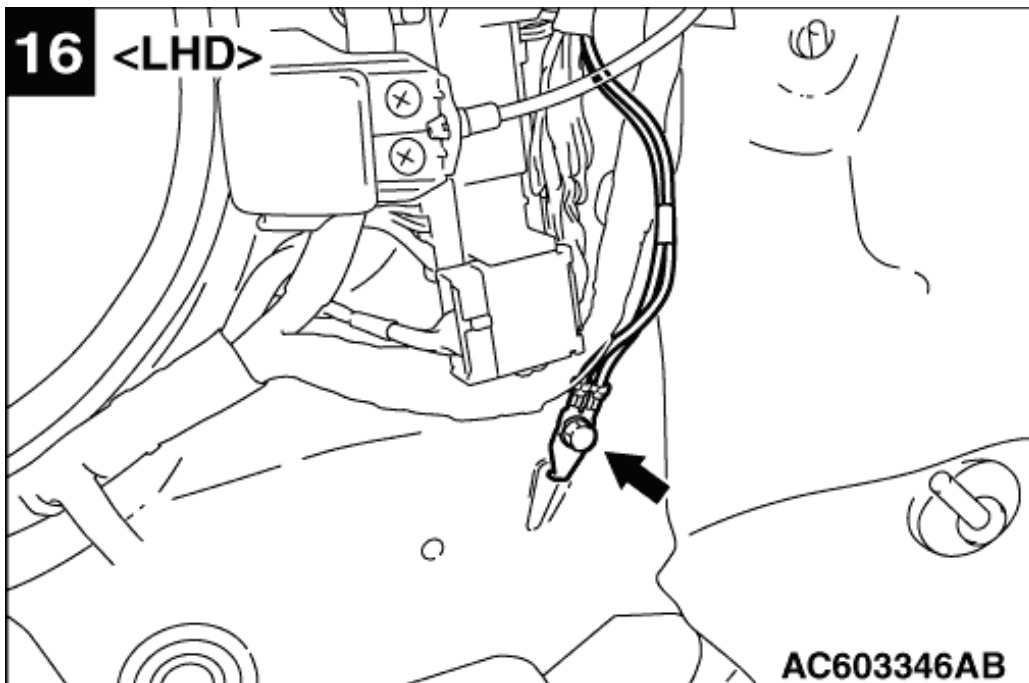
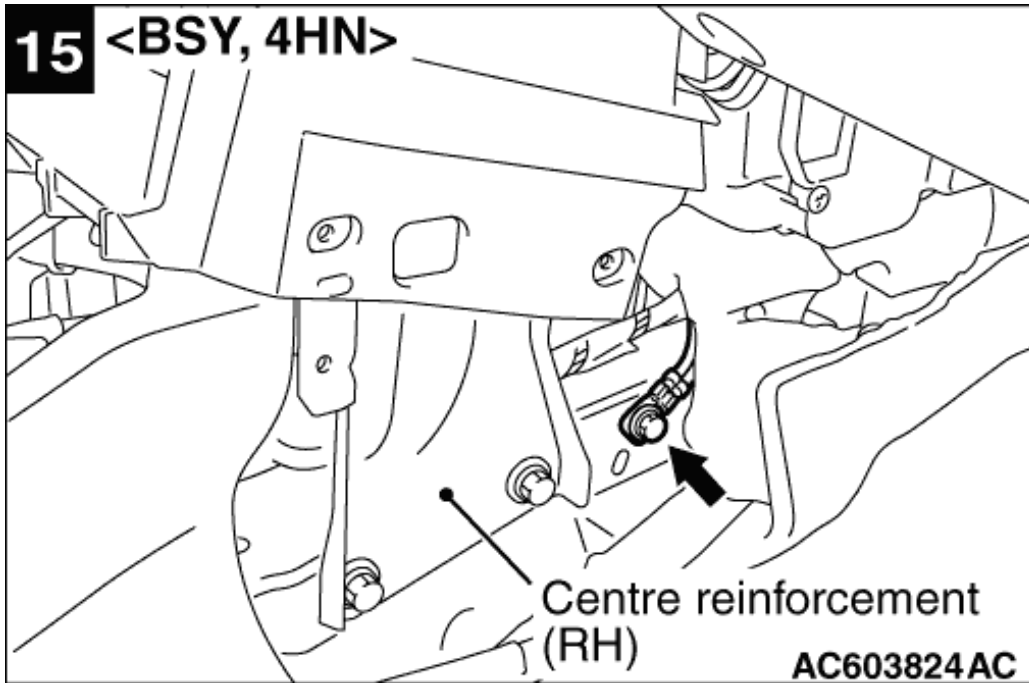

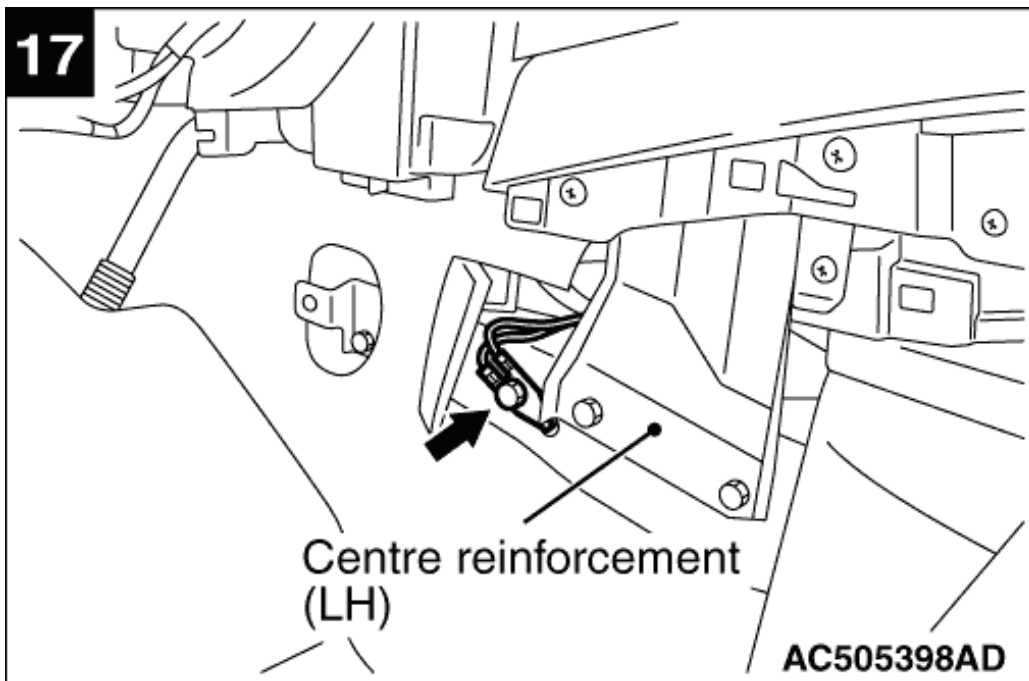
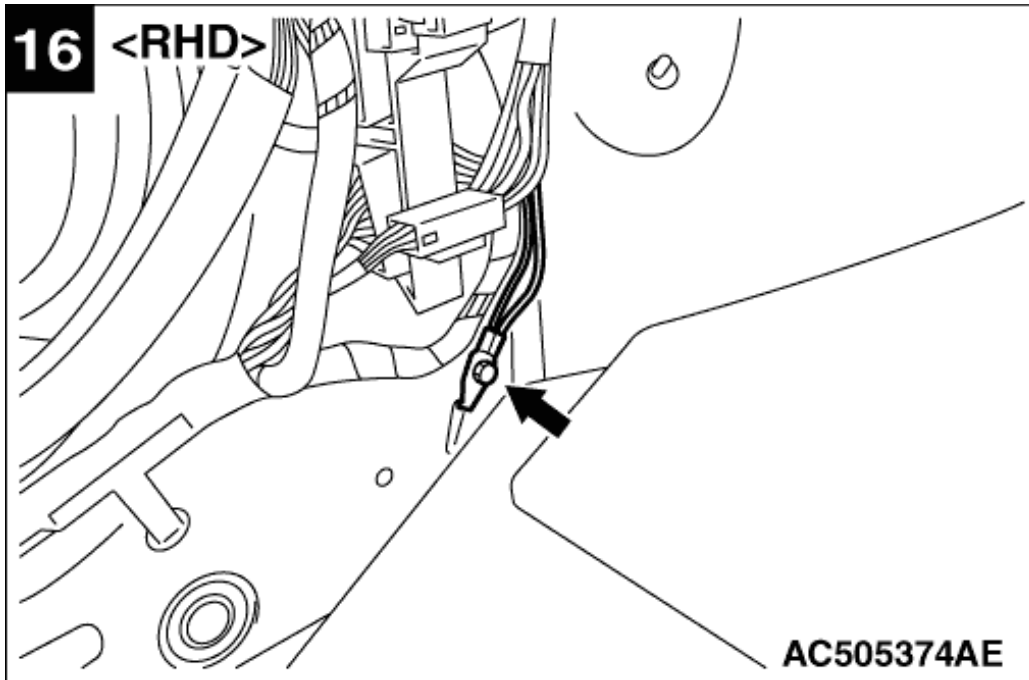

18

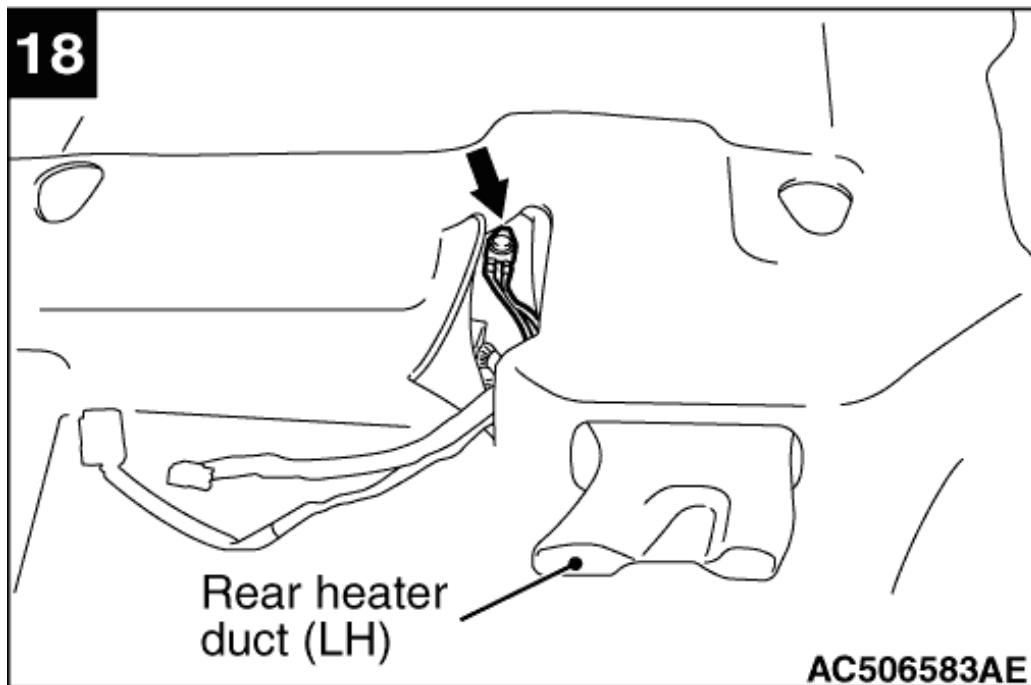

19 <LHD>

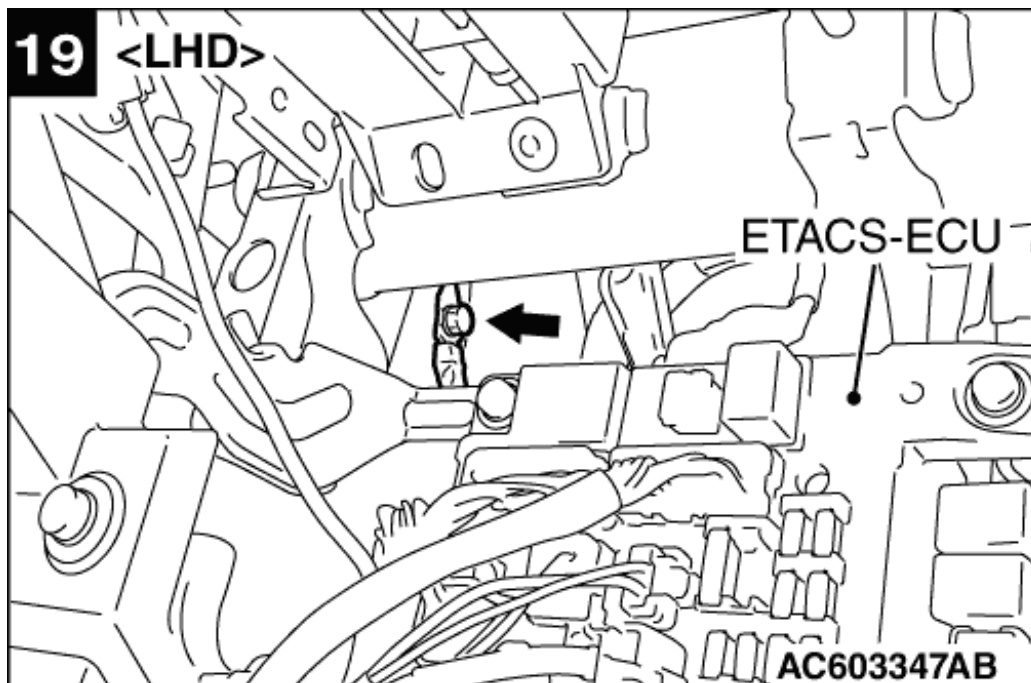

19 <RHD>

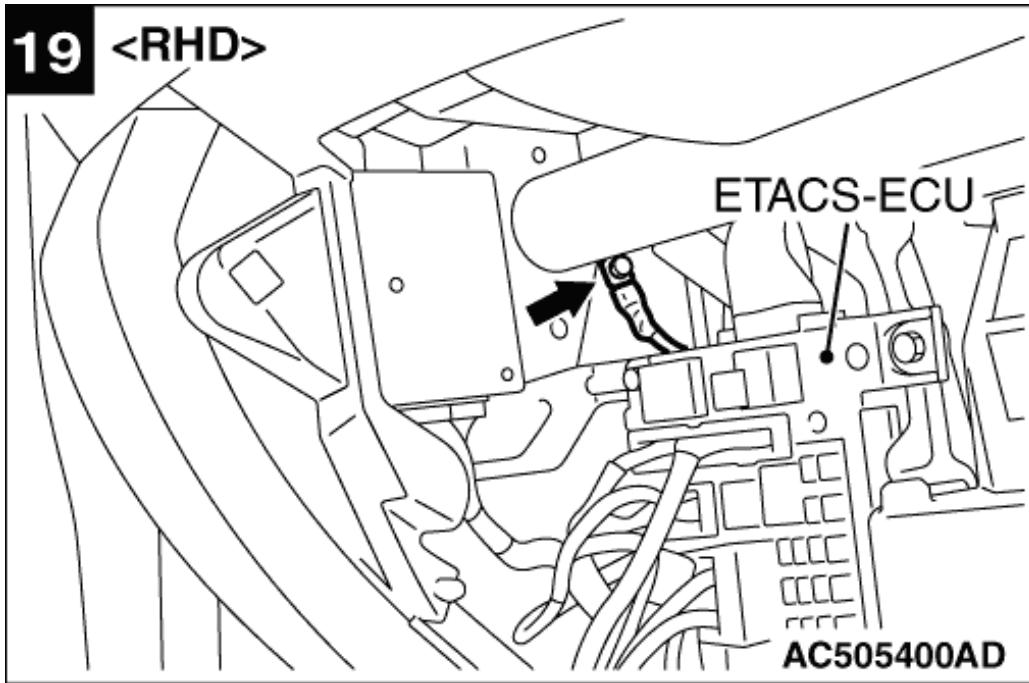

20 <4B1>

