

принцип

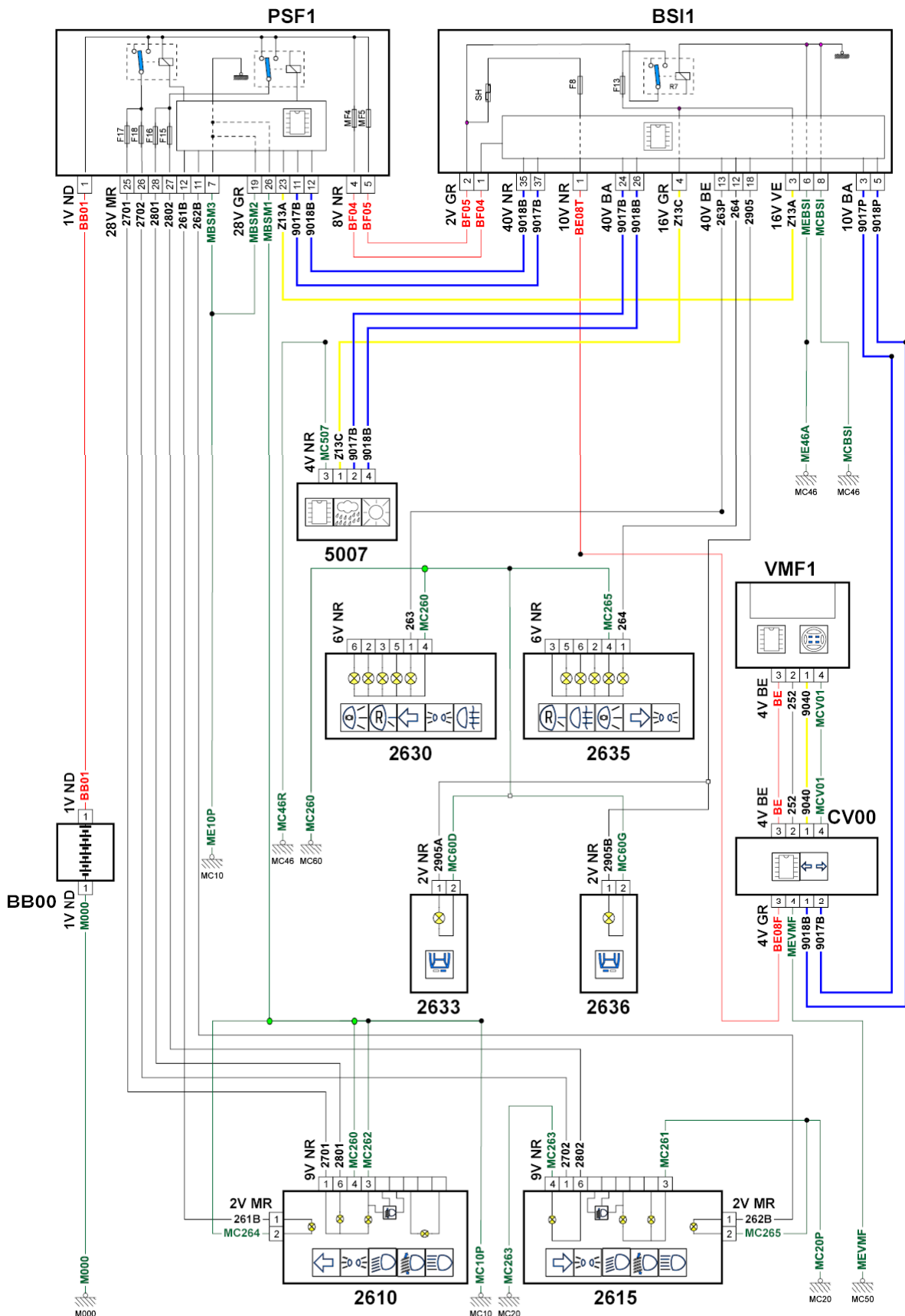

прокладка трубопроводов (кабелей, тросов)

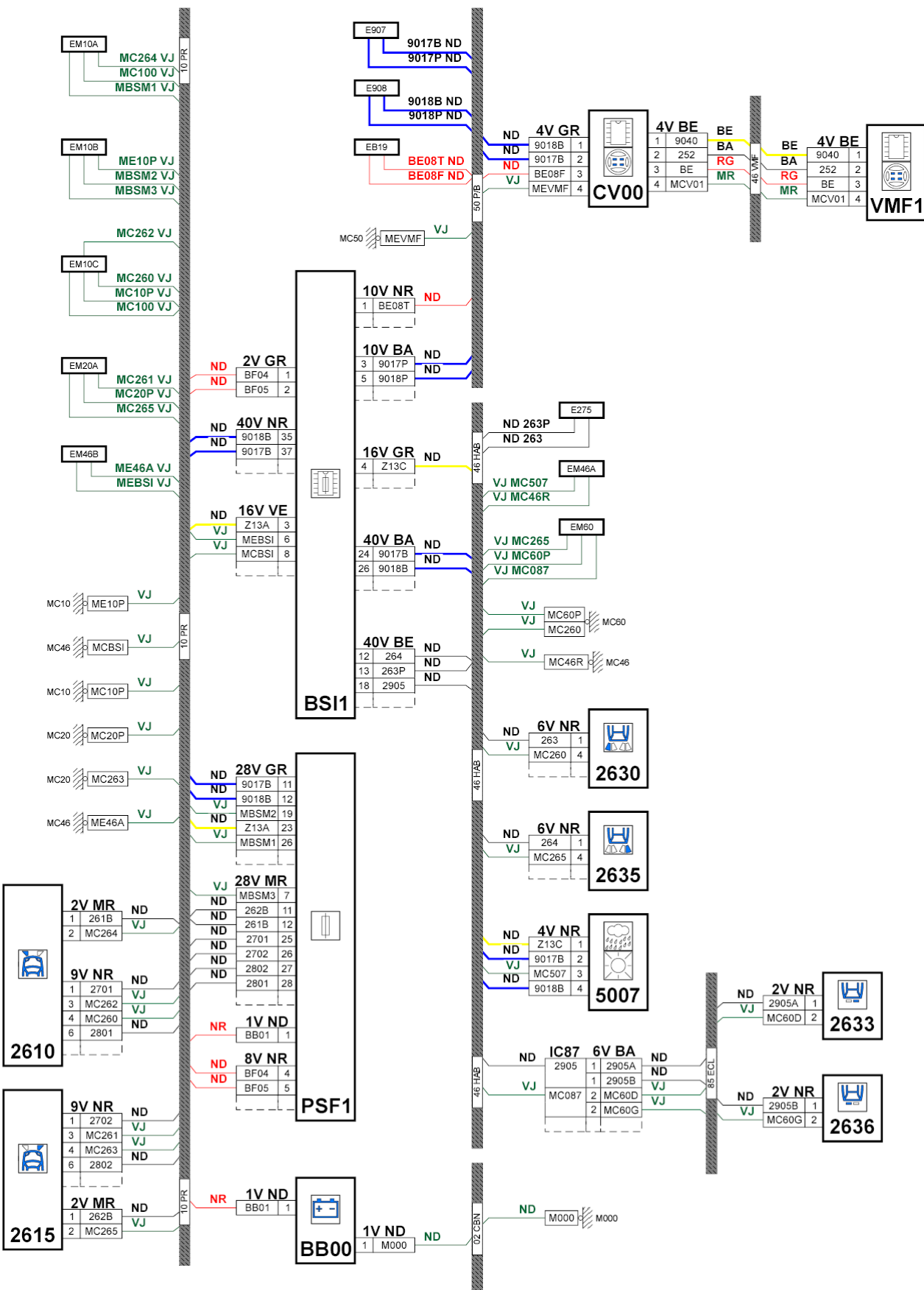

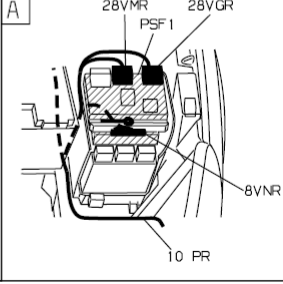
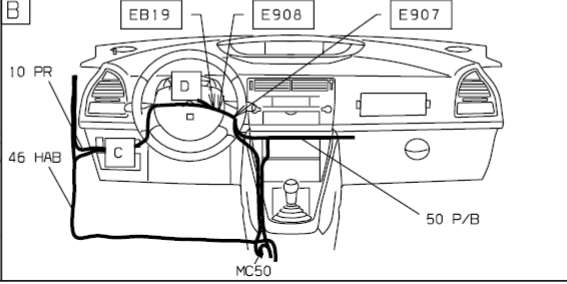
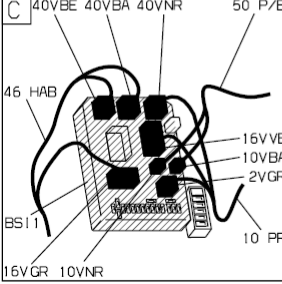
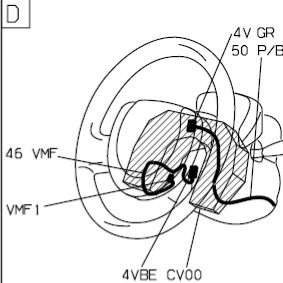
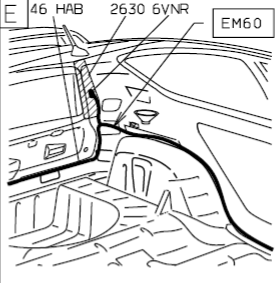
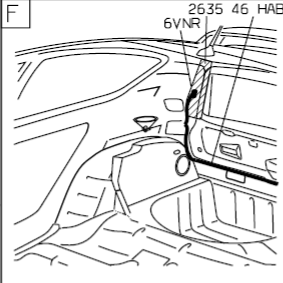
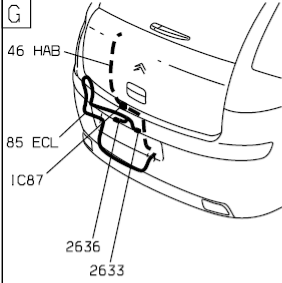
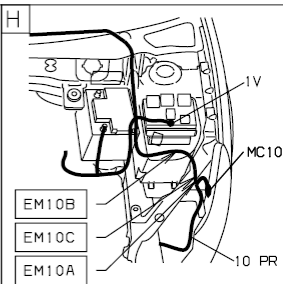
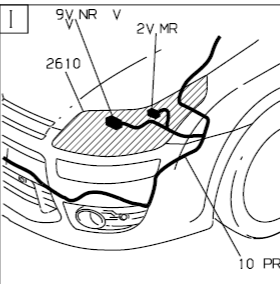
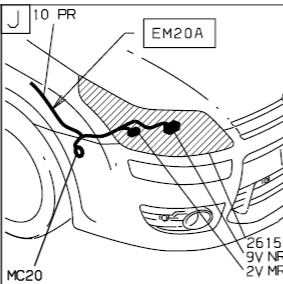
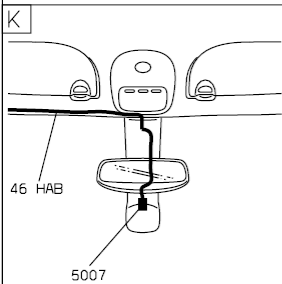
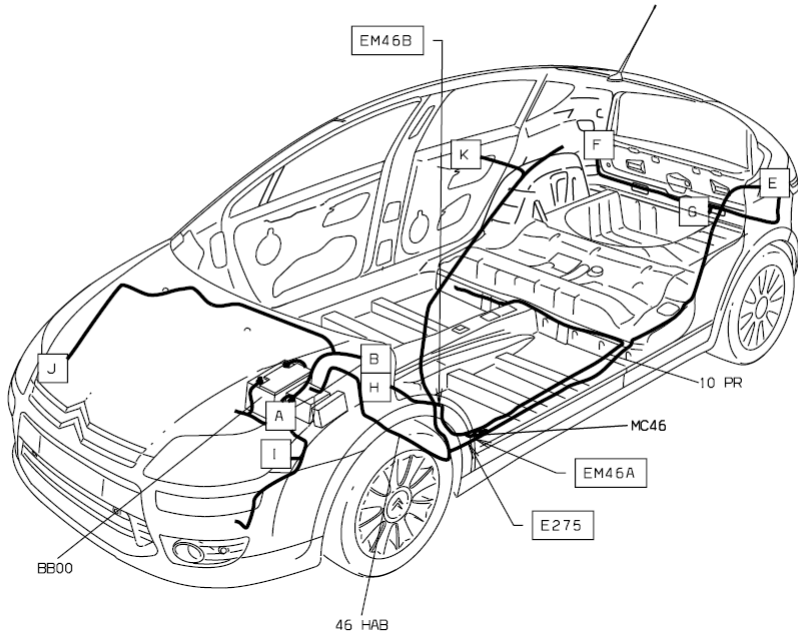

D3ARS4K I