

принцип BS11

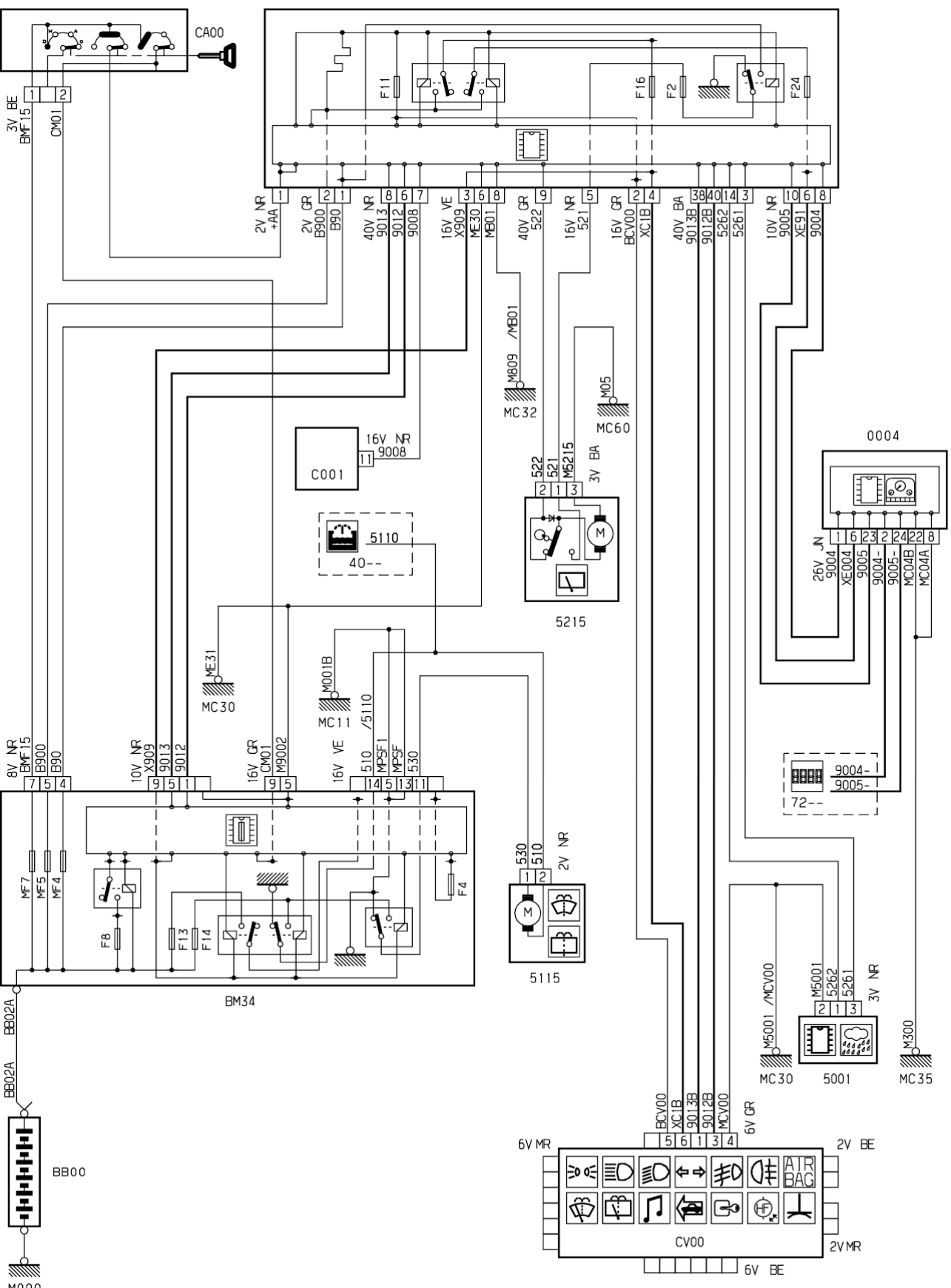

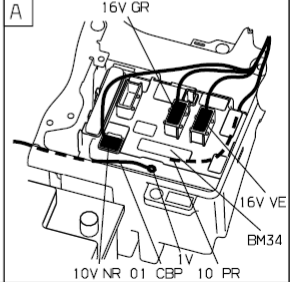

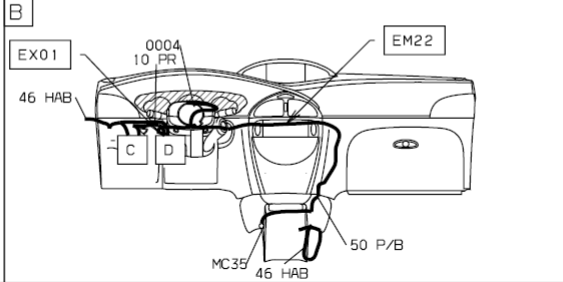
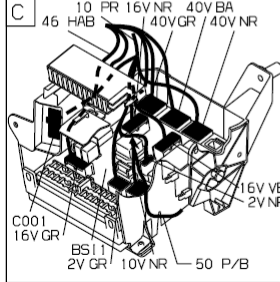
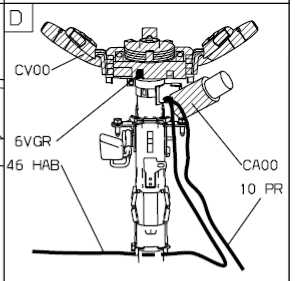
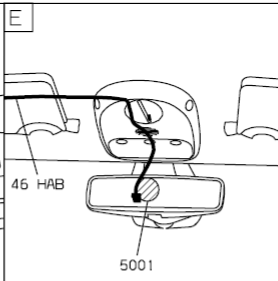
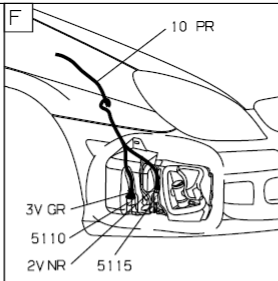
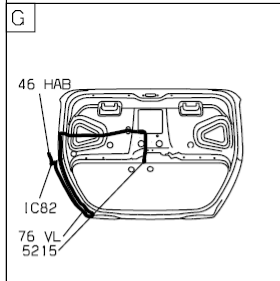
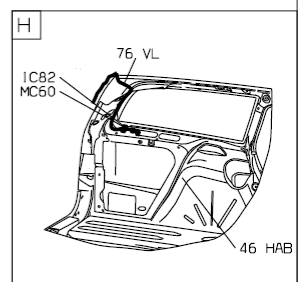
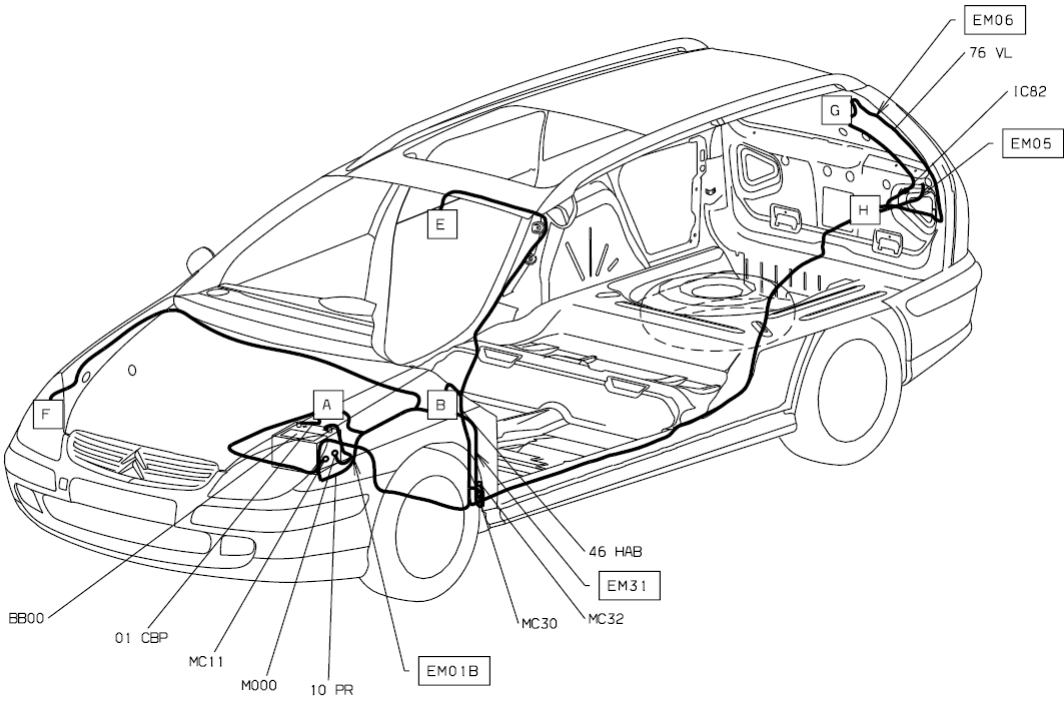

D3AR7181