



ACT: 1864

Réf.: 9690.01

# Aide aux stationnements avant



## C4(B71)

FR NOTICE DE POSE A USAGE PROFESSIONNEL / PHOTOS ET DESSINS NON CONTRACTUELS  
GB FITTING INSTRUCTIONS FOR PROFESSIONAL FITTERS / PICTURES AND DRAWINGS  
ES INSTRUCCIONES DE MONTAJE PARA USO PROFESIONAL / FOTOS Y DIBUJOS SIN  
P MANUAL DE MONTAGEM PARA UTILIZAÇÃO PROFISSIONAL / FOTOGRAFIAS E DESENHOS  
DE MONTAGEANLEITUNG FÜR PROFESSIONNELLEN EINSATZ / NICHT VERTRAGSMÄSSIGE  
IT ISTRUZIONI DI POSA AD USO PROFESSIONALE / FOTO E DISEGNI NON CONTRATTUALI  
NL MONTAGEHANDLEIDING VOOR PROFESSIONEEL GEBRUIK / FOTO'S EN TEKENINGEN

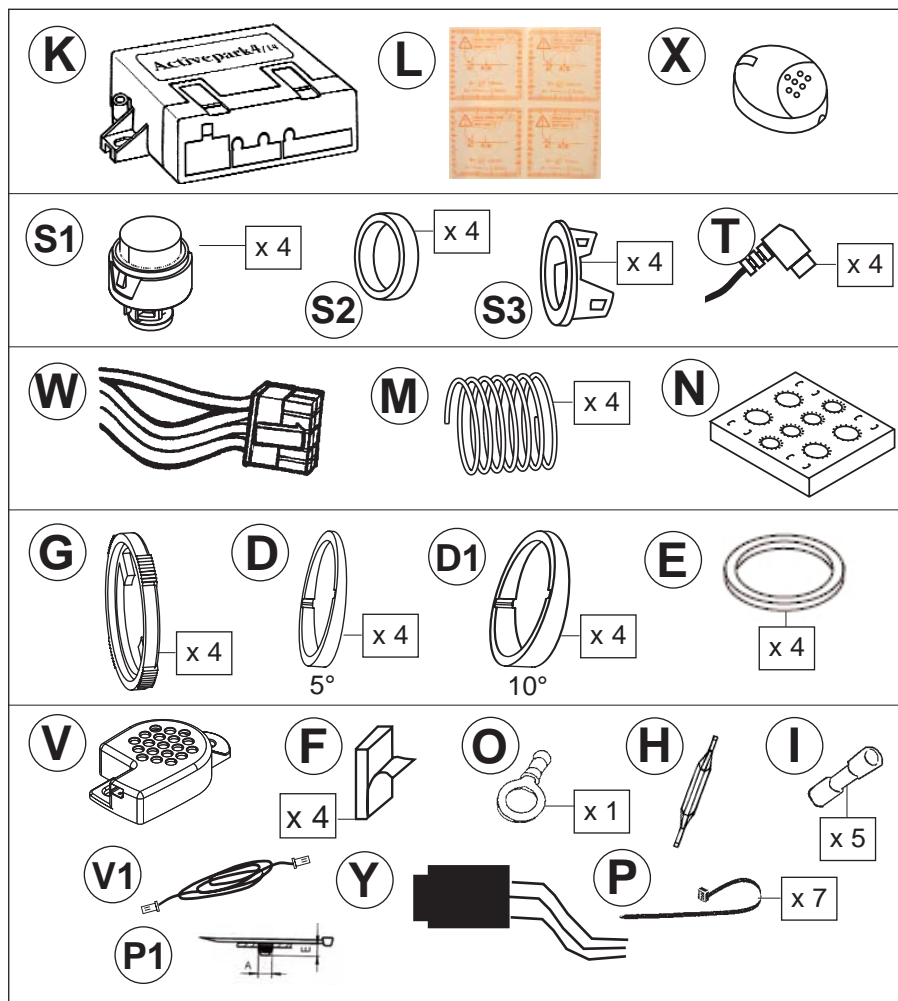

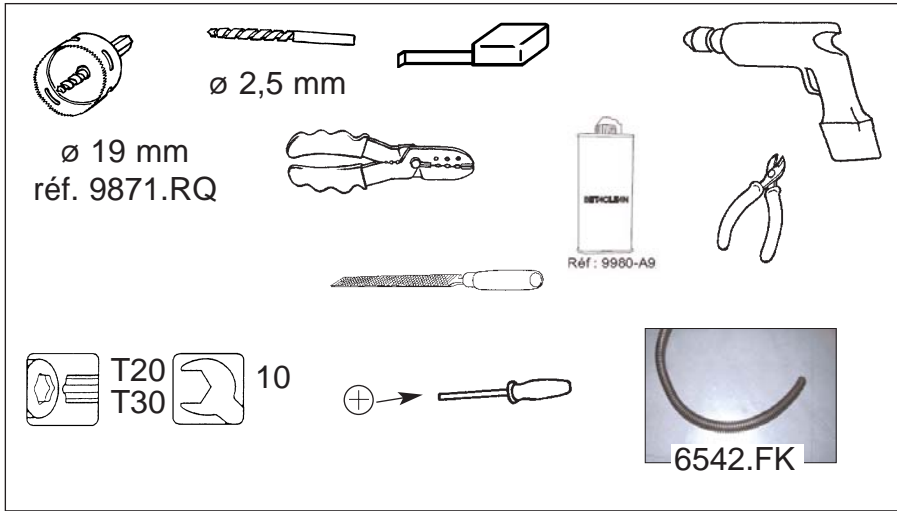

1

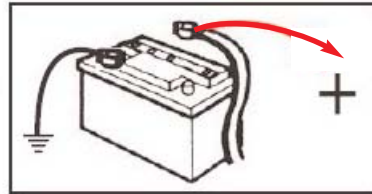

2

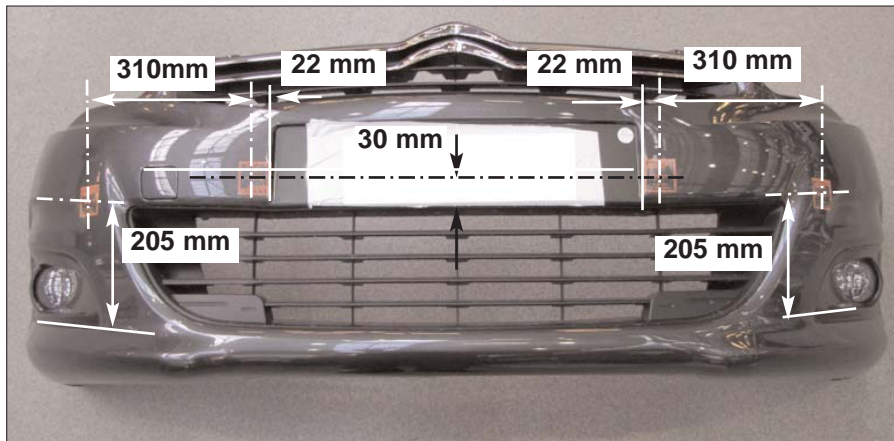

3

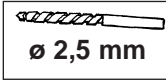
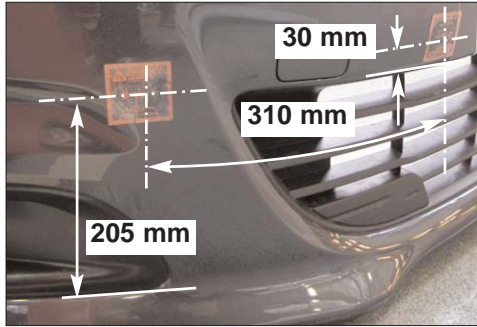

L

4x

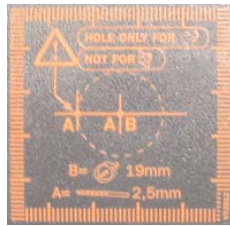
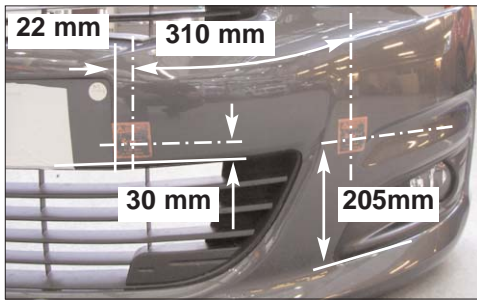

4

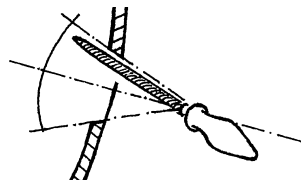
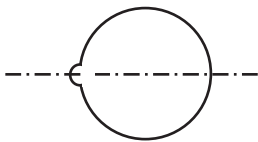

5

S

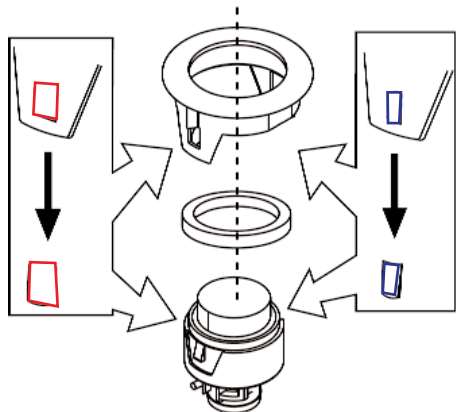

4x

6

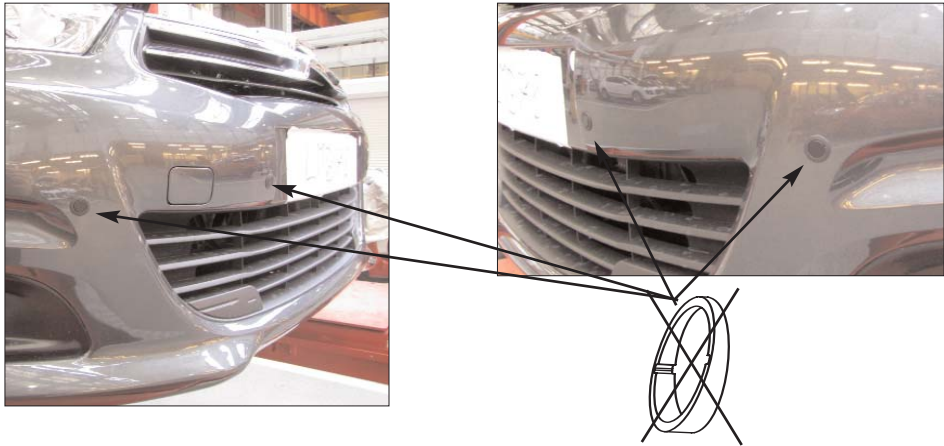
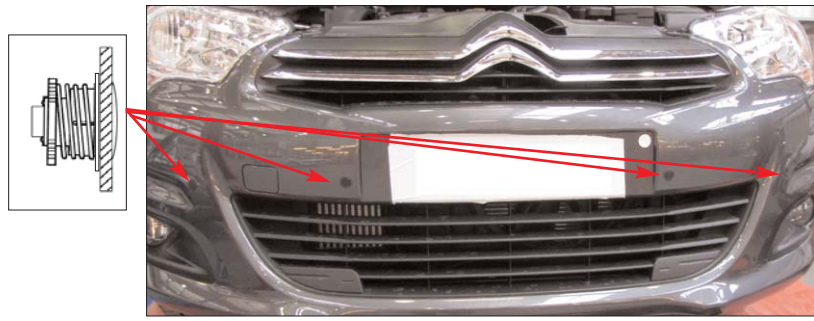

7



8



9

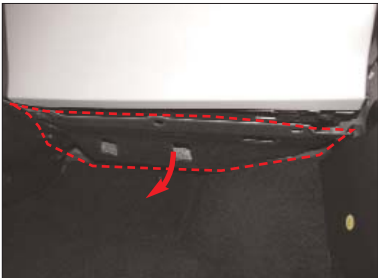
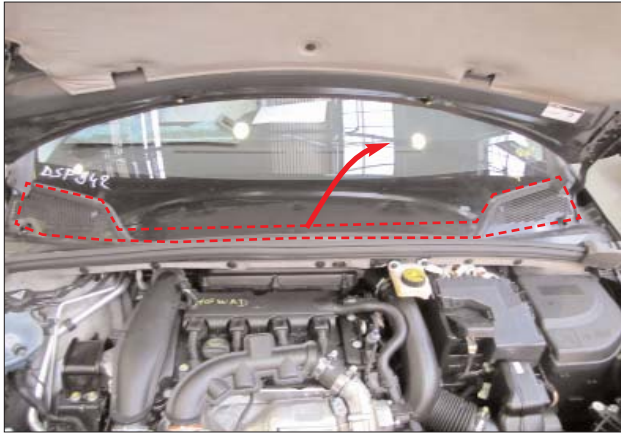

10

P

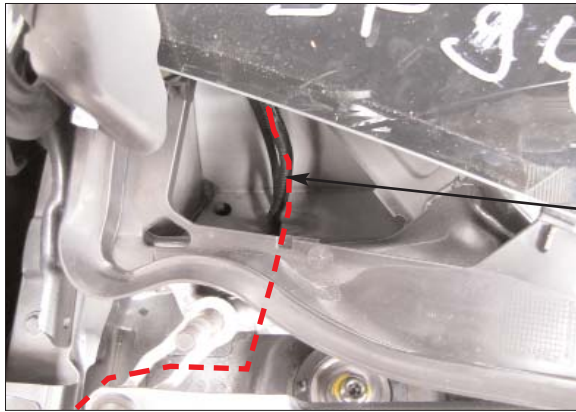
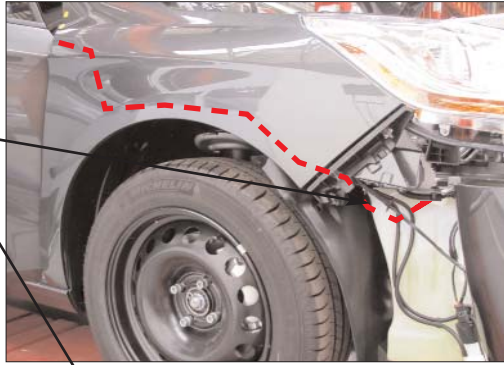

6542.FK



200 mm



11



12

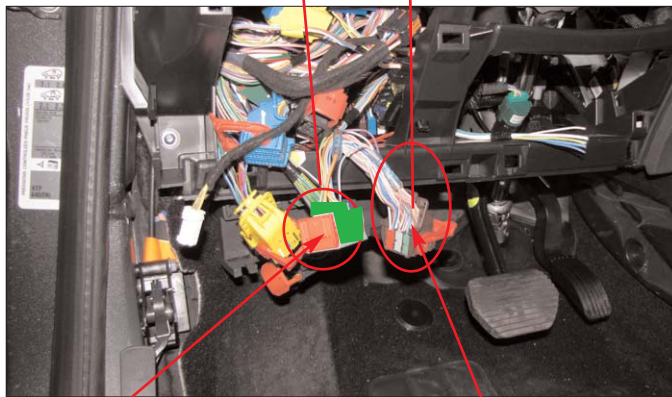
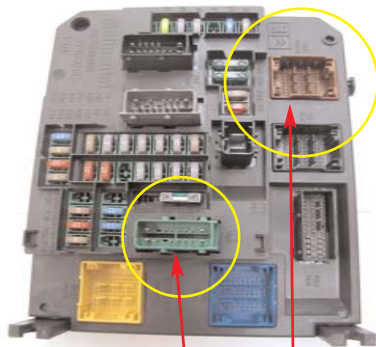

(+APC) - conn. VE 16V, pos. 8

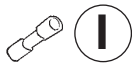

- conn. MR 60V, pos. 30



10 Nm±10%

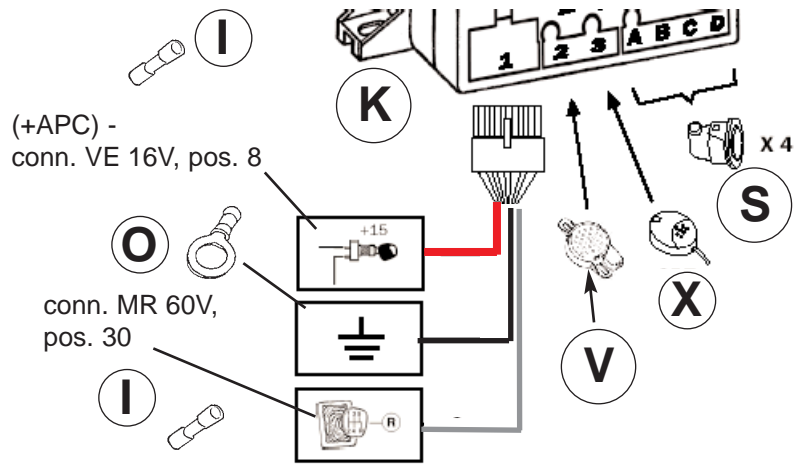

13

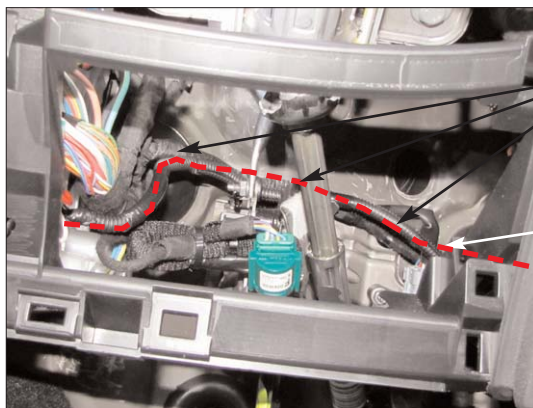

6542.FK



800 mm

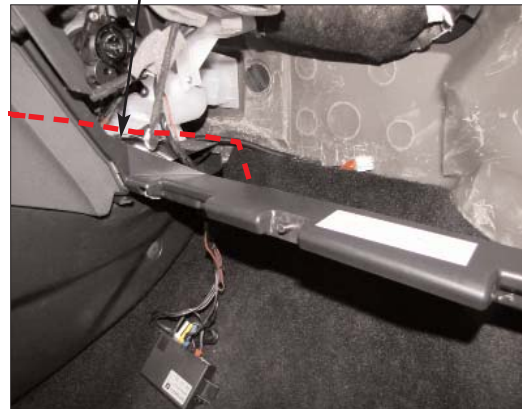
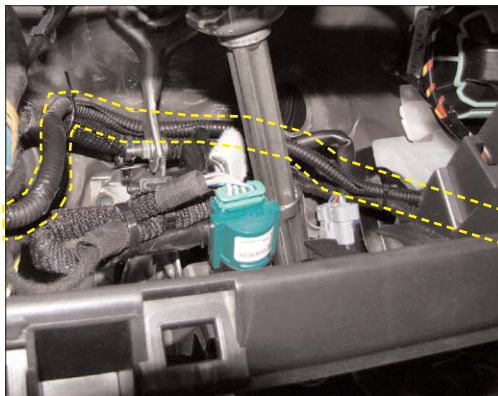

14



15

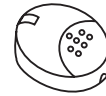

16

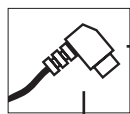

4x

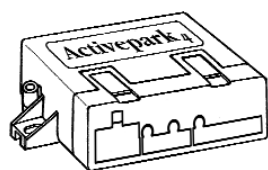
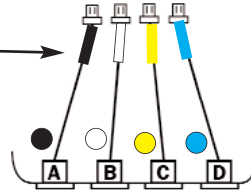
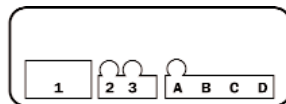

OFFSET



VOL.



SENS.

17

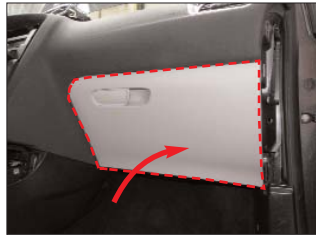

K



+ F

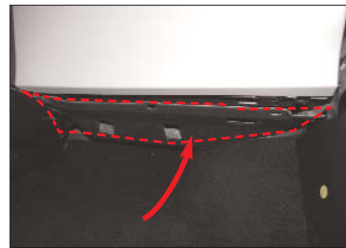

18

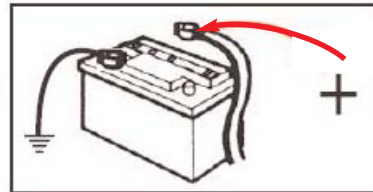

19

