

FR NOTICE DE POSE A USAGE PROFESSIONNEL / LES PHOTOS ET LES DESSINS NE SONT PAS CONTRACTUELS
GB FITTING INSTRUCTIONS FOR PROFESSIONAL FITTERS / THE PHOTOGRAPHS AND THE DRAWINGS ARE NOT CONTRACTUAL
ES INSTRUCCIONES DE MONTAJE PARA USO PROFESIONAL / LAS FOTOGRAFÍAS Y LOS DIBUJOS NO SON CONTRACTUALES
P MANUAL DE MONTAGEM PARA UTILIZAÇÃO PROFISSIONAL / AS FOTOGRAFIAS E OS DESENHOS NÃO SÃO CONTRATUAIS
DE MONTAGEANLEITUNG FÜR PROFESSIONNELLEN EINSATZ / DIE FOTOS UND DIE ZEICHNUNGEN SIND NICHT VERTRAGLICH
IT ISTRUZIONI DI POSA AD USO PROFESSIONALE / LE FOTOGRAFIE ED I DISEGNI NON SONO CONTRATTUALI

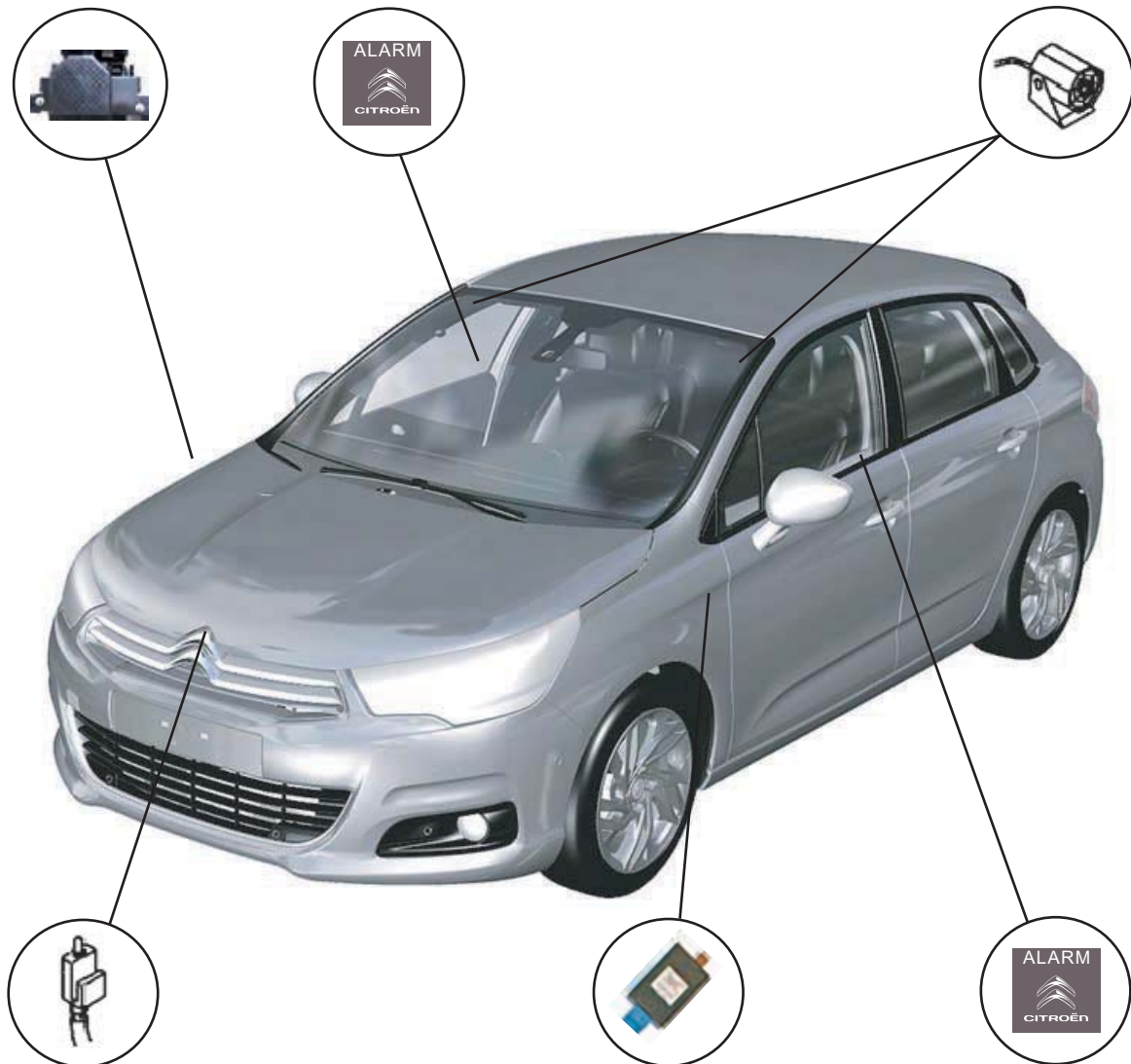



10/15 Volts



- 40 ° / + 85 ° C



108 db



P. 4/10/11/14/15/16/17/19



VE/JN	MR	VI	NO	GR	JN	BA	BE	RG
F Vert/Jaune	Marron	Violet	Noir	Gris	Jaune	Blanc	Bleu	Rouge
D Grün/gelb	Braun	Violett	Schwarz	Grau	Gelb	WeiB	Blau	Rot
GB Green/yellow	Brown	Purple	Black	Grey	Yellow	White	Blue	Red
NL Groen/geel	Bruin	Violet	Zwart	Grijs	Geel	Wit	Blauw	Rood
P Verde/amarelo	Castanho	Violeta	Preto	Cinzento	Amarelo	Branco	Azul	Vermelho
I Verde/giallo	Marrone	Viola	Nero	Grigio	Giallo	Bianco	Blu	Rosso
E Verde/amarillo	Marron	Violeta	Negro	Gris	Amarillo	Blanco	Azul	Rojo

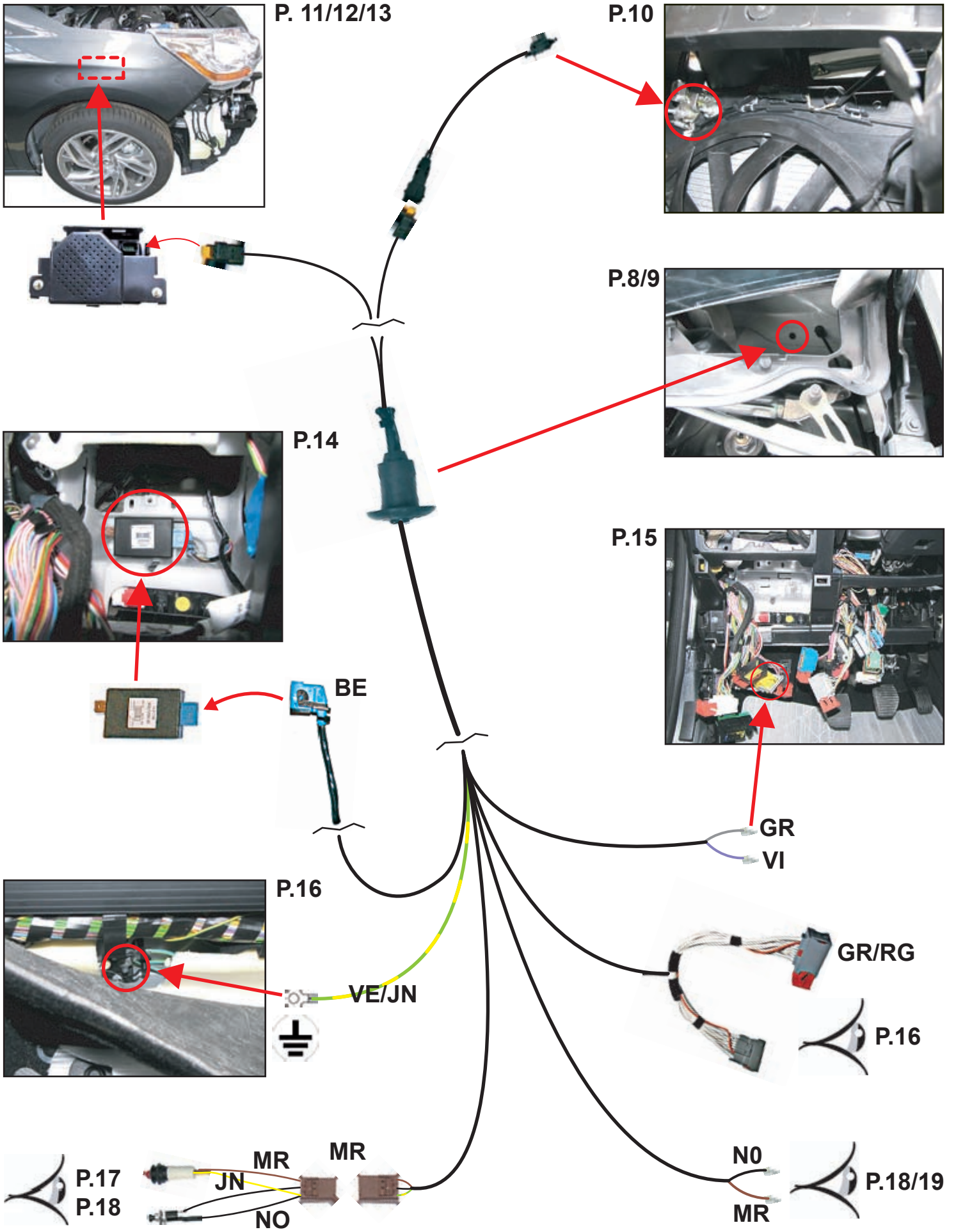

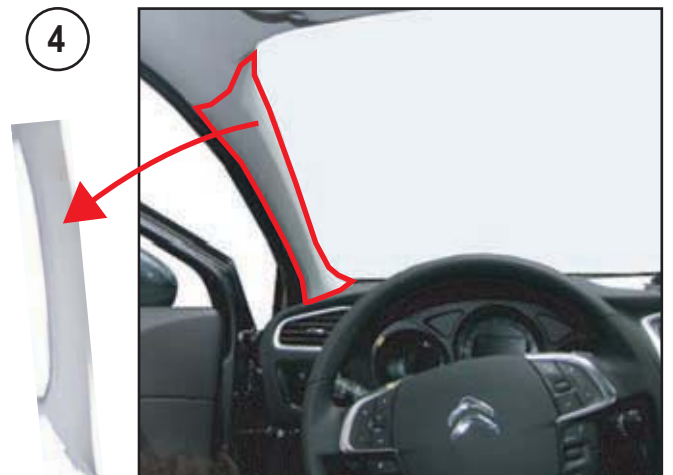
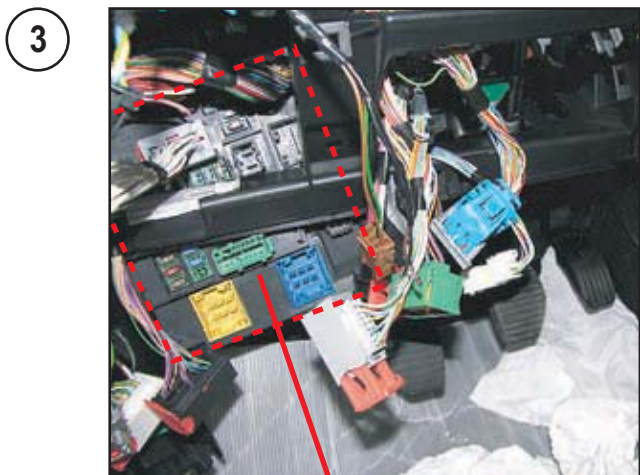
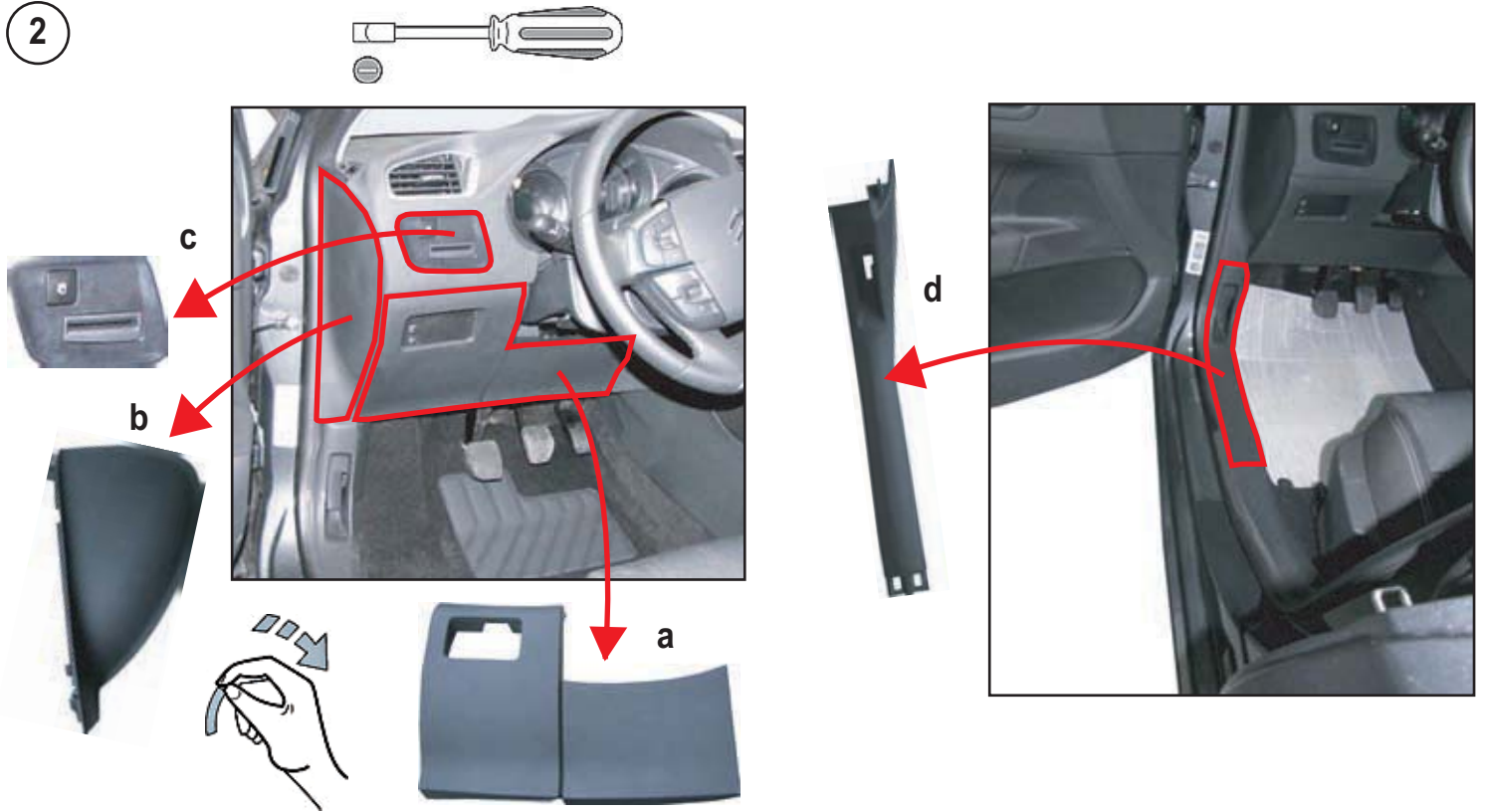

5



6



1 x 
TX 30

1 x 
TX 30





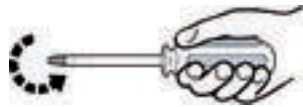

7 x 
TX 20



7



 = 4 x 

 = 3 x 

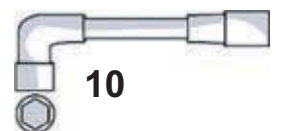

10

8

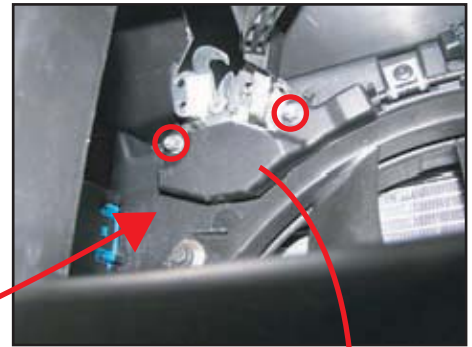
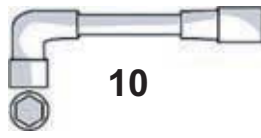

○ = 2 x 



9

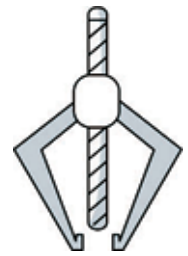
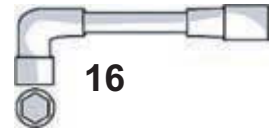
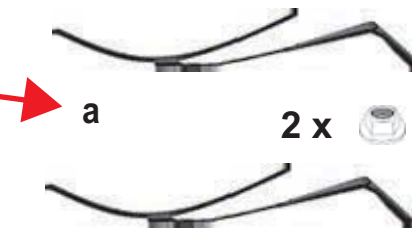
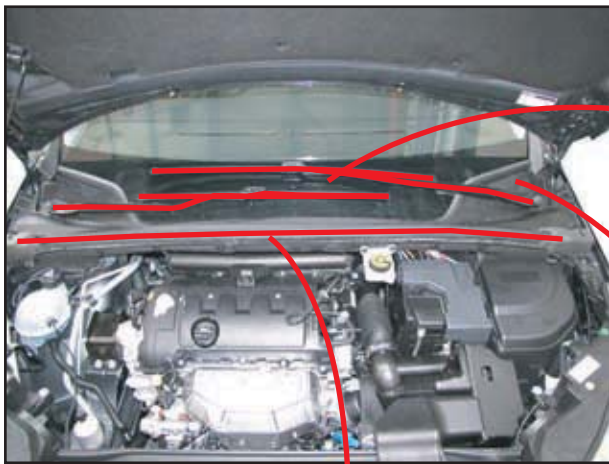

10



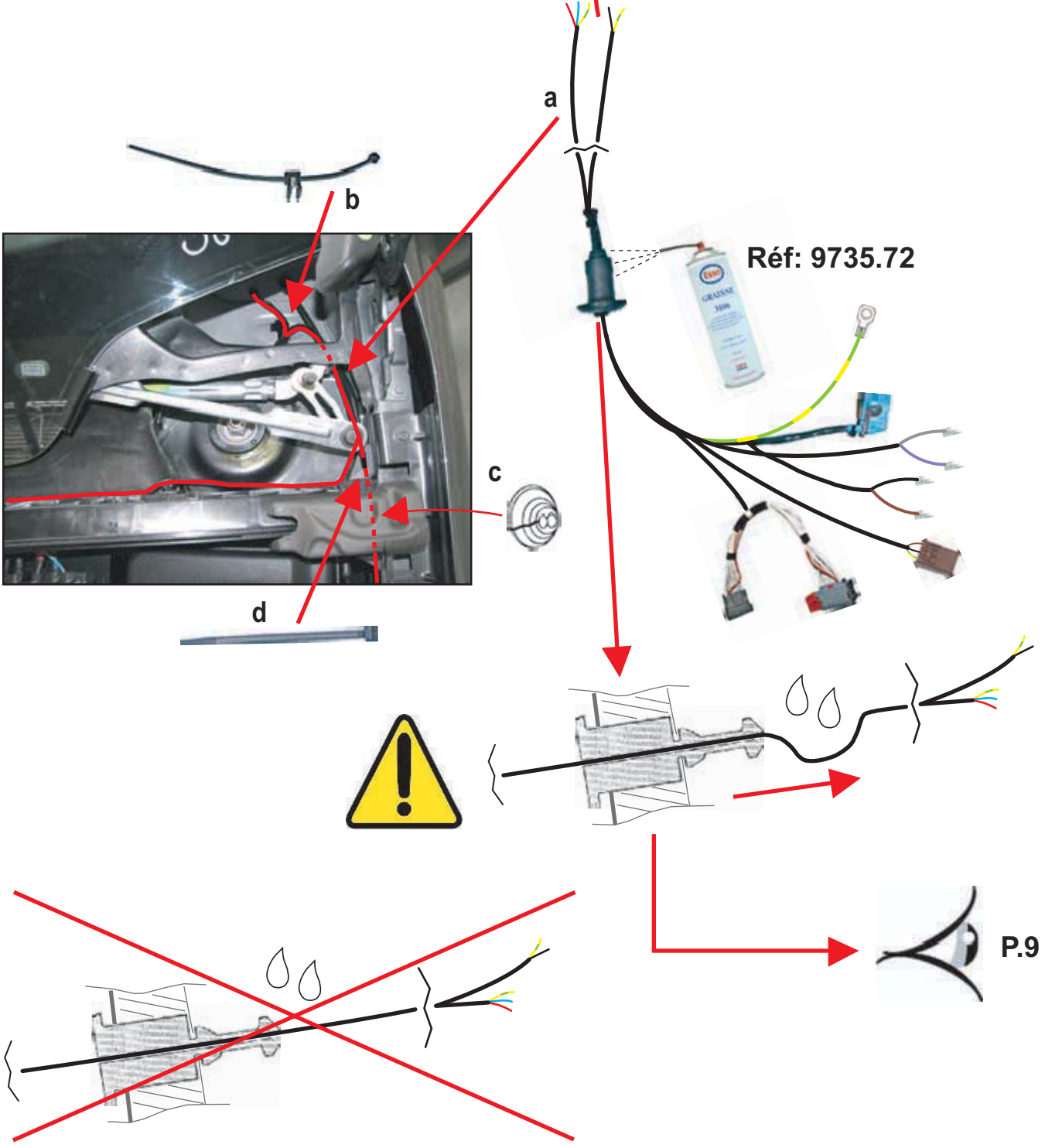

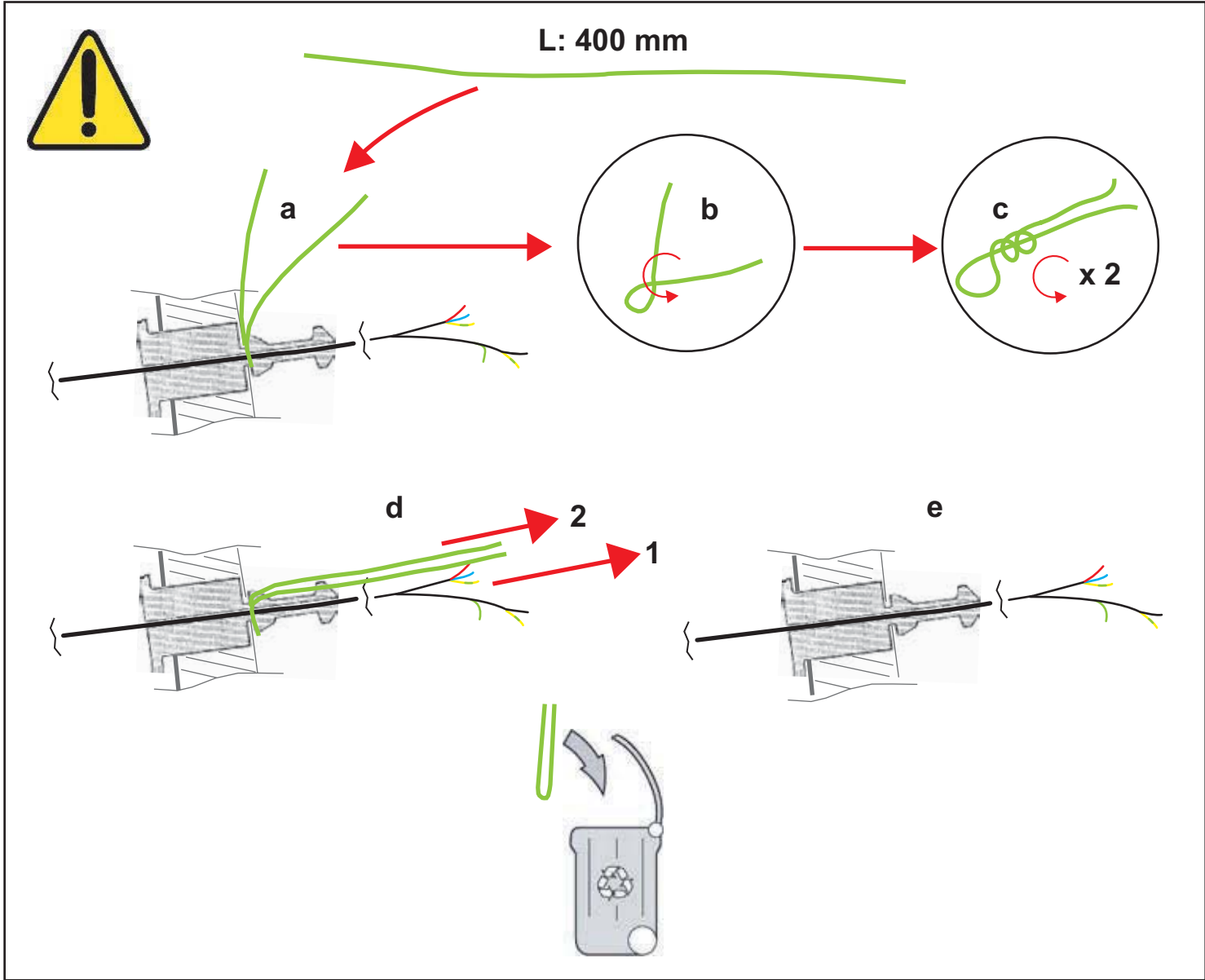

12

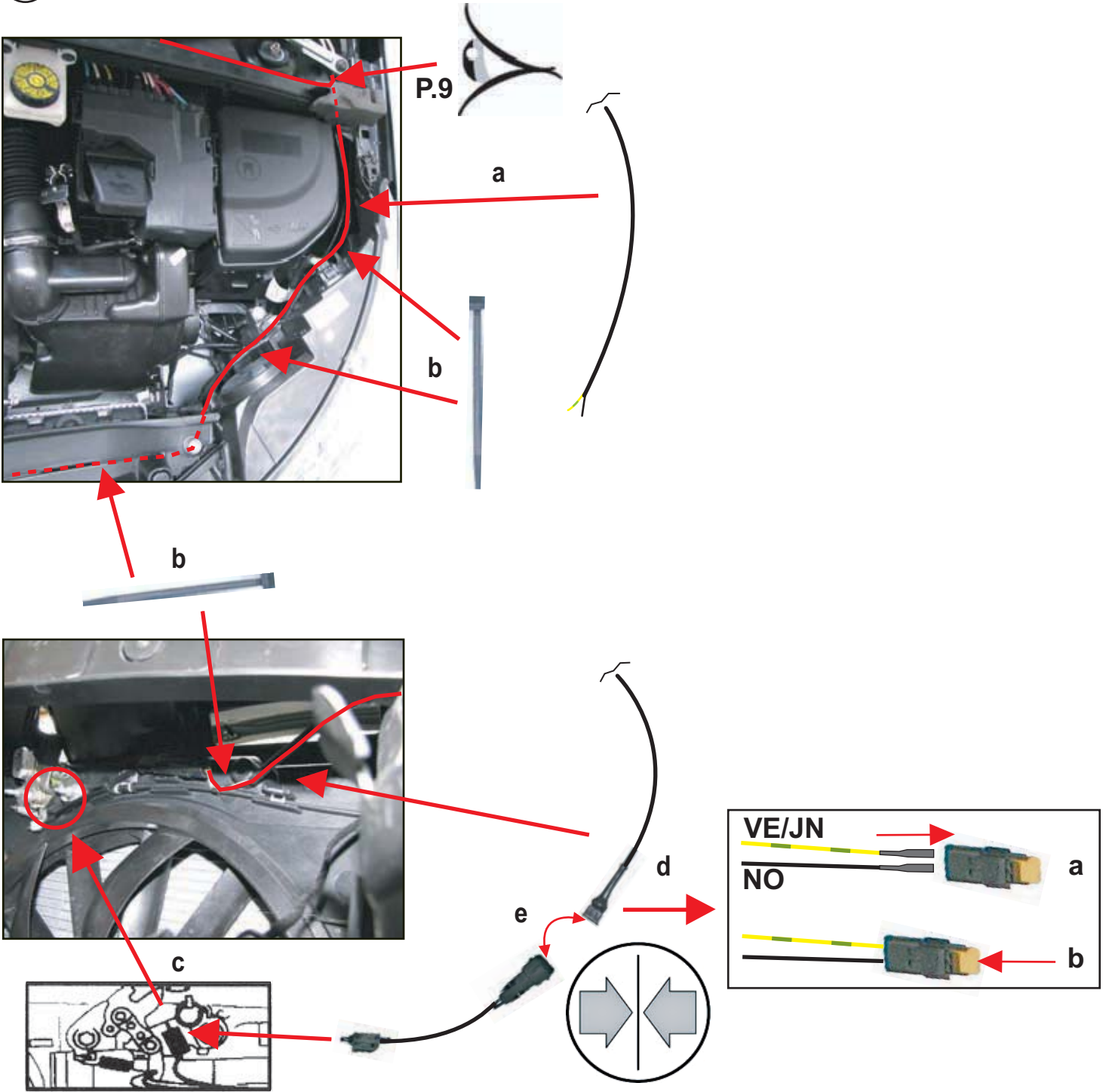

13



14

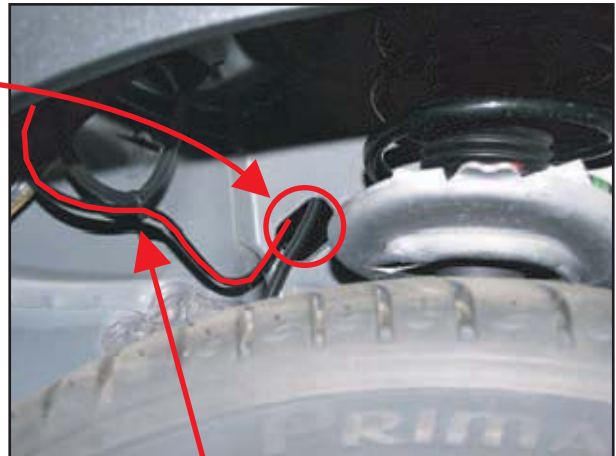
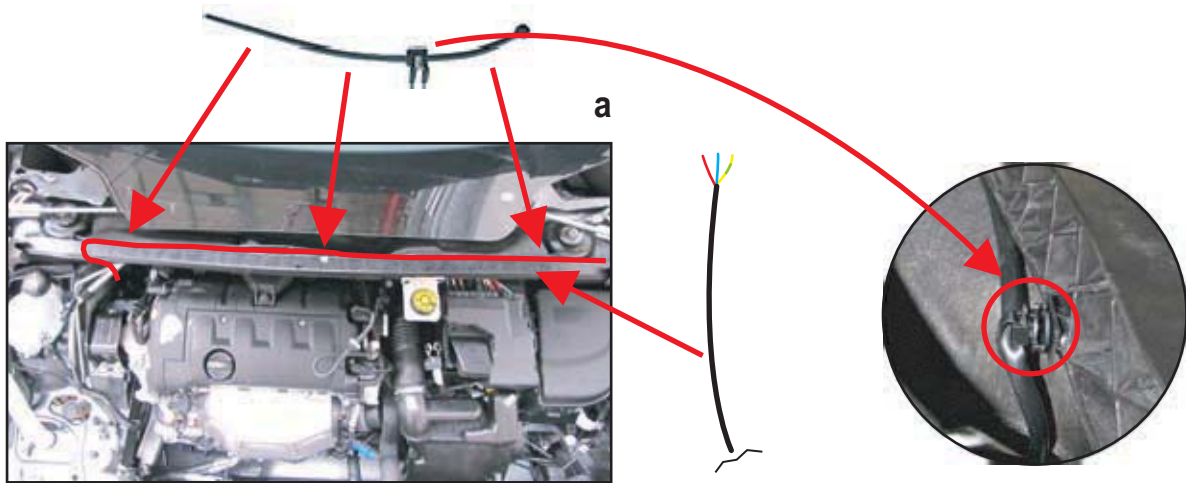

15

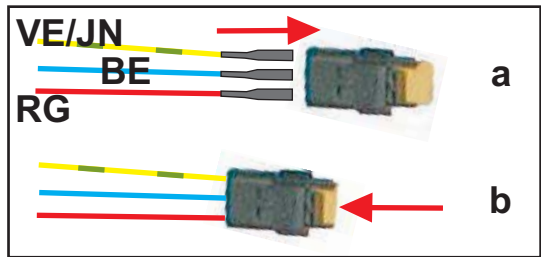
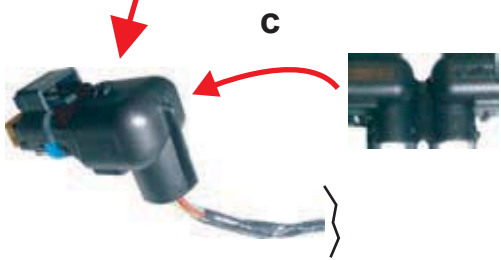
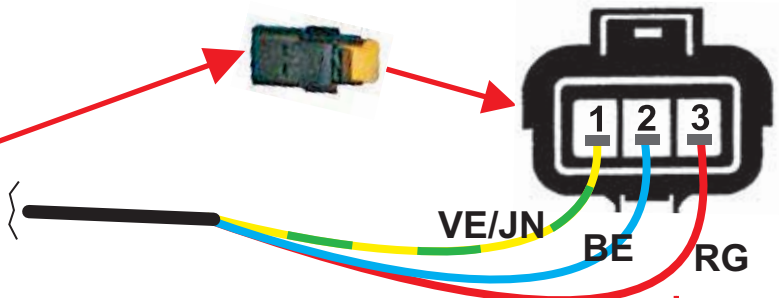

16

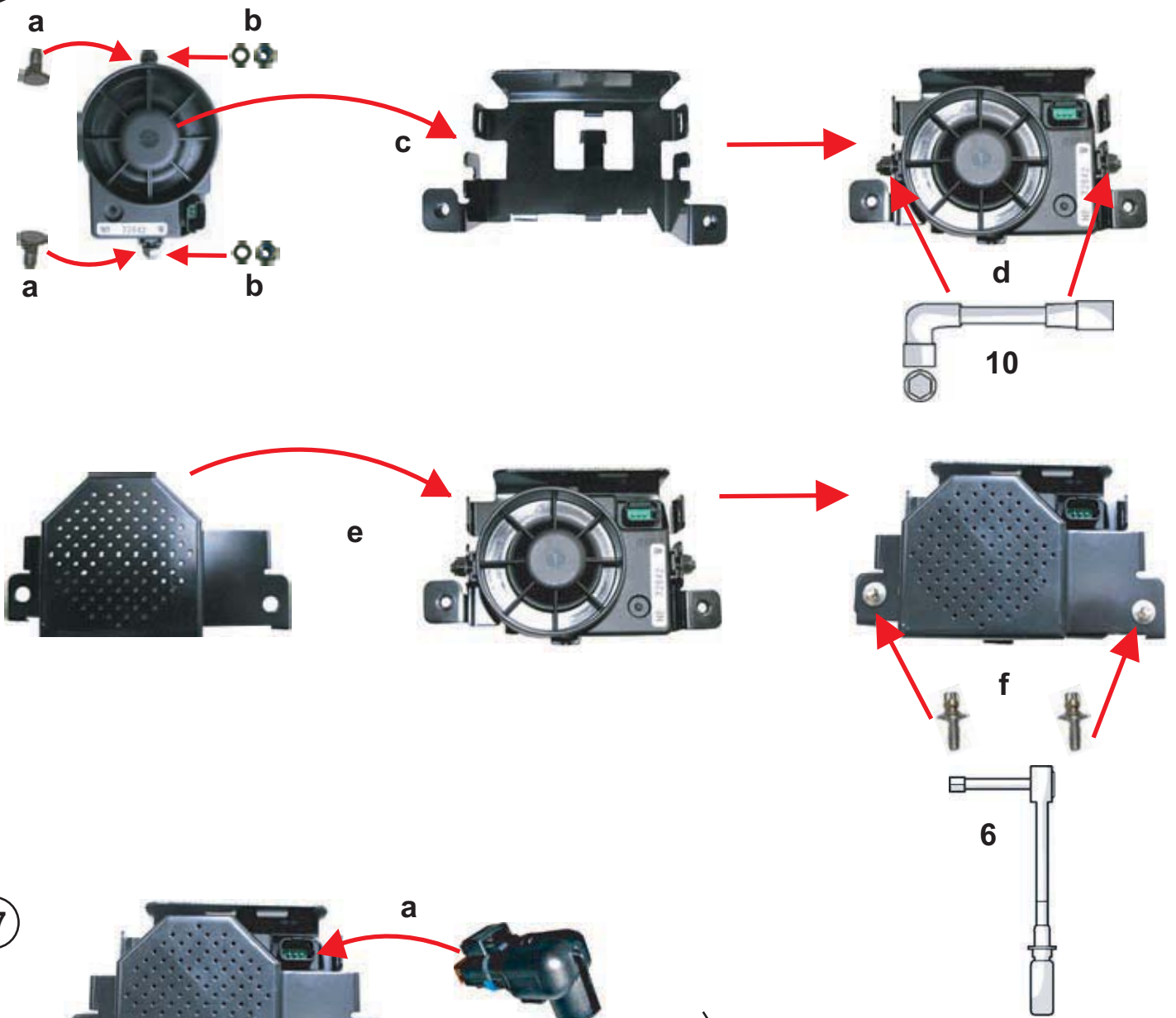

17

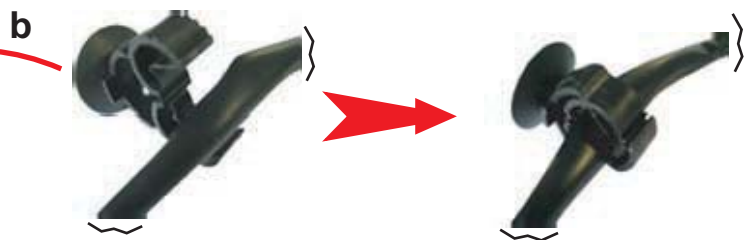
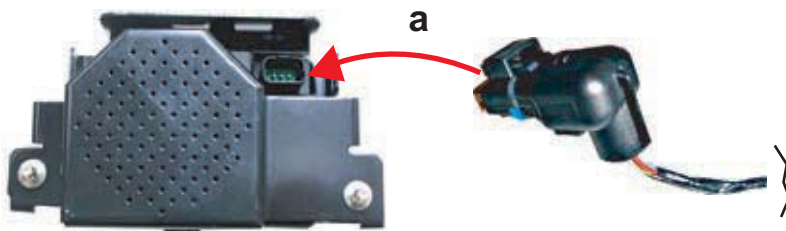



a

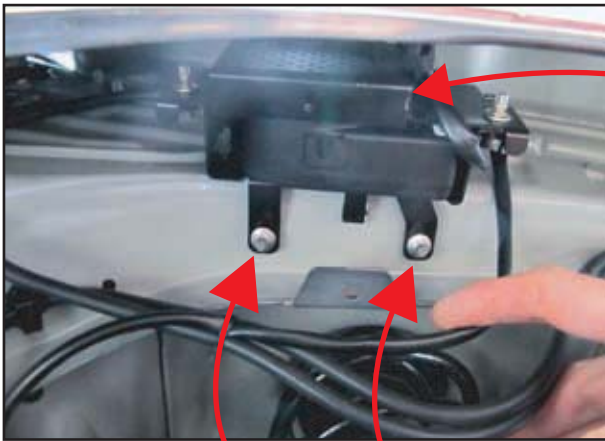
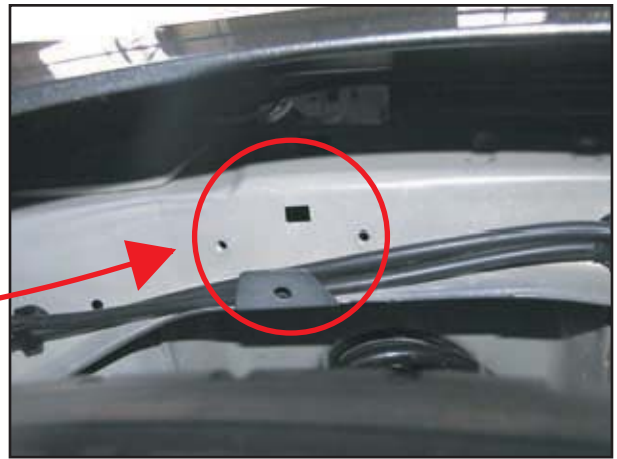

b

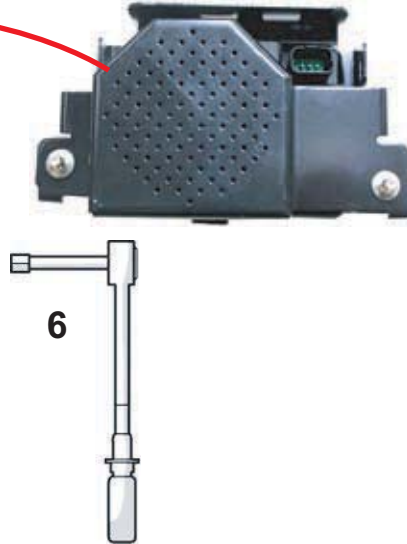

d



19

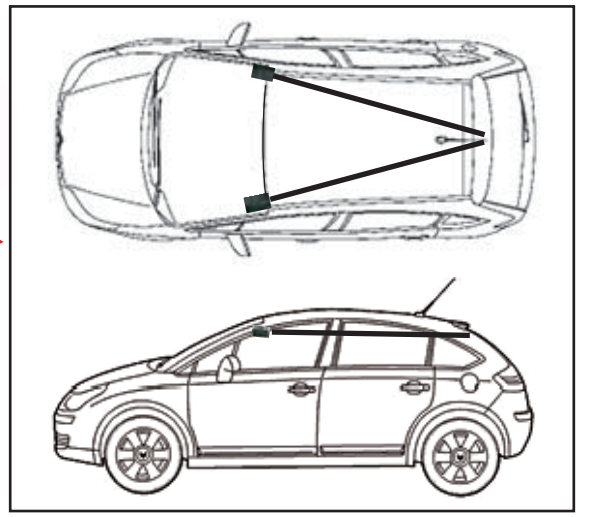
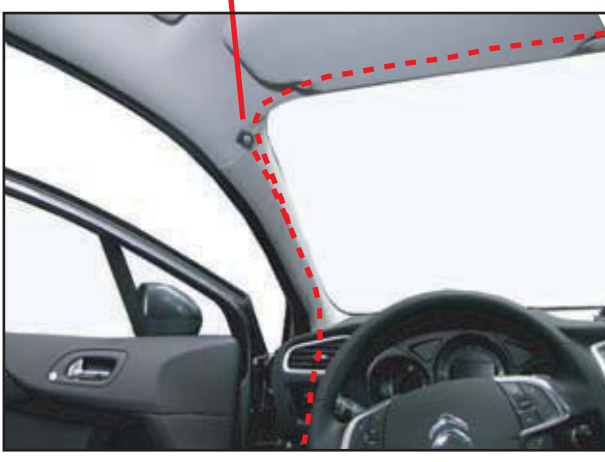
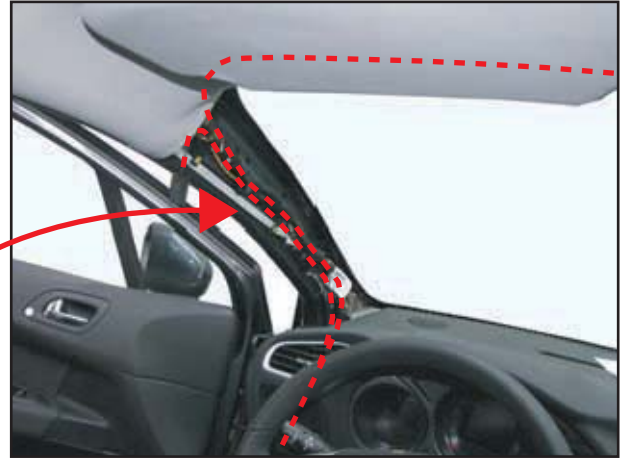

20

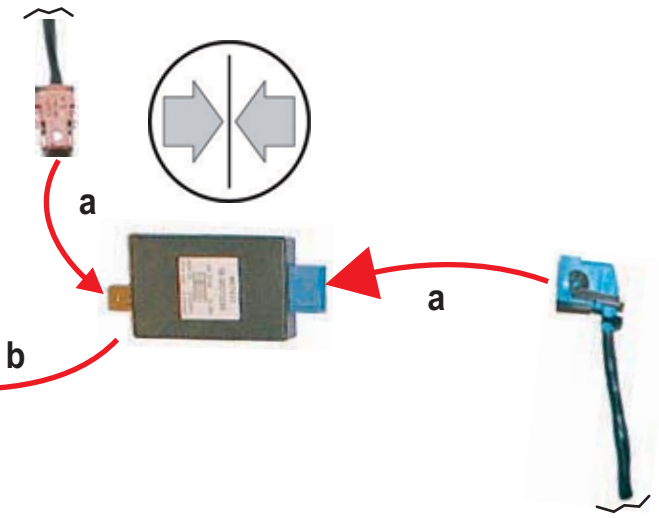
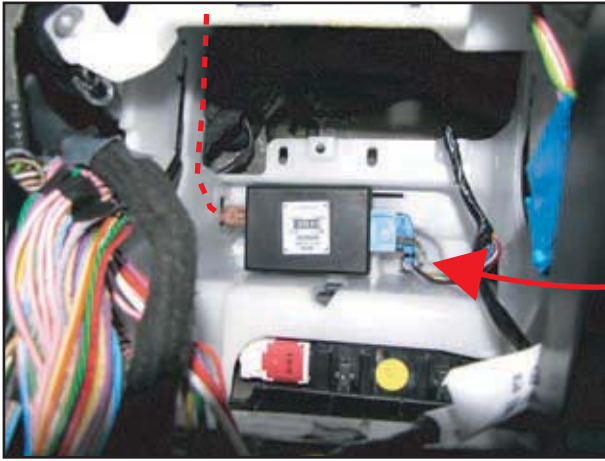

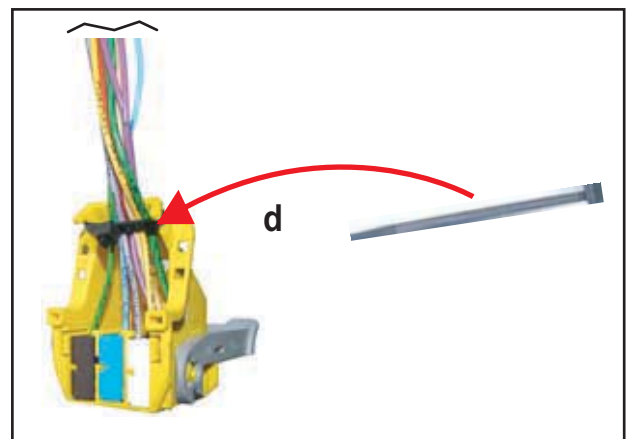
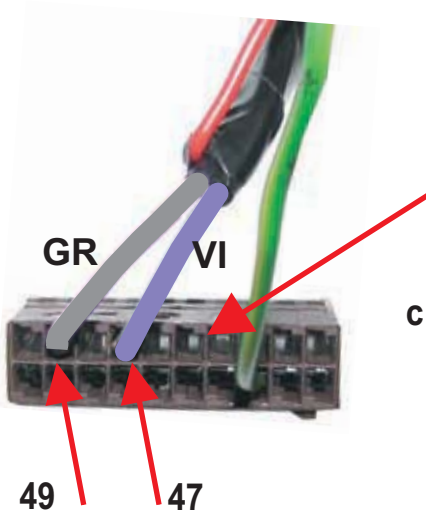
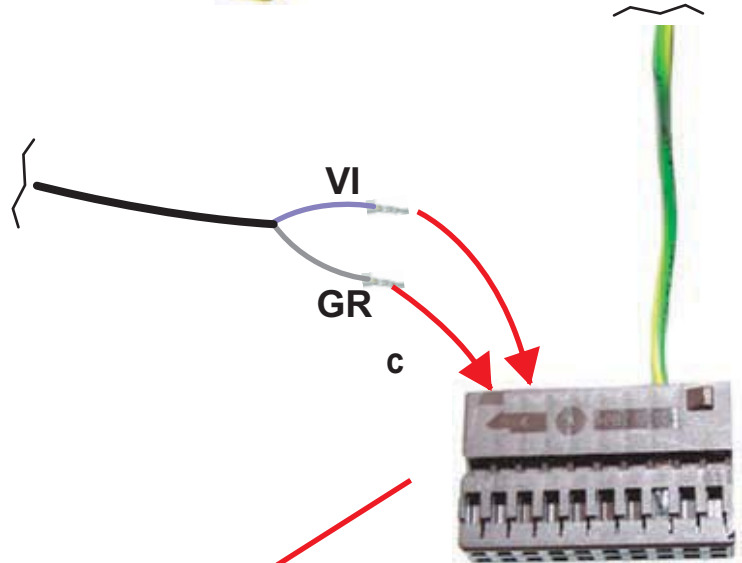
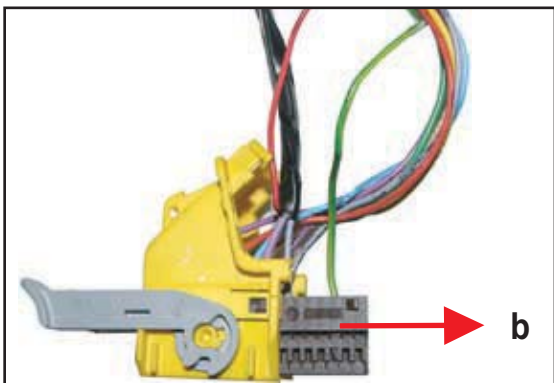
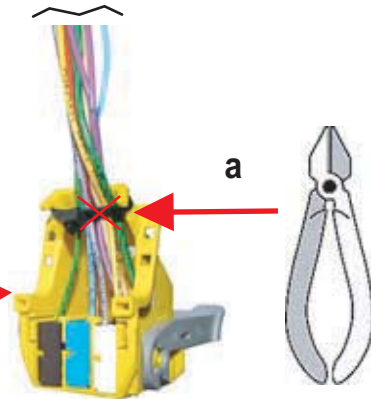
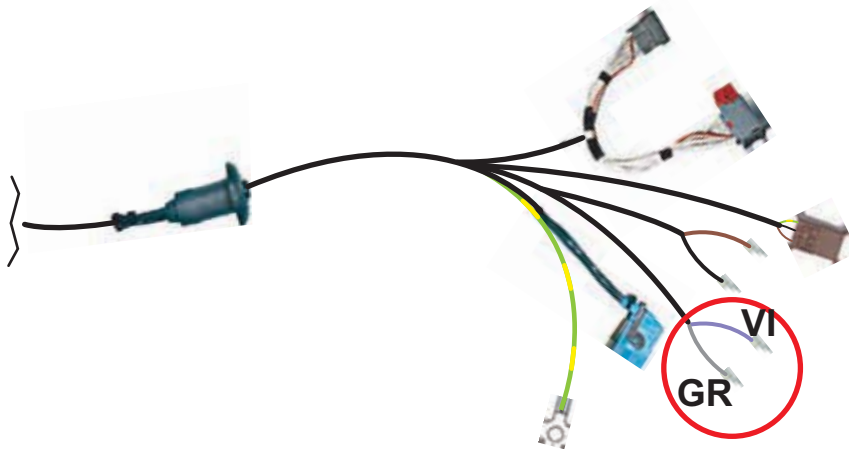

22

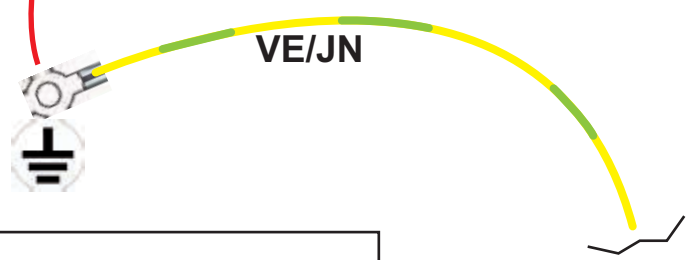
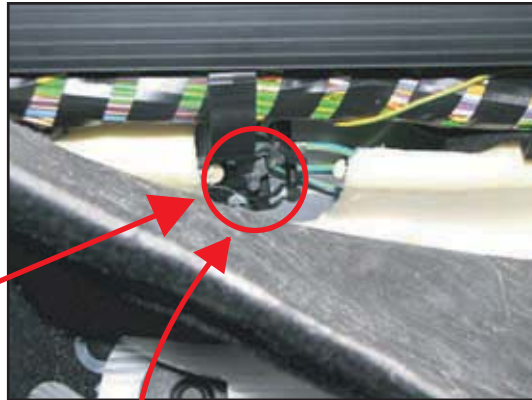
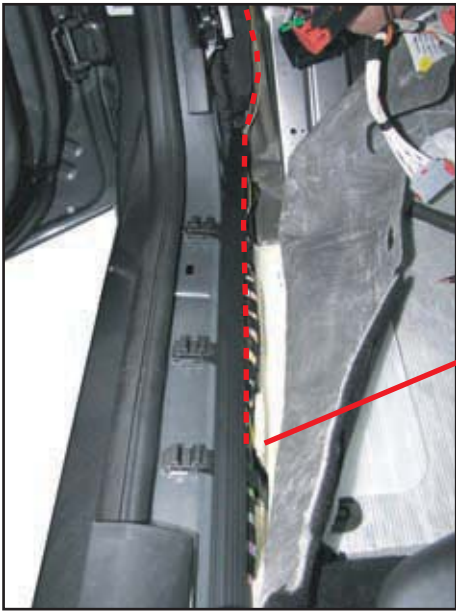
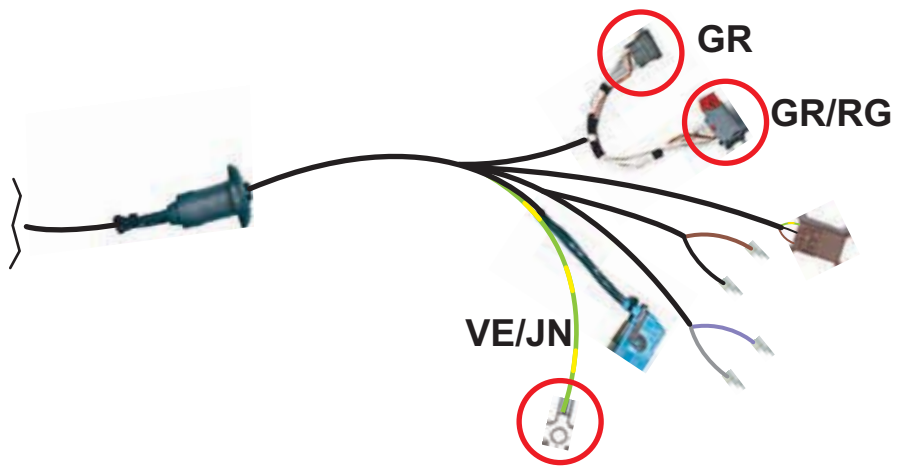

10

10 N.m +/- 10%

23

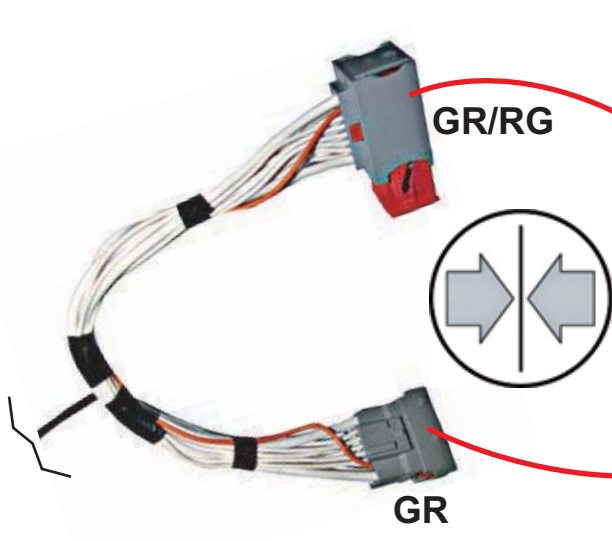



P.18

26



24

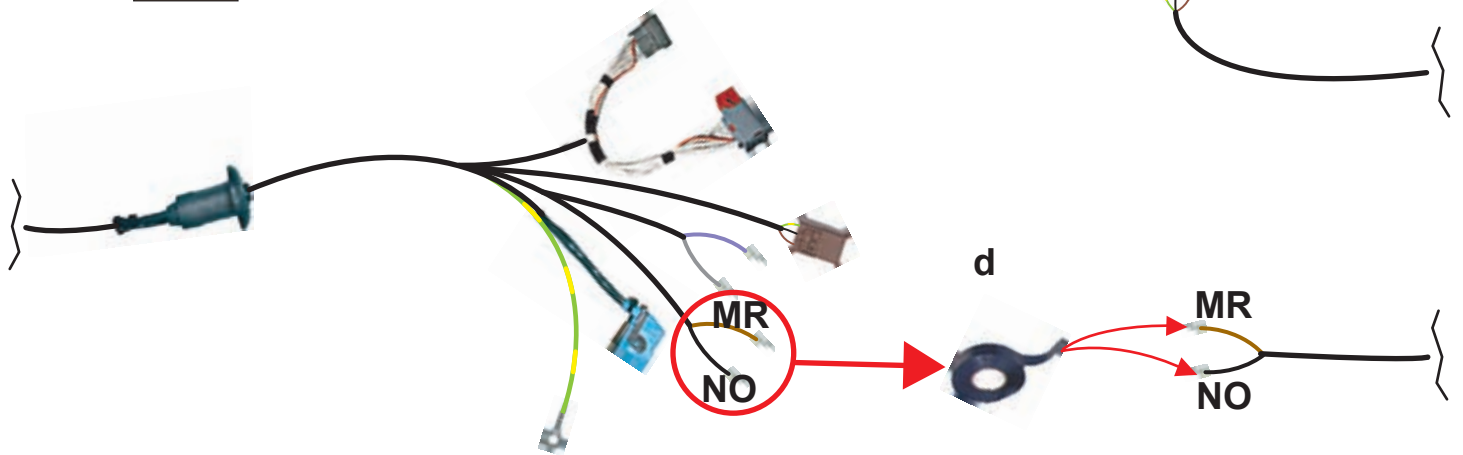
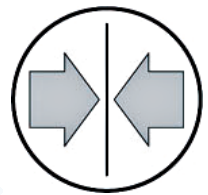
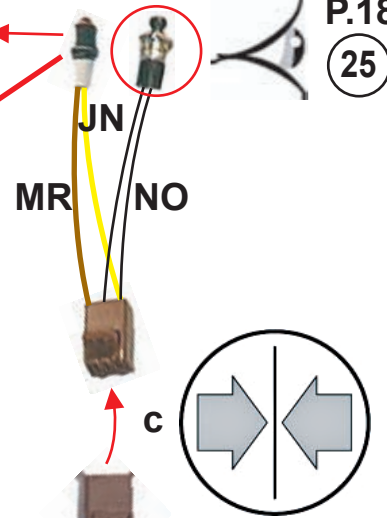
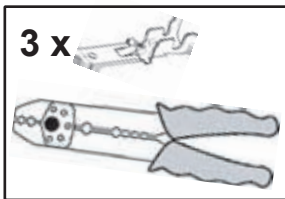
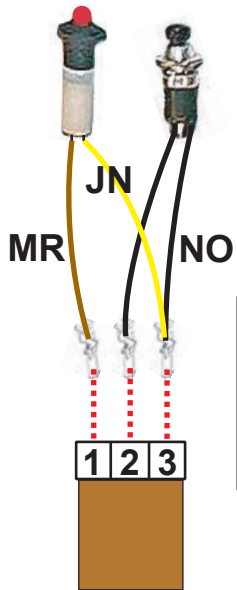

25

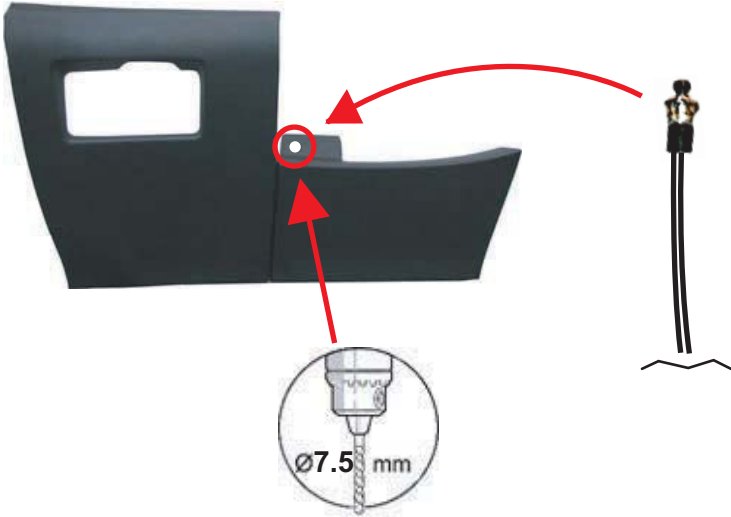

26

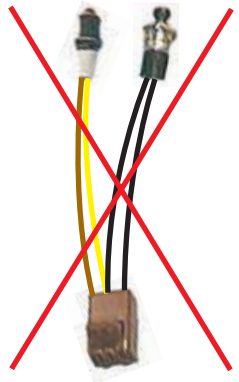
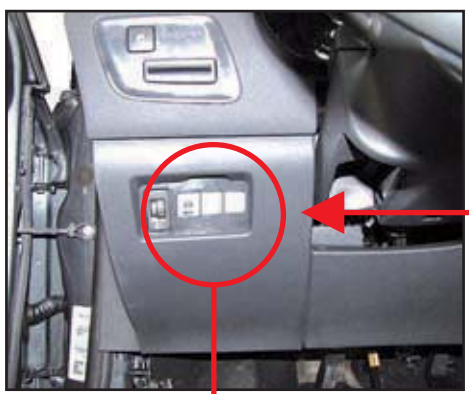

Réf: 6490.KP

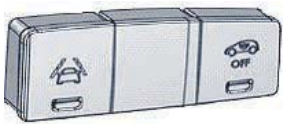

Réf: 6490.KR

27

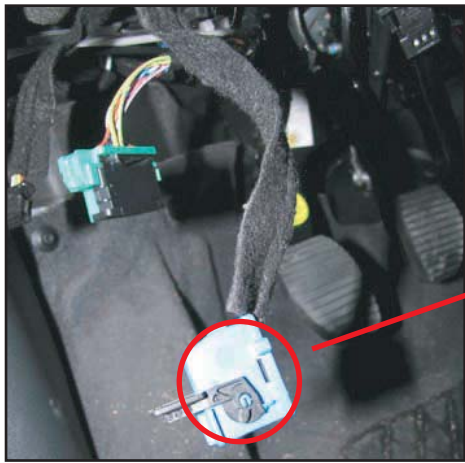

BE

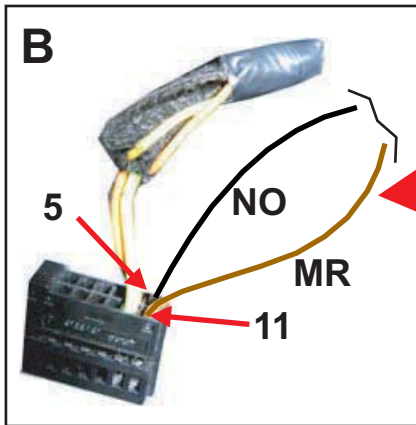
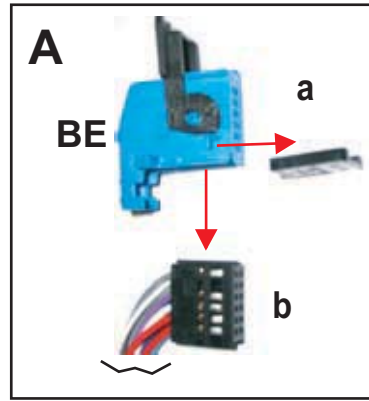

NO
MR

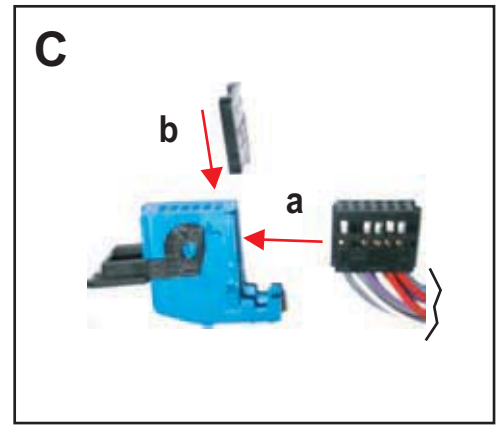

28

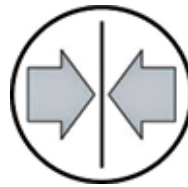

29



BSI

30



31

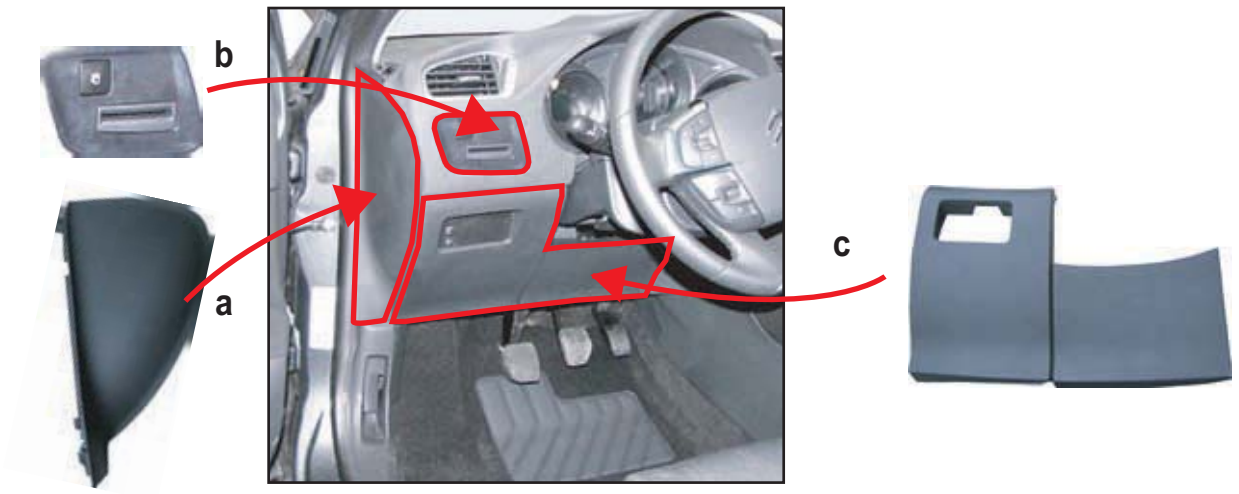

32

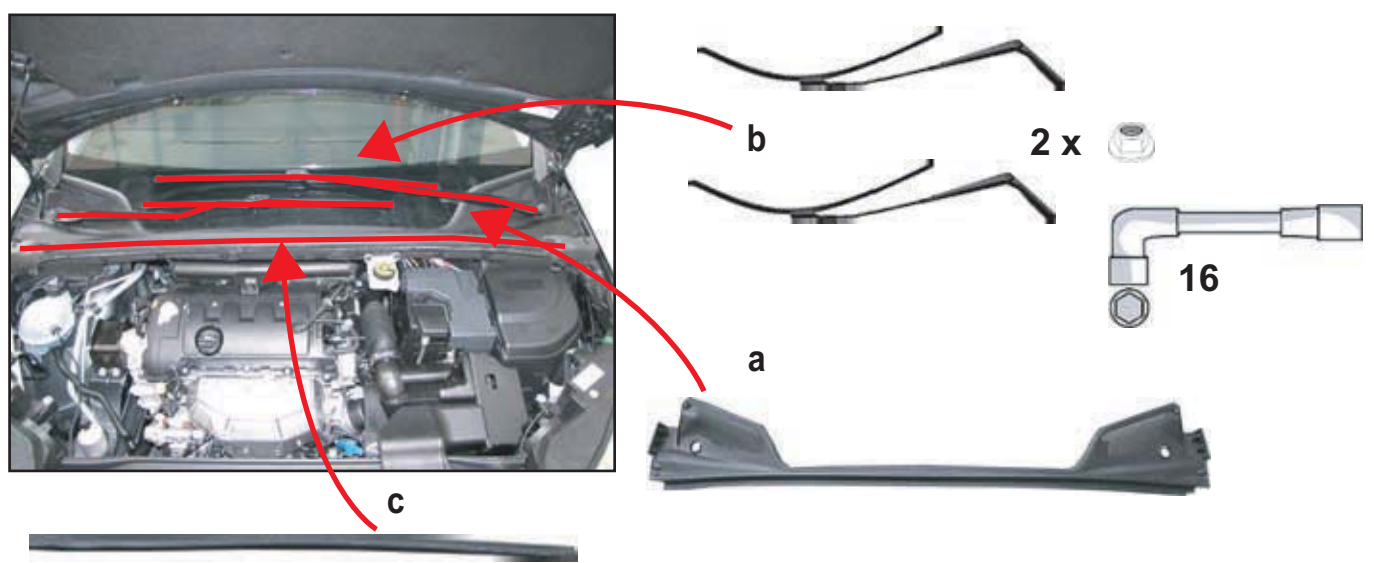

33



1 x  TX 30

1 x  TX 30

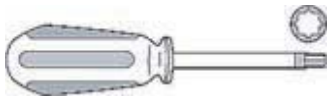

7 x  TX 20

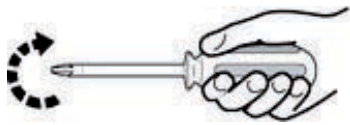

34

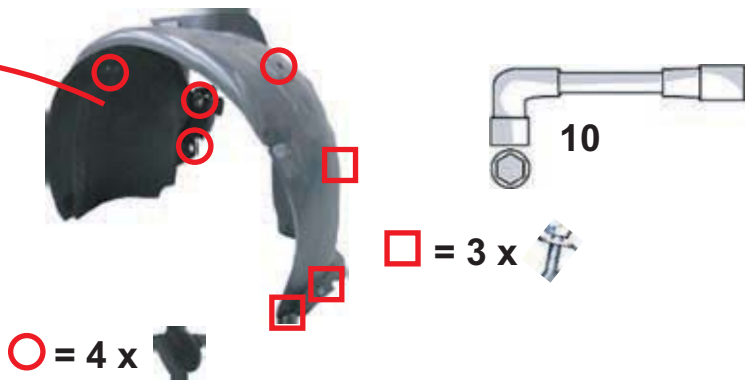

35

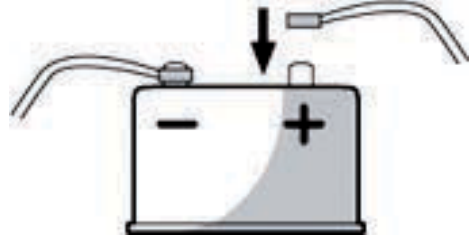

1 min

36



37



38

