



ACT 1952

C4 Picasso

Réf. : 16 062 177 80

FR NOTICE DE POSE A USAGE PROFESSIONNEL / LES PHOTOS ET LES DESSINS NE SONT PAS CONTRACTUELS
 GB FITTING INSTRUCTIONS FOR PROFESSIONAL FITTERS / THE PHOTOGRAPHS AND THE DRAWINGS ARE NOT CONTRACTUAL
 ES INSTRUCCIONES DE MONTAJE PARA USO PROFESIONAL / LAS FOTOGRAFÍAS Y LOS DIBUJOS NO SON CONTRACTUALES
 P MANUAL DE MONTAGEM PARA UTILIZAÇÃO PROFISSIONAL / AS FOTOGRAFIAS E OS DESENHOS NÃO SÃO CONTRATUAIS
 DE MONTAGEANLEITUNG FÜR PROFESSIONNELLEN EINSATZ / DIE FOTOS UND DIE ZEICHNUNGEN SIND NICHT VERTRAGLICH
 IT ISTRUZIONI DI POSA AD USO PROFESSIONALE / LE FOTOGRAFIE ED I DISEGNI NON SONO CONTRATTUALI
 NL MONTAGEHANDLEIDING VOOR PROFESSIONEEL GEBRUIK / DE FOTO'S EN DE TEKENINGEN ZIJN NIET CONTRACTUEEL

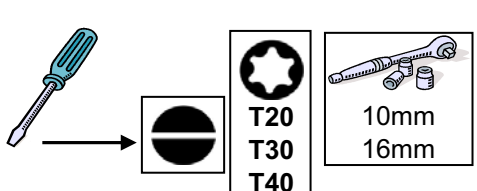
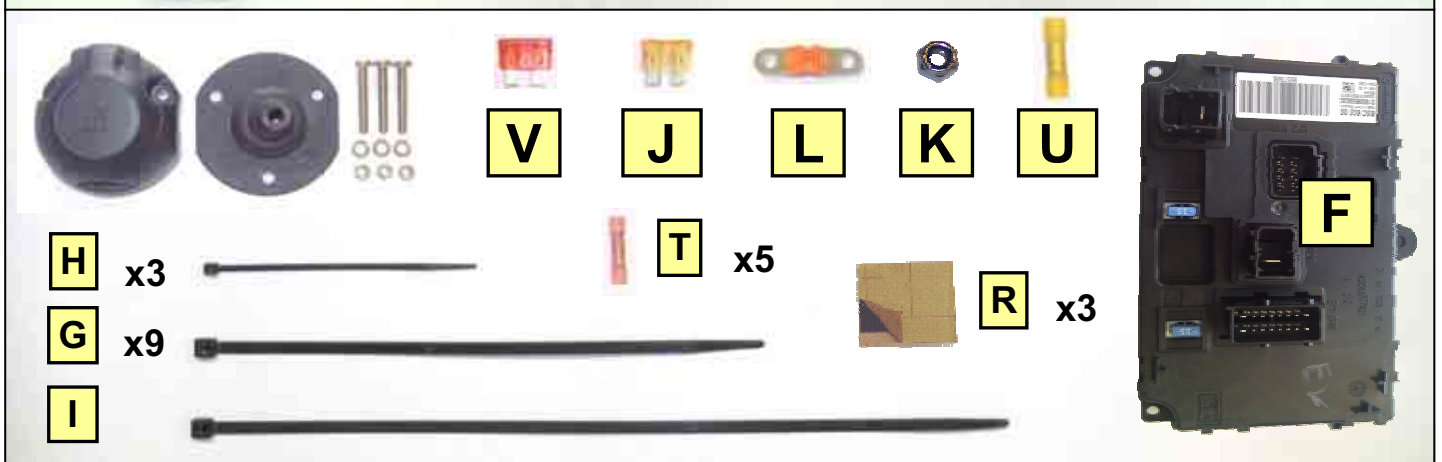
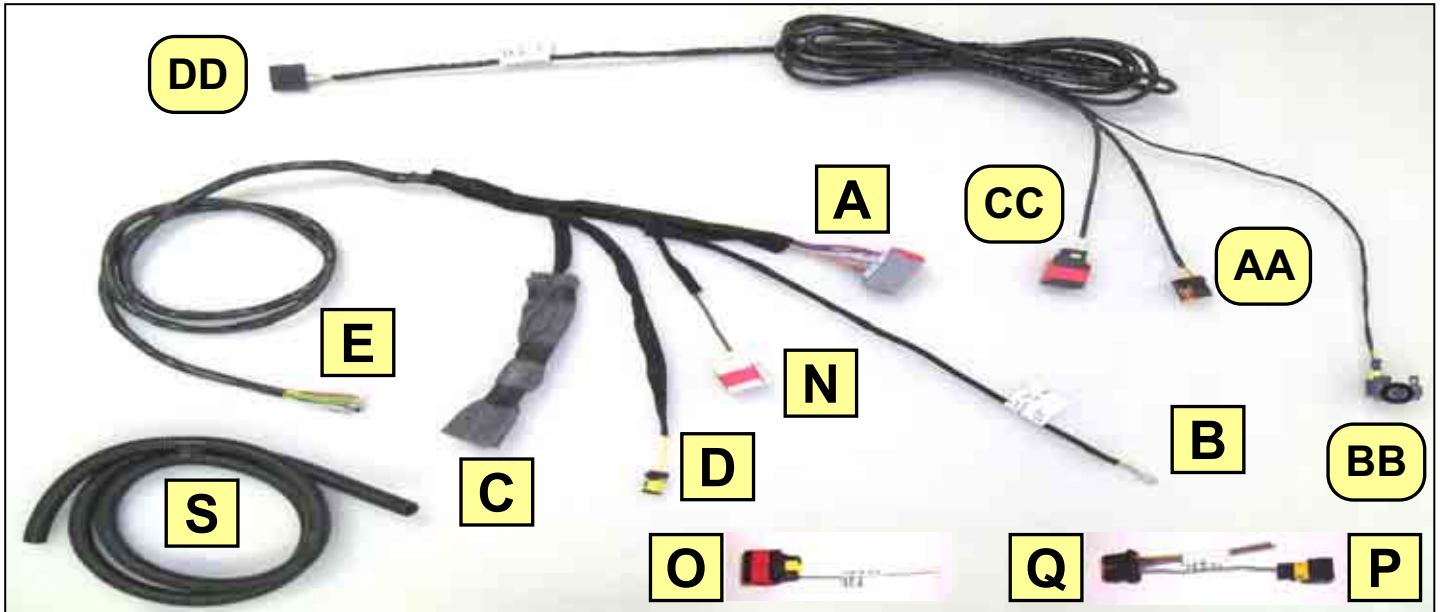

OPR → | 12530

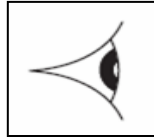

PAGE 3/24

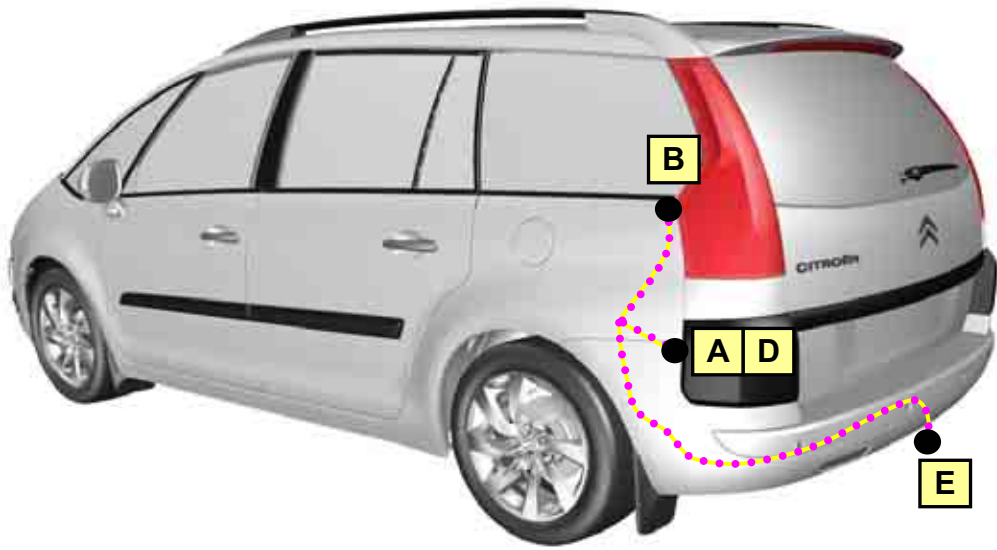

OPR 12531 | →



PAGE 14/24

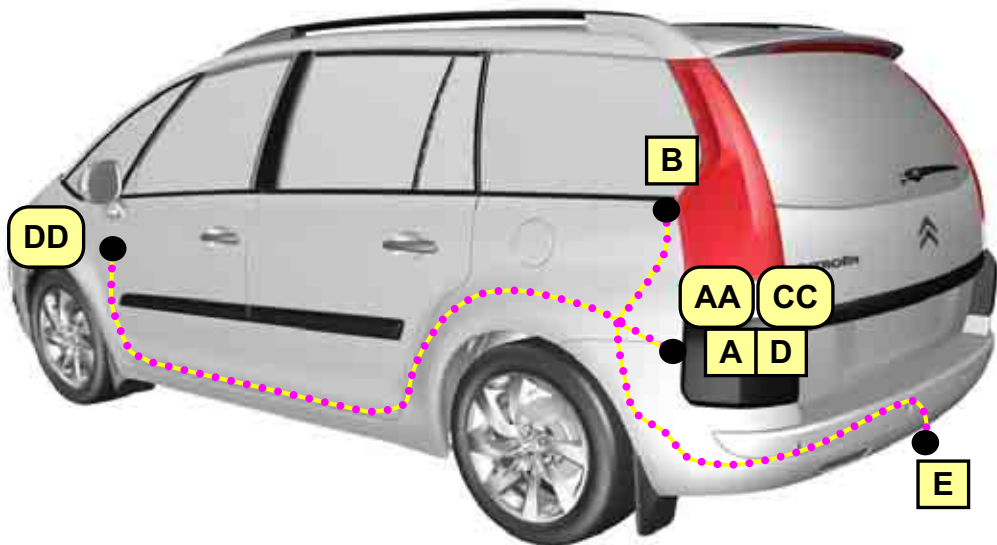



2



13



14



30

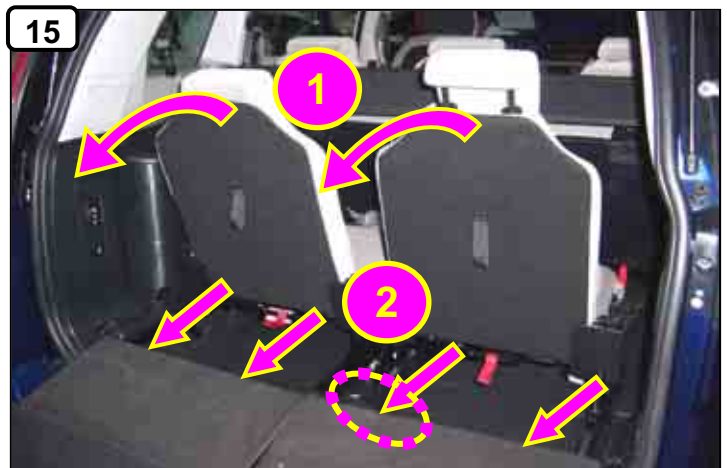



2



13



14



30

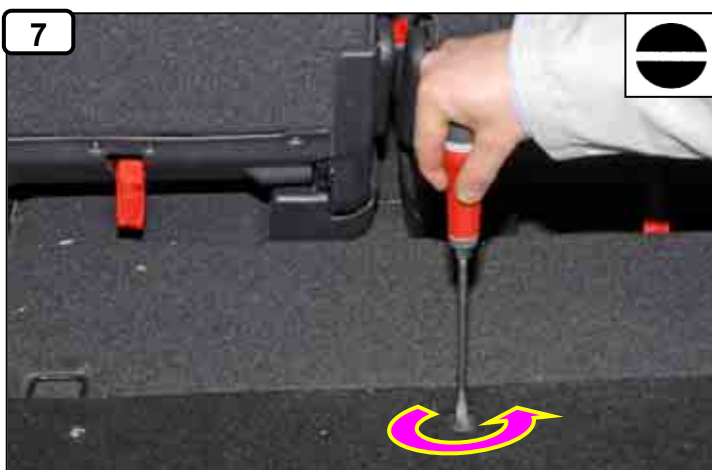
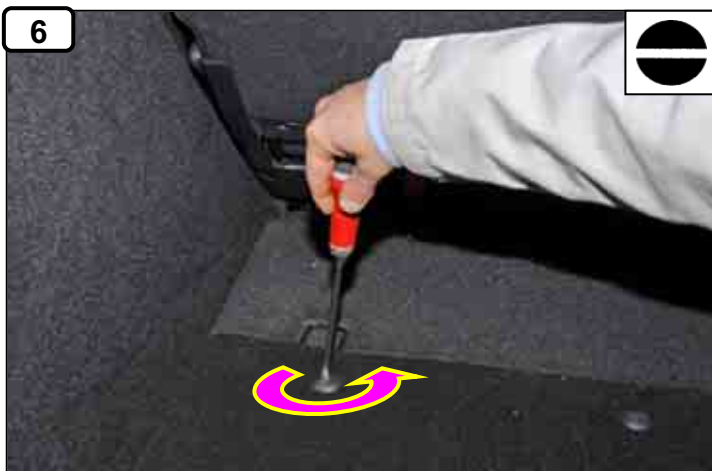
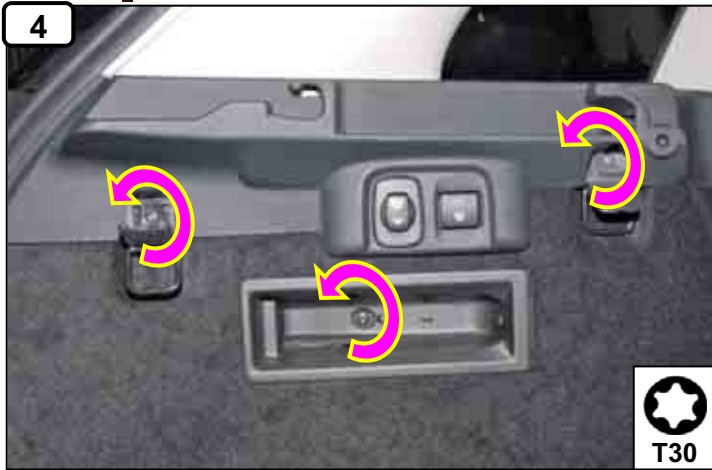



2



13



14



30

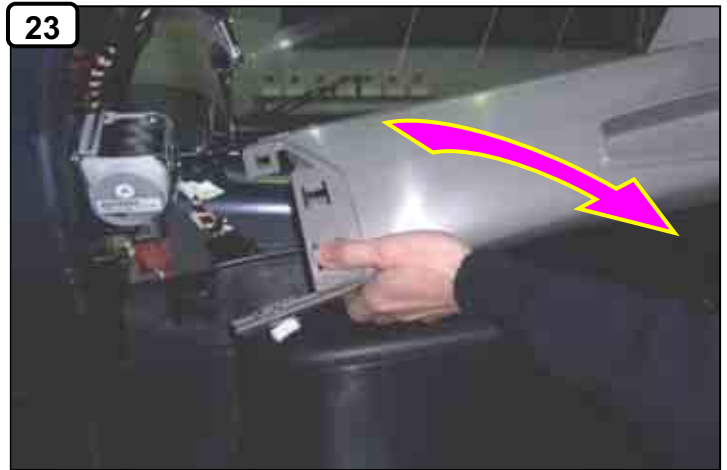



2



13



14



30

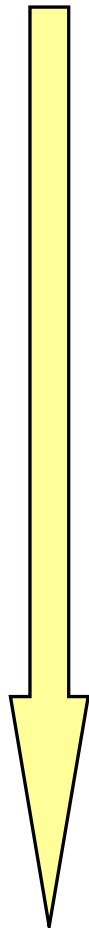
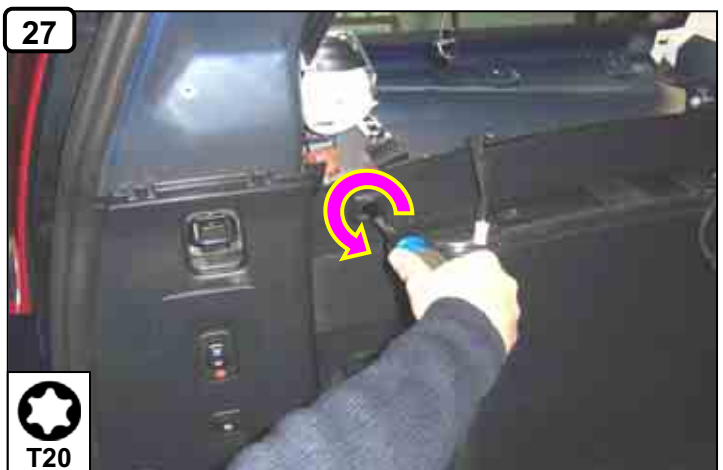
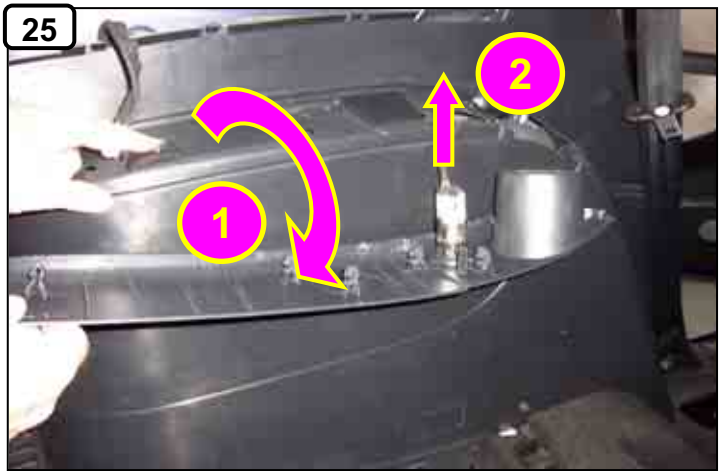



14



30

28



29

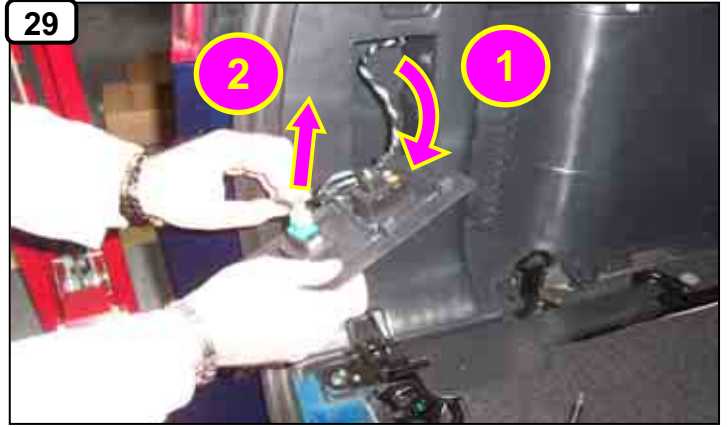

30



OR 11558 | → 12530



31



33



31



32

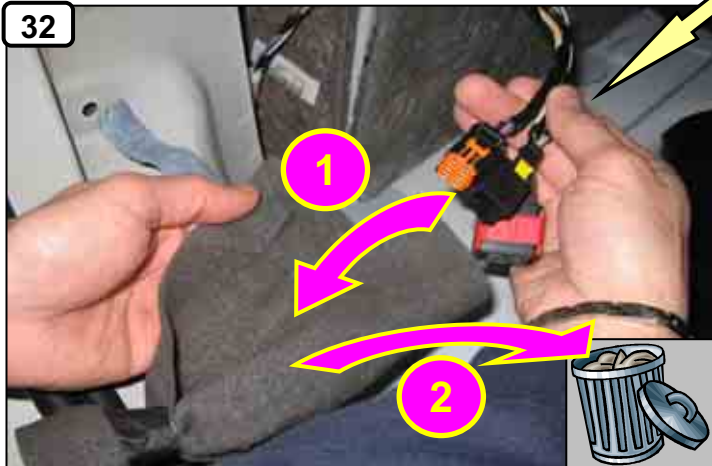

33



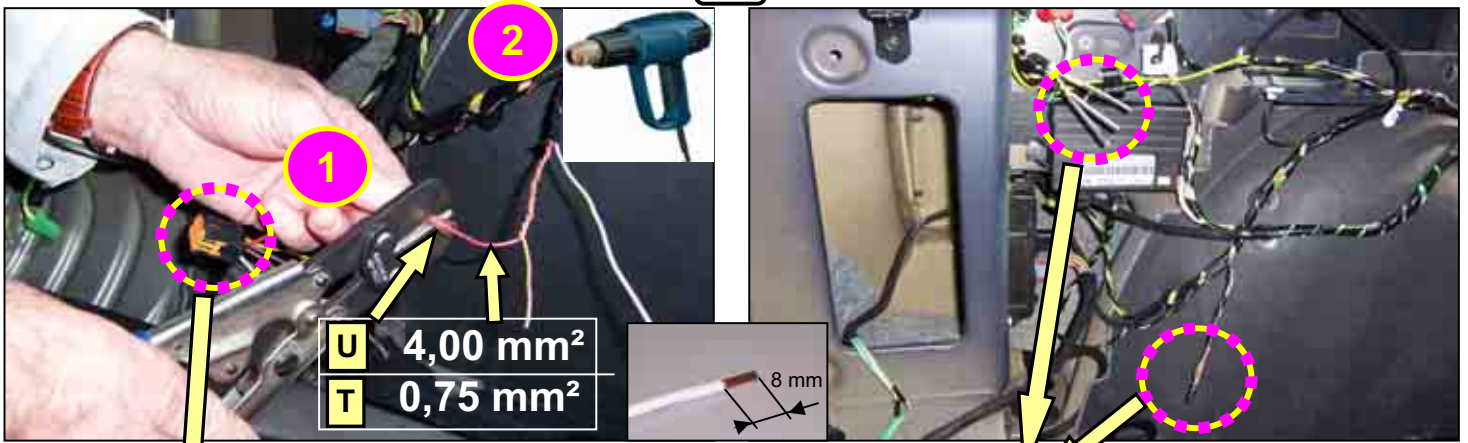

U 4,00 mm²
T 0,75 mm²

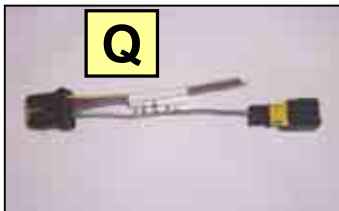
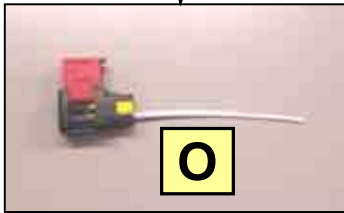
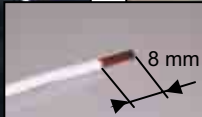

			BF16 : +batt
4,0 mm ²	blanc	F	4,0 mm ²
	white	GB	
	weiss	D	
	bianco	I	
	wit	NL	
	branco	P	
	blanco	E	
			210 : stop info
0,75 mm ²	jaune	F	0,5 mm ²
	yellow	GB	
	gelb	D	
	giallo	I	
	geel	NL	
	amarelo	P	
	amarillo	E	
			Z33 / Z34 : +can
0,75 mm ²	gris	F	0,5 mm ²
	grey	GB	
	grau	D	
	grigio	I	
	grijs	NL	
	cinzento	P	
	gris	E	
			BE08 : +batt BSI
0,75 mm ²	violet	F	0,75 mm ²
	purple	GB	
	violett	D	
	violaceo	I	
	paars	NL	
	violeta	P	
	púrpura	E	
			9017 : can H
0,75 mm ²	rouge	F	0,35 mm ²
	red	GB	
	rot	D	
	rosso	I	
	rood	NL	
	vermelho	P	
	rojo	E	
			9018 : can L
0,75 mm ²	marron	F	0,35 mm ²
	brown	GB	
	braun	D	
	marrone	I	
	bruin	NL	
	castanho	P	
	marron	E	

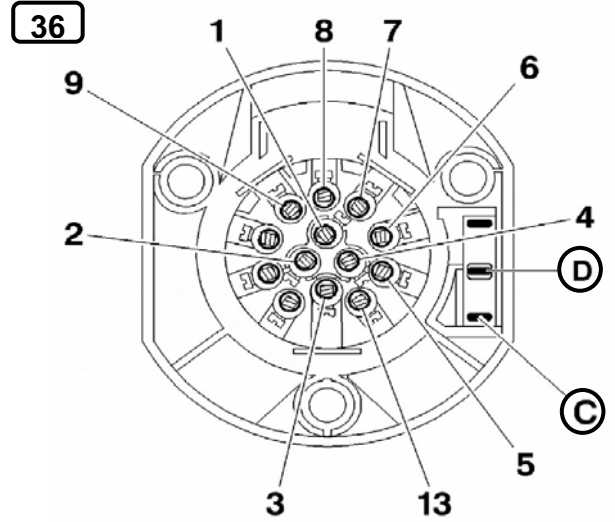
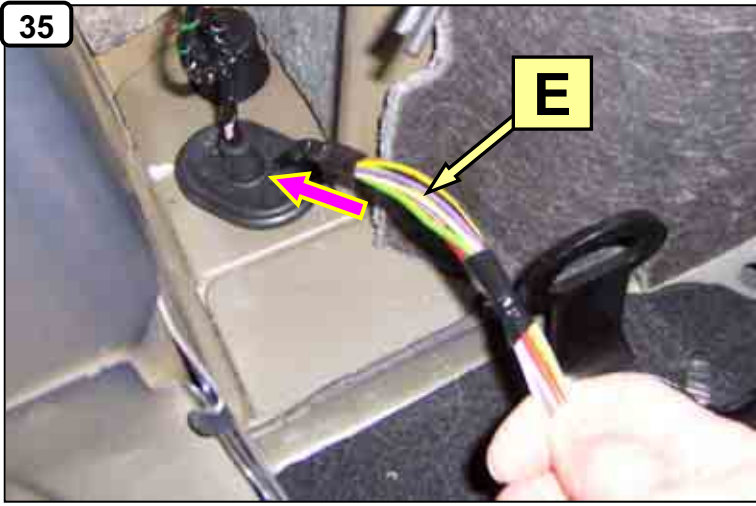

	1 	2 	3 1,5 mm ²	4 	5 	6 	7
F	Jaune	Orange	Vert/jaune	Vert	Beige	Violet	Noir
D	Gelb	Orange	Grün/gelb	Grün	Beige	Violett	Schwarz
GB	Yellow	Orange	Green/yellow	Green	Beige	Purple	Black
NL	Geel	Oranje	Groen/geel	Groen	Beige	Paars	Zwart
P	Amarelo	Cor de laranja	Verde/amarelo	Verde	Beige	Violeta	Preto
I	Giallo	Arancio	Verde/giallo	Verde	Beige	Violacco	Nero
E	Amarillo	Anaranjado	Verde/amarillo	Verde	Beige	Púrpura	Negro

	8 	9 +BATT	10 +	11 2,5 mm ²	13 1,5 mm ²	C	D
F	Blanc	Rouge	Marron	Vert/jaune	Vert/jaune	Gris	Rose
D	Weiß	Rot	Braun	Grün/gelb	Grün/gelb	Grau	Rosa
GB	White	Red	Brown	Green/yellow	Green/yellow	Grey	Pink
NL	Wit	Rood	Bruin	Groen/geel	Groen/geel	Grijs	Roze
P	Branco	Vermelho	Castanho	Verde/amarelo	Verde/amarelo	Cinzeno	Cor de rosa
I	Bianco	Rosso	Marrone	Verde/giallo	Verde/giallo	Grigio	Rosa
E	Blanco	Rojo	Marron	Verde/amarillo	Verde/amarillo	Gris	Rosa

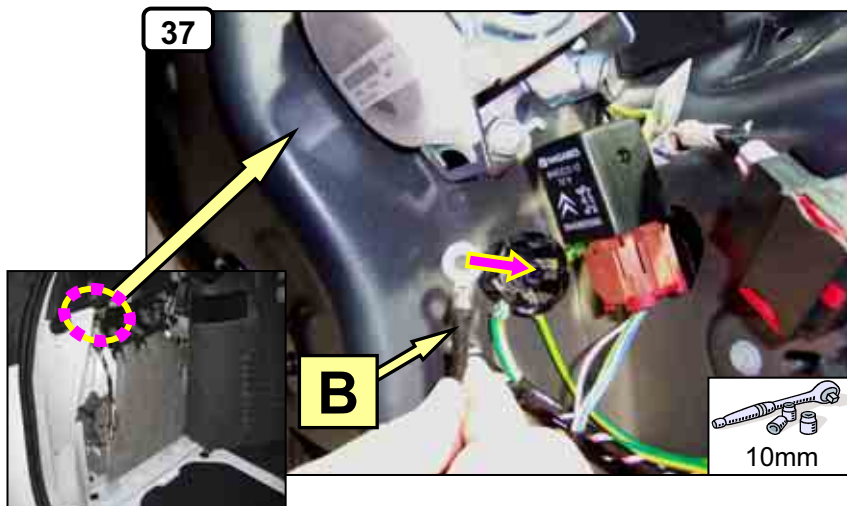

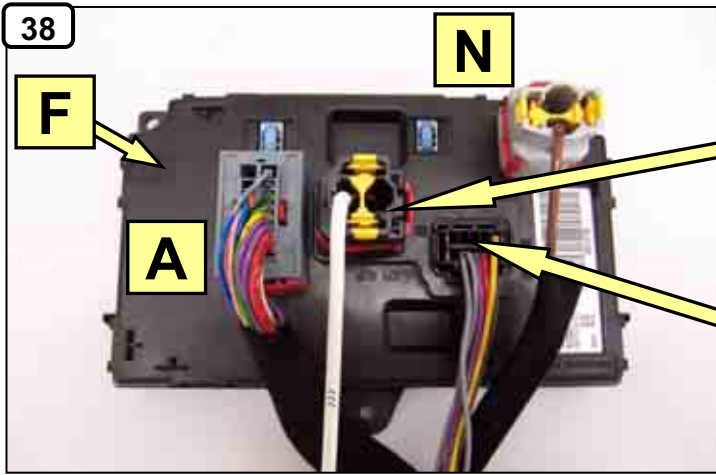

O

ØR → | 11557

AA2

ØR 11558 | → 12530

Q

ØR → | 11557

AA1

ØR 11558 | → 12530

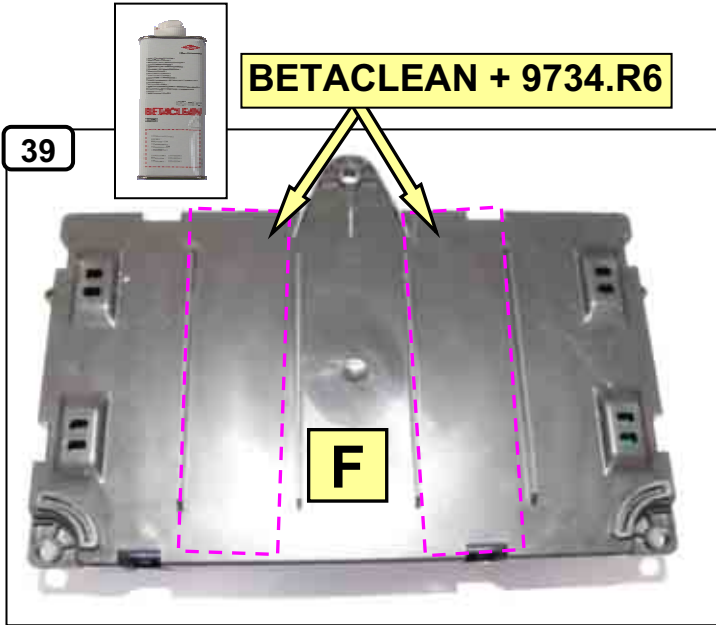

BETACLEAN + 9734.R6

F

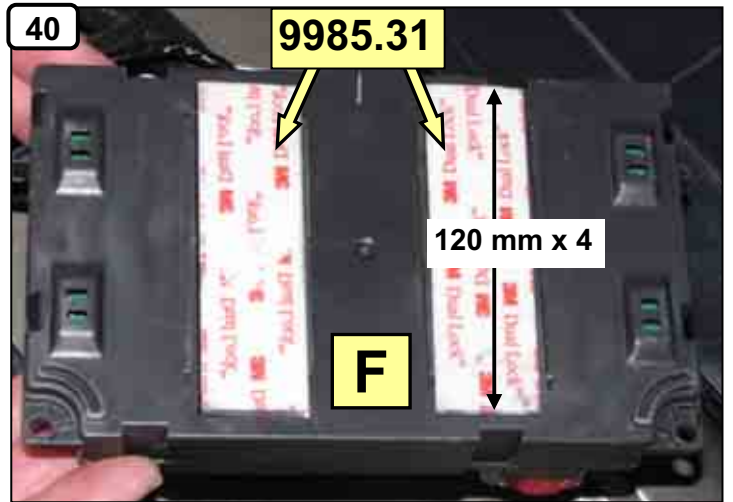

9985.31

120 mm x 4

F



BETACLEAN

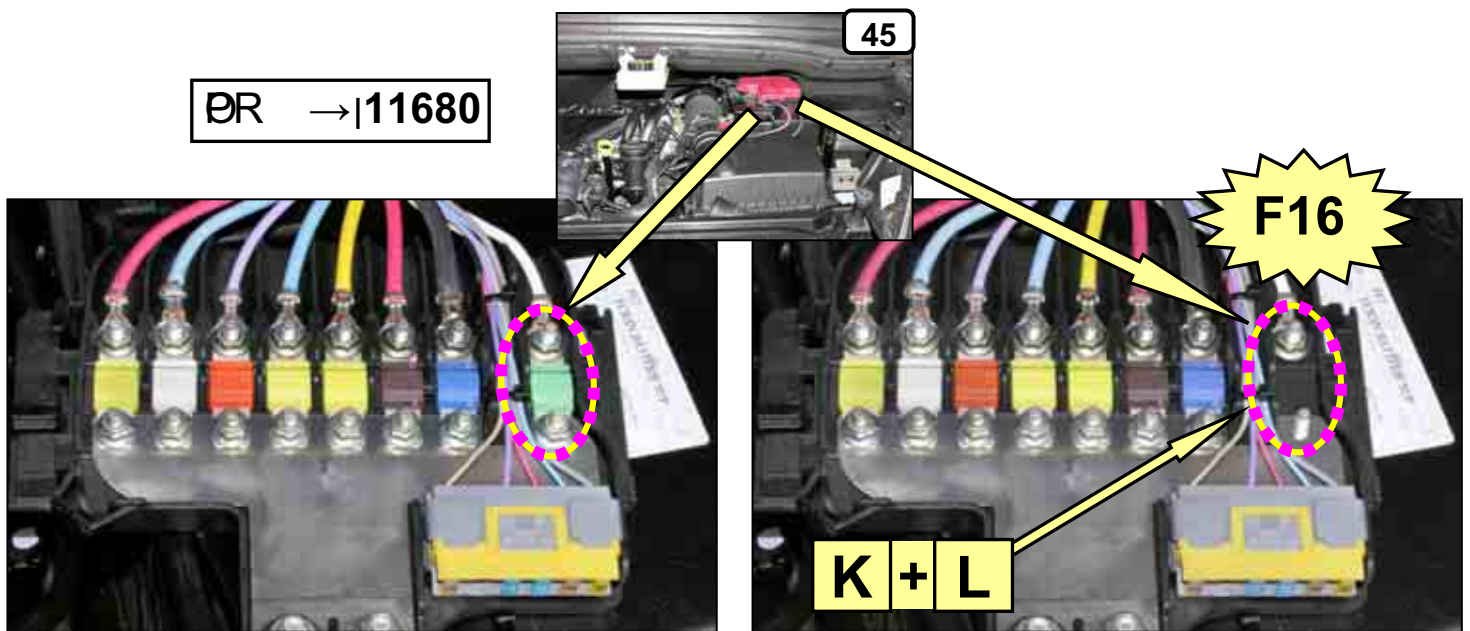
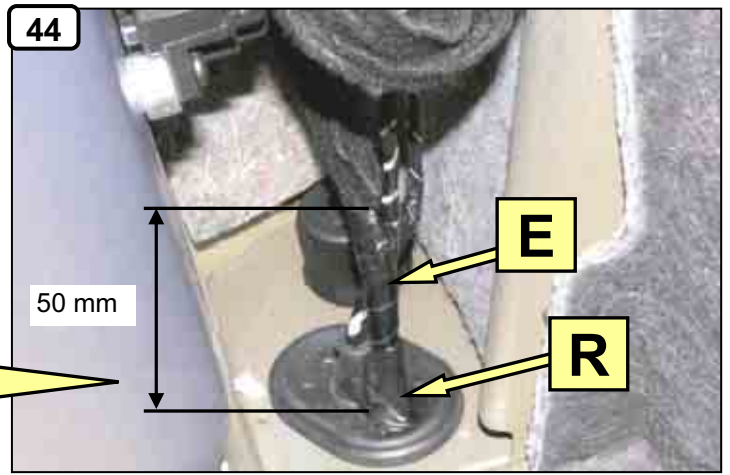
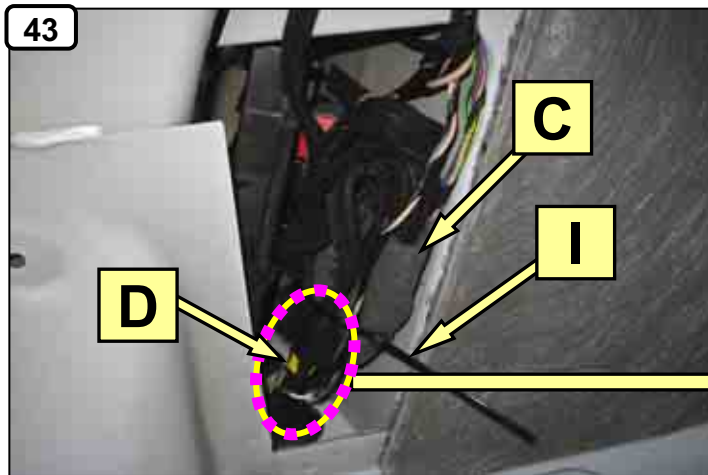
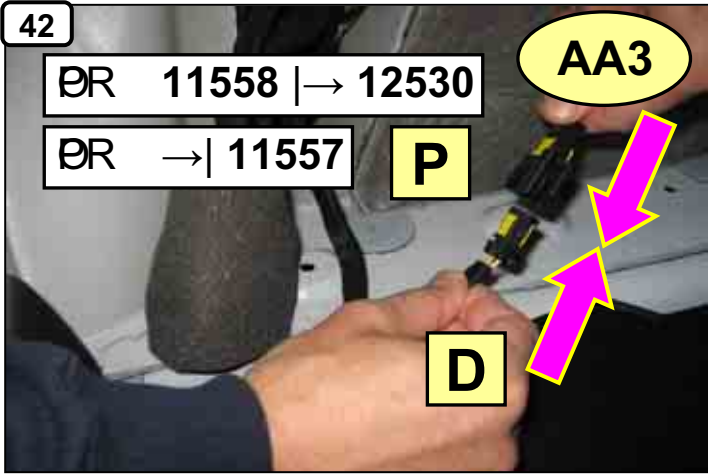

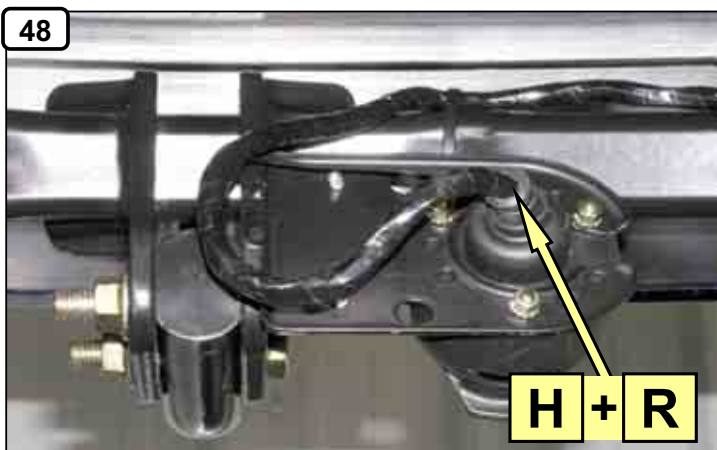
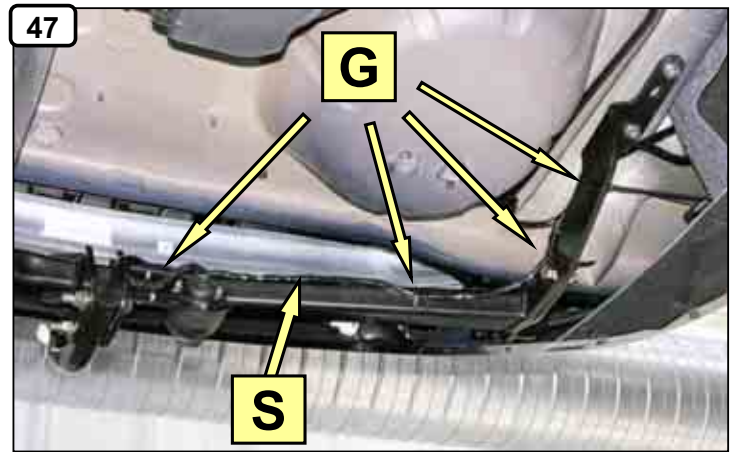
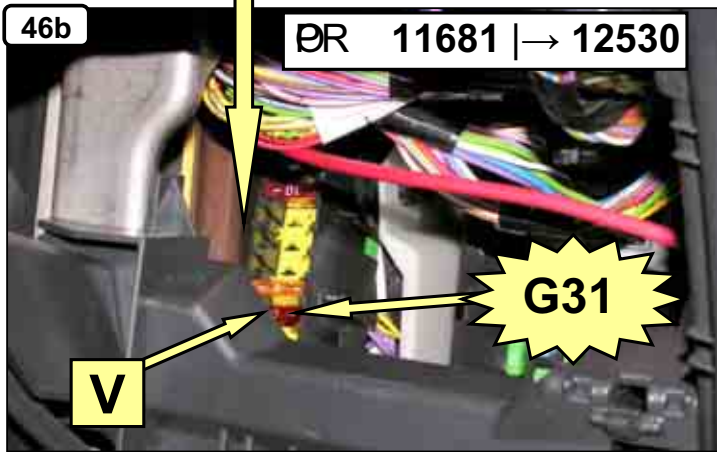
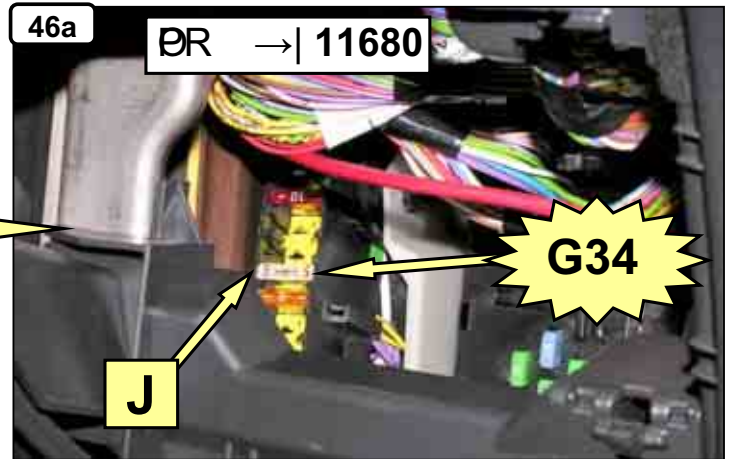



- à l'aide de l'outil diagnostique Citroen :
 déclarer la présence du boitier de servitude remorque dans le menu équipement
 - vérifier l'absence de tout code défaut
- by means of the diagnostic tool Citroen :
 to declare the presence of the trailer control module in the menu equipment
 - verify the absence of any code defect
- Mit Hilfe vom diagnostischen Werkzeug Citroen :
 die Anwesenheit Boitier der Knechtschaft zu erklären schleppt im Menü Ausrüstung ab
 - zu prüfen dass kein Funktionsfehlercode vorliegt
- con la herramienta diagnóstico Citroen :
 declarar la presencia del BSR (caja servicio remolque) en el menu equipamiento
 - comprobar que no hay ningún código de fallo
- ha l'aiuto dell'attrezzo diagnostico Citroën :
 dichiarare la presenza della BSR (scatola servitù rimorchio) nella menu apparecchiature
 - verificare l'assenza di ogni codice difetto
- met behulp van het diagnostische werktuig Citroen :
 verklaren de aanwezigheid van BSR (processor aanhanwagenorganen) in menu uitrusting
 - controleren of het ontbreken van een code gebrek
- använda diagnosverktyg Citroen :
 förklara närvaron av BSR (anslutningslada för släp) i menu utrustning
 - kontrollera att det inte finns några dubbelbeskattningsavtal
- utilizando a ferramenta de diagnóstico Citroen :
 declarar a presença do BSR (caixa bondage trailer) no menu equipamentos
 - verifique a ausência de qualquer defeito de código

OPR 12531 |→

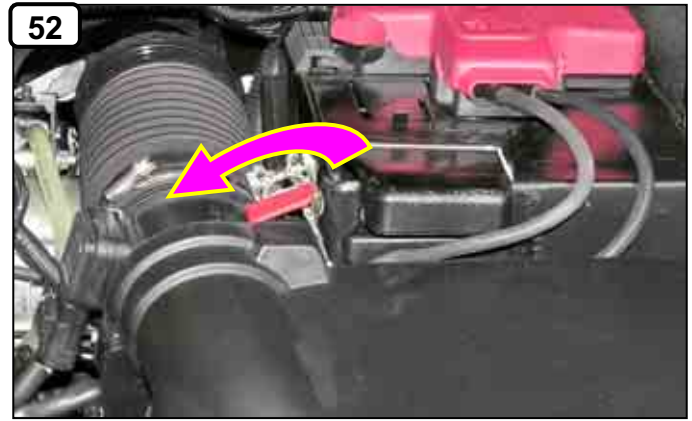
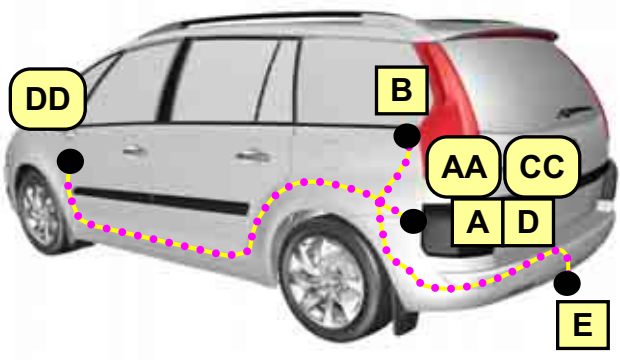

53 → 65



66 → 82

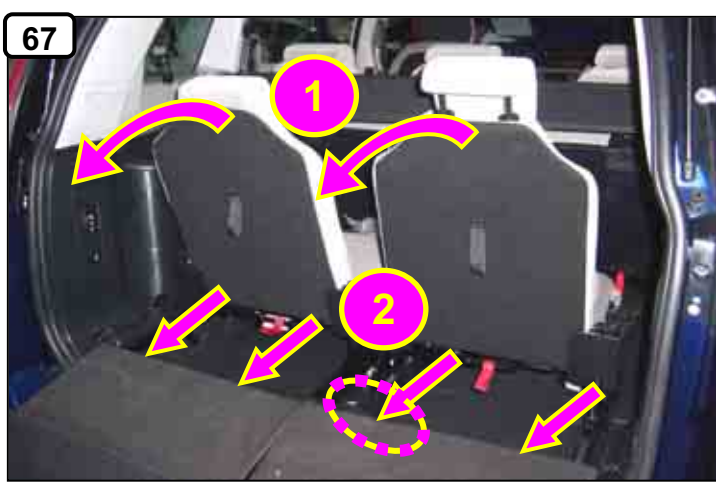



53



65



66



82

55

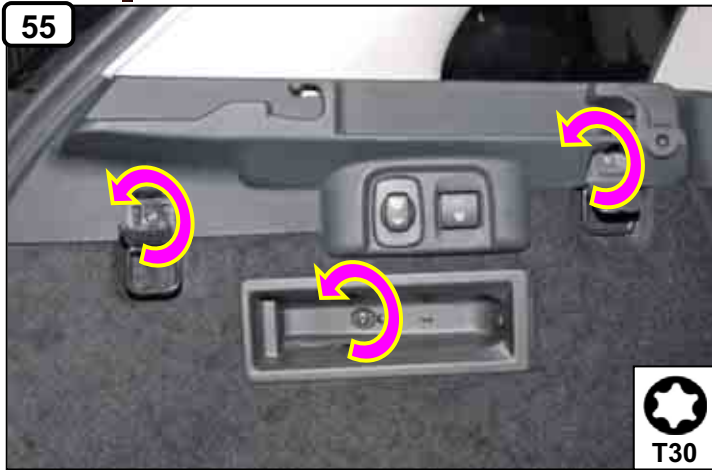

68



56



69



57

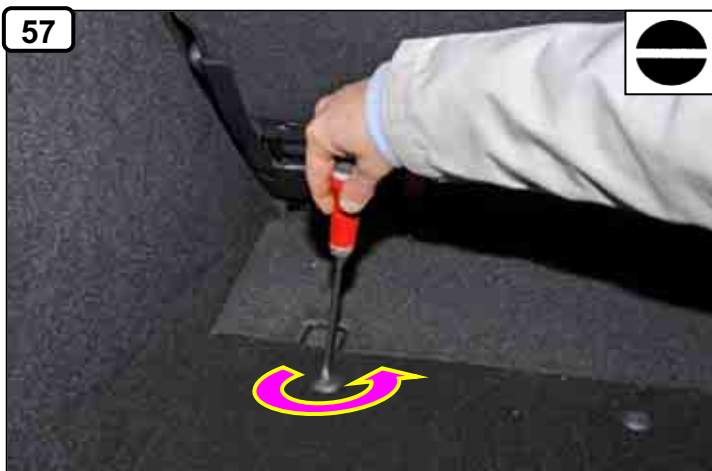

70



58

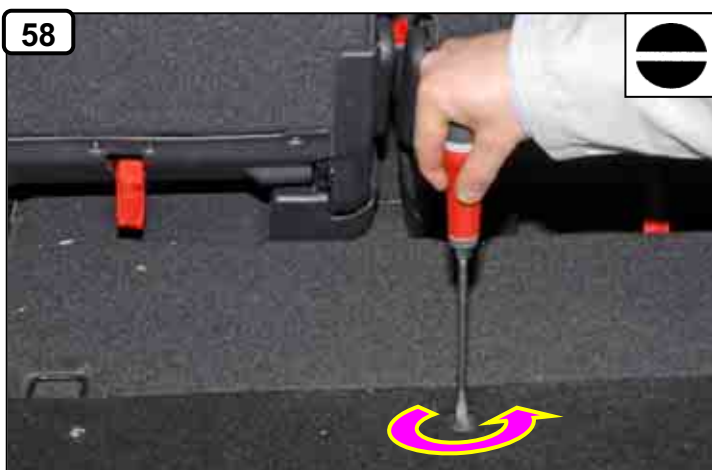

71





53



65



66



82

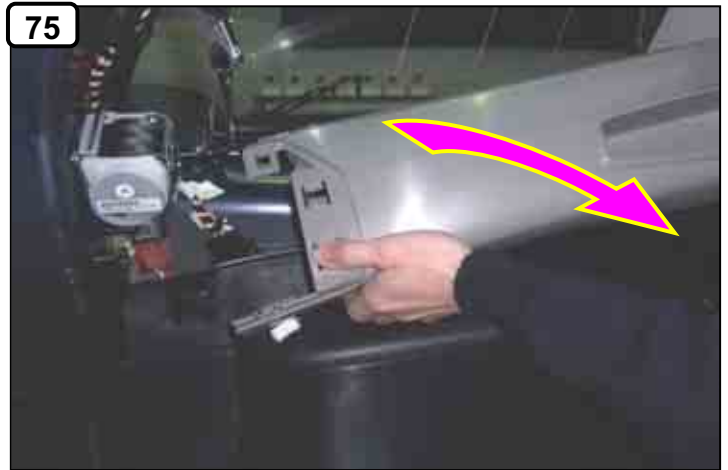



53



65



66



82

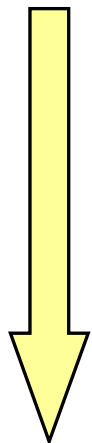
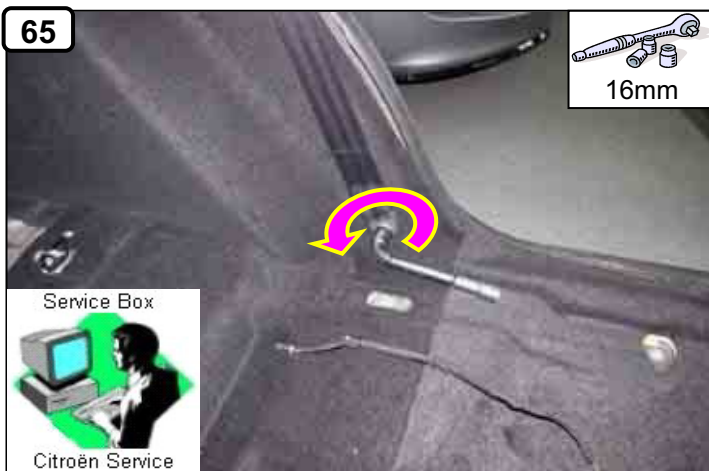
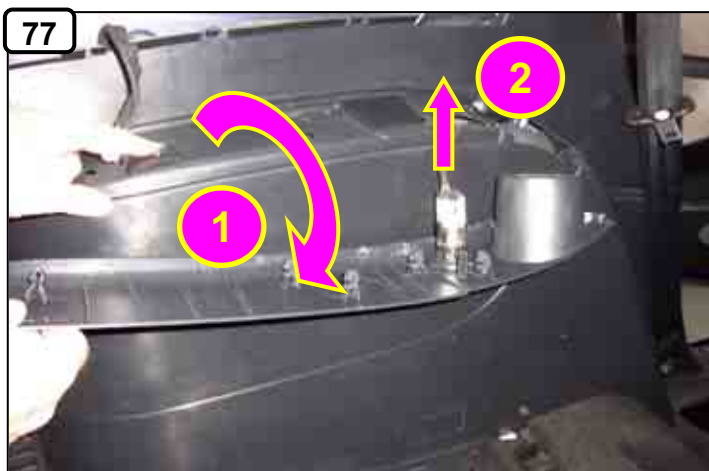



66



82

80



81

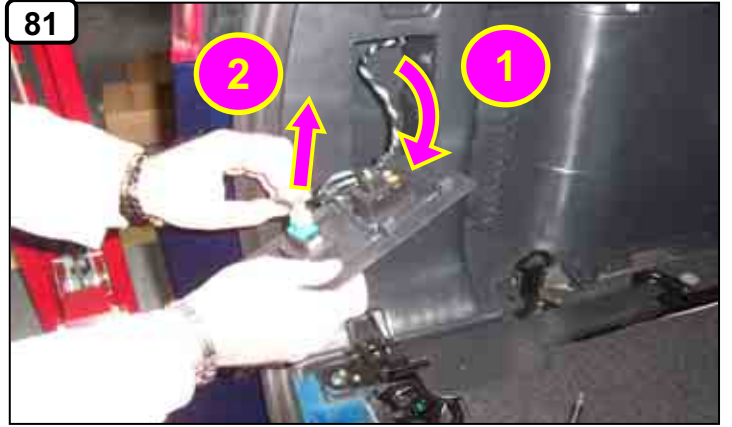

82



84



85



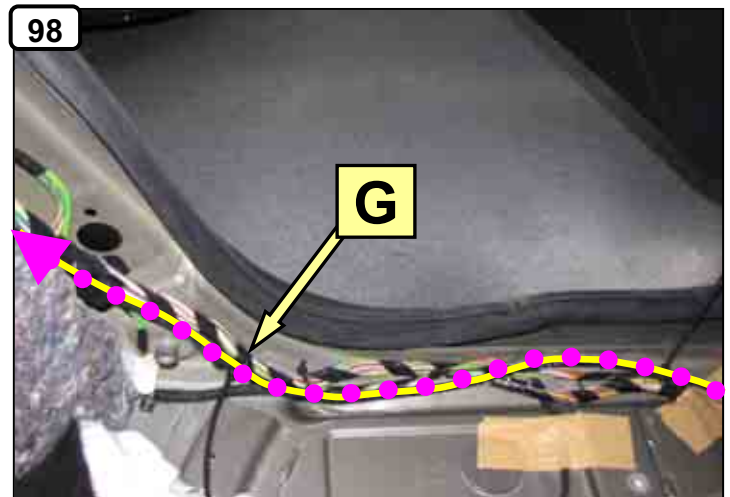
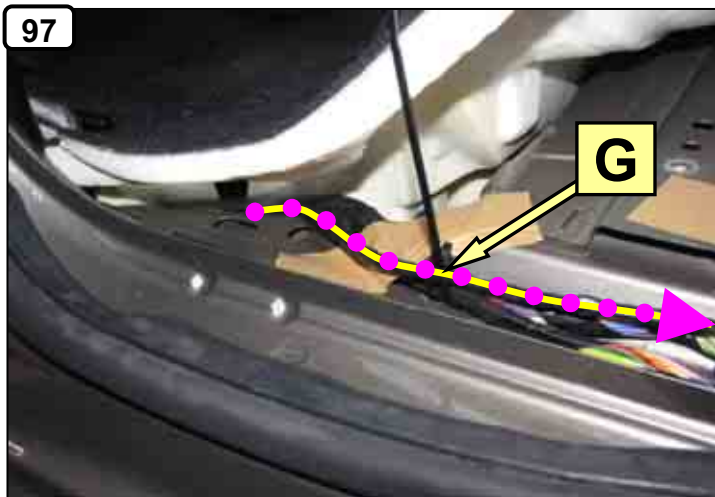
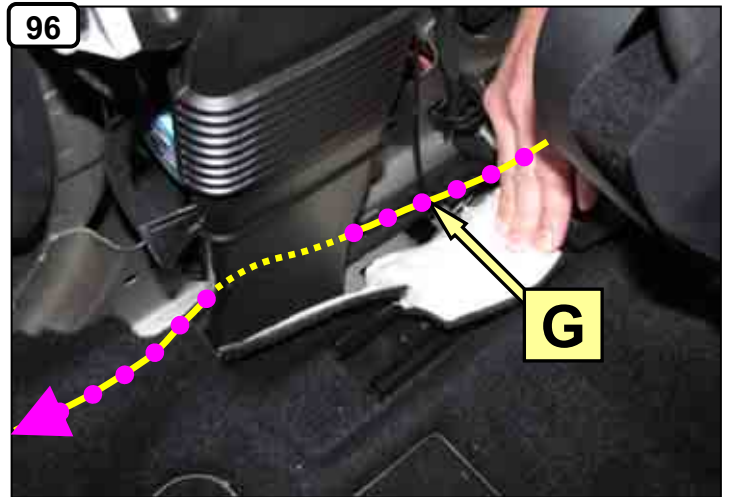
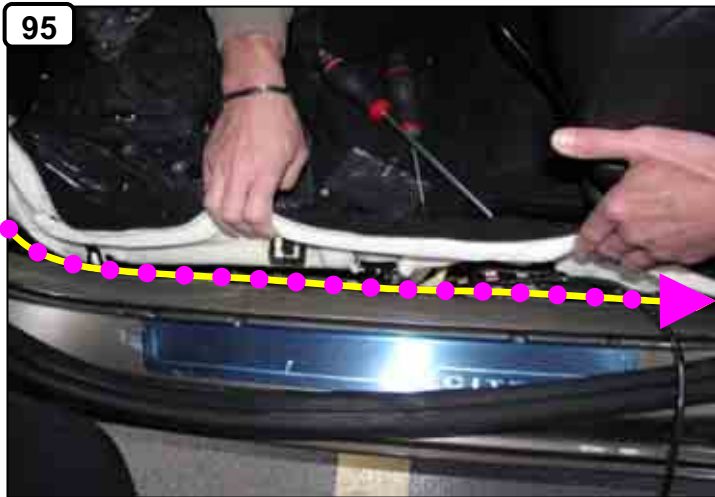
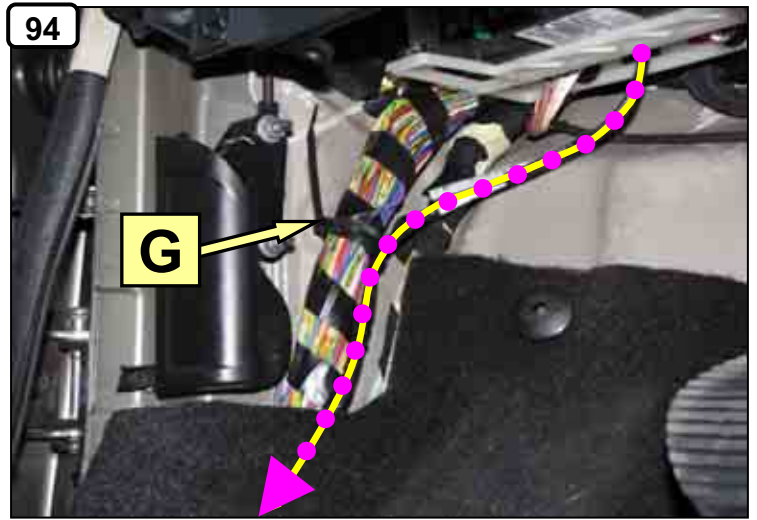
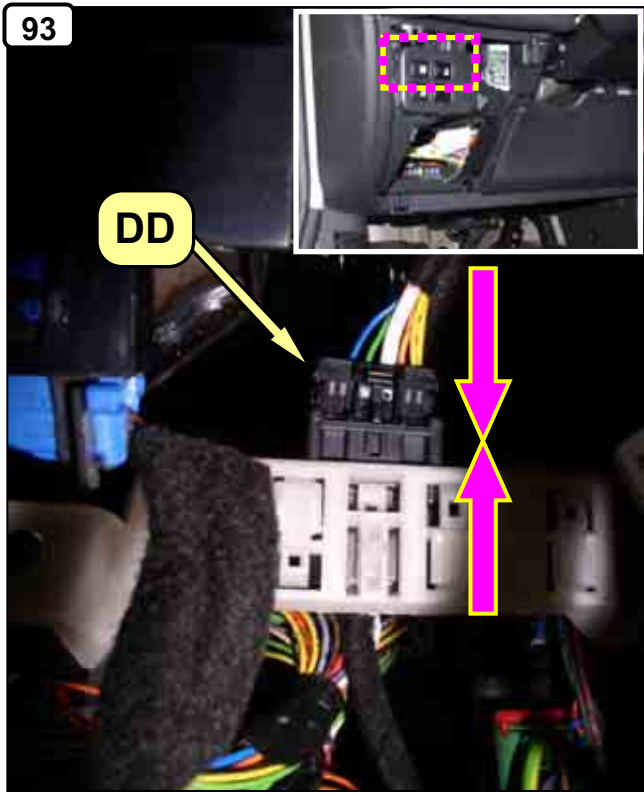

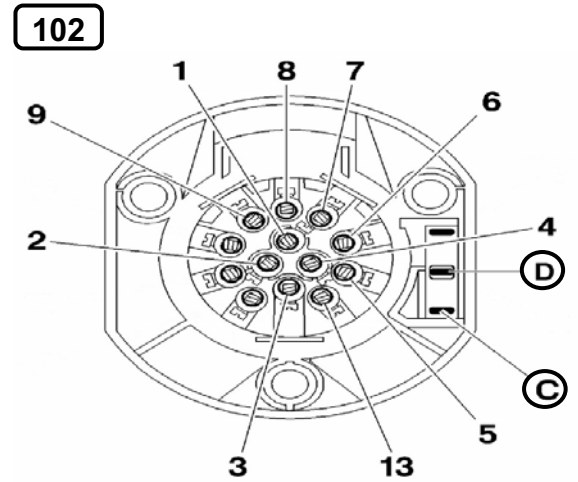
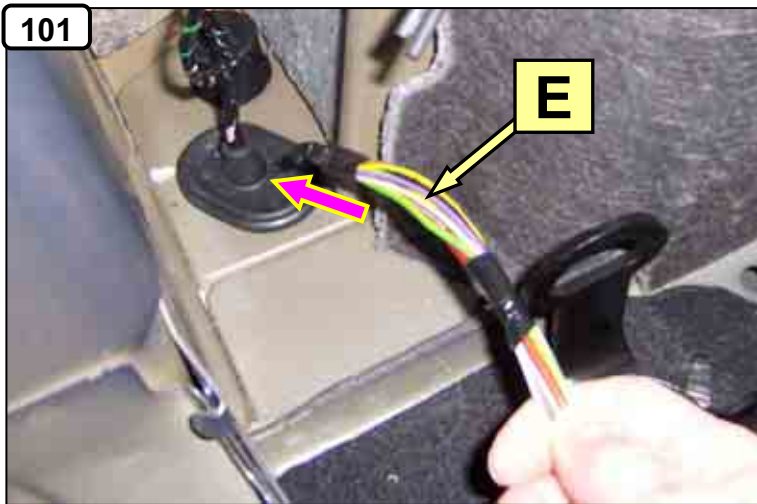

	1 	2 	3 1,5 mm ²	4 	5 	6 	7
(F)	Jaune	Orange	Vert/jaune	Vert	Beige	Violet	Noir
(D)	Gelb	Orange	Grün/gelb	Grün	Beige	Violett	Schwarz
(GB)	Yellow	Orange	Green/yellow	Green	Beige	Purple	Black
(NL)	Geel	Oranje	Groen/geel	Groen	Beige	Paars	Zwart
(P)	Amarelo	Cor de laranja	Verde/amarelo	Verde	Beige	Violeta	Preto
(I)	Giallo	Arancio	Verde/giallo	Verde	Beige	Viola	Nero
(E)	Amarillo	Anaranjado	Verde/amarillo	Verde	Beige	Púrpura	Negro

	8 	9 +BATT	10 +	11 2,5 mm ²	13 1,5 mm ²	(C)	(D)
(F)	Blanc	Rouge	Marron	Vert/jaune	Vert/jaune	Gris	Rose
(D)	Weiß	Rot	Braun	Grün/gelb	Grün/gelb	Grau	Rosa
(GB)	White	Red	Brown	Green/yellow	Green/yellow	Grey	Pink
(NL)	Wit	Rood	Bruin	Groen/geel	Groen/geel	Grijs	Roze
(P)	Branco	Vermelho	Castanho	Verde/amarelo	Verde/amarelo	Cinzent	Cor de rosa
(I)	Bianco	Rosso	Marrone	Verde/giallo	Verde/giallo	Grigio	Rosa
(E)	Blanco	Rojo	Marron	Verde/amarillo	Verde/amarillo	Gris	Rosa

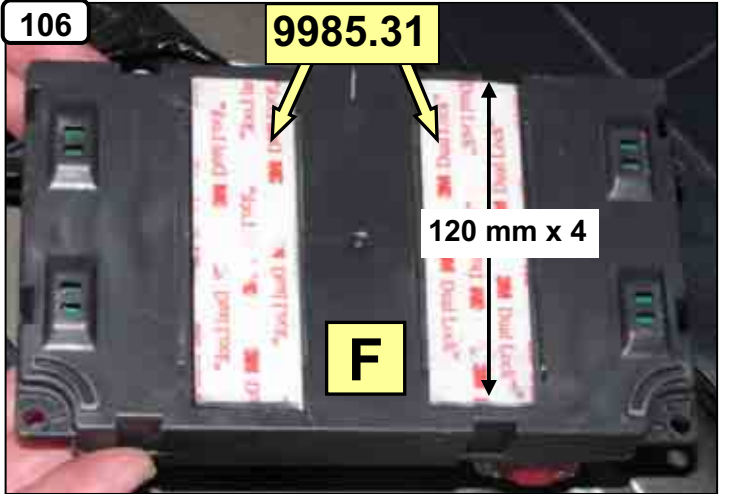
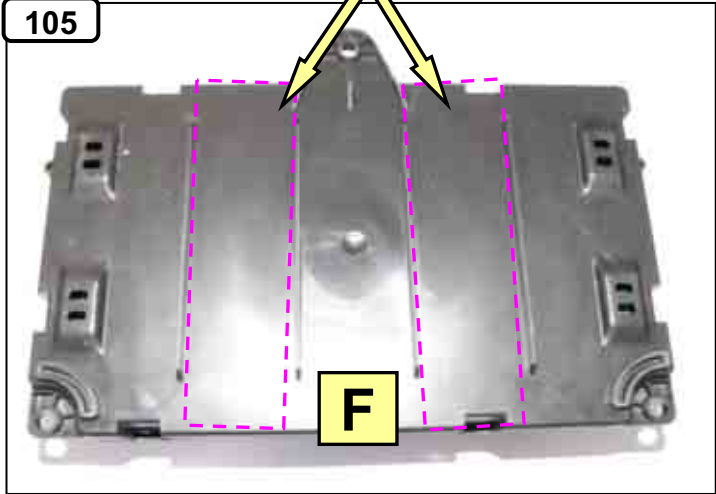
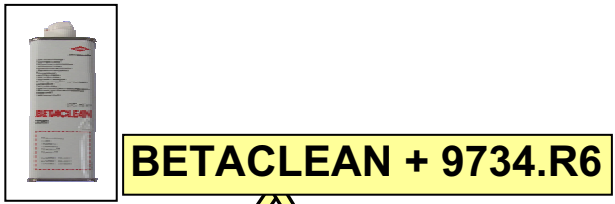
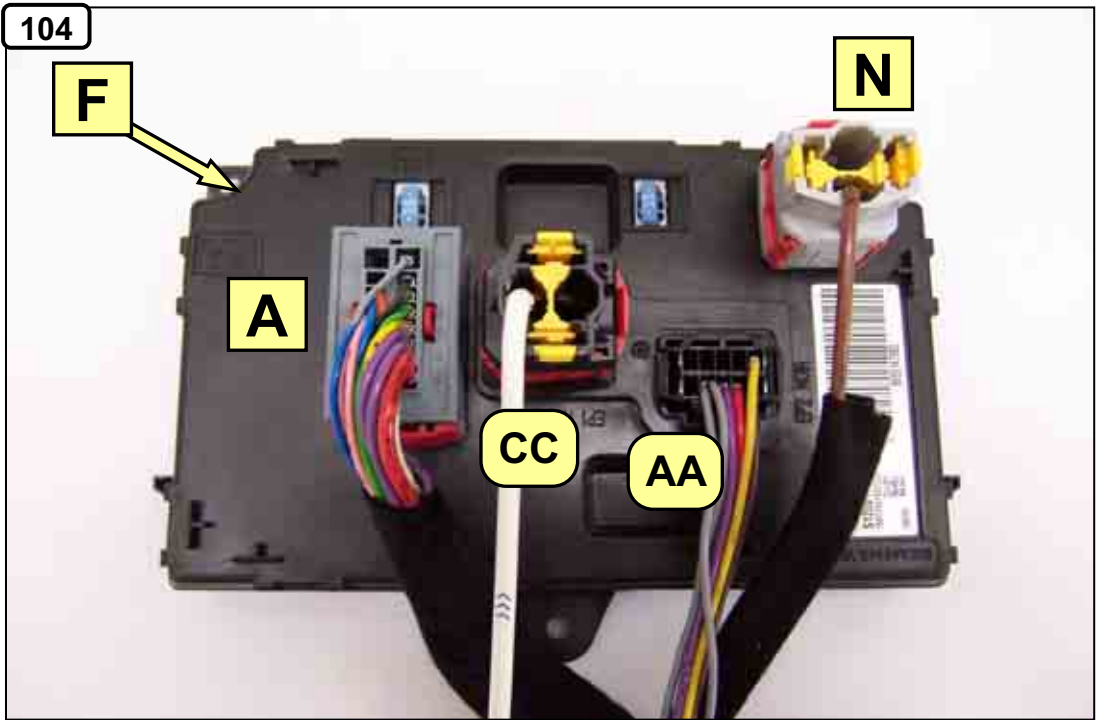
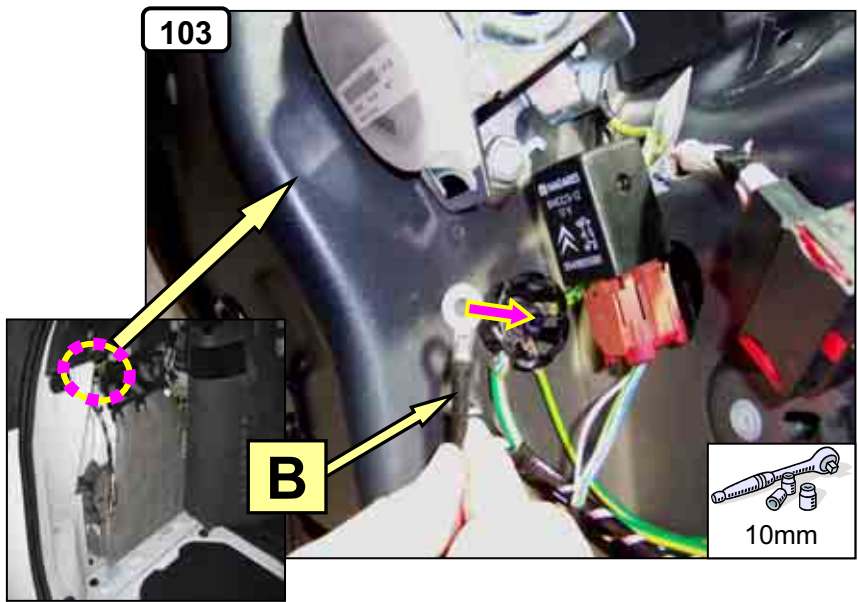

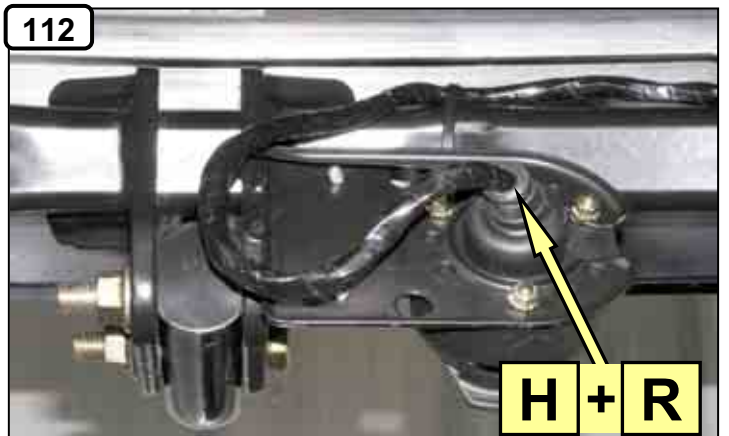
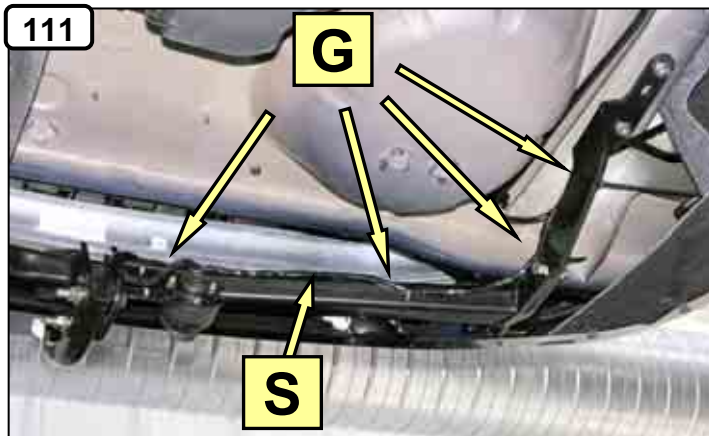
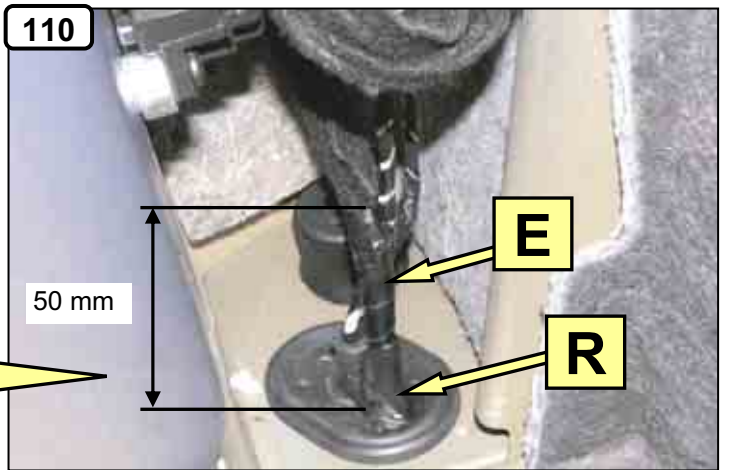
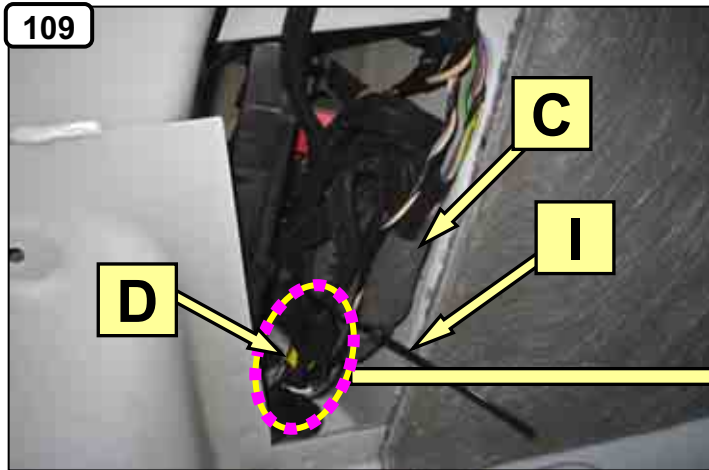
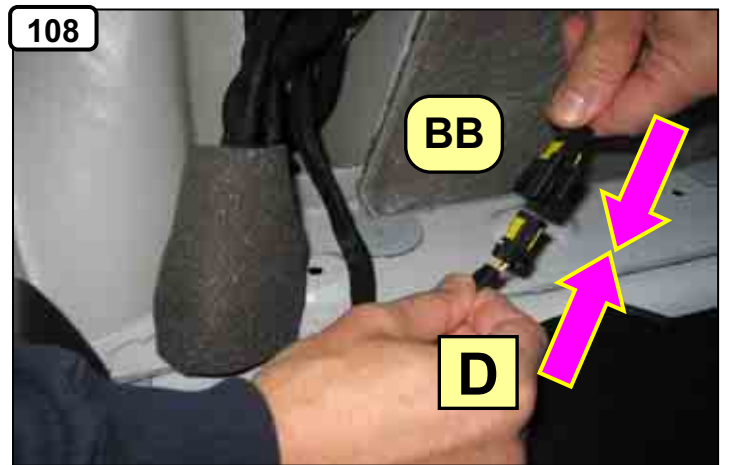

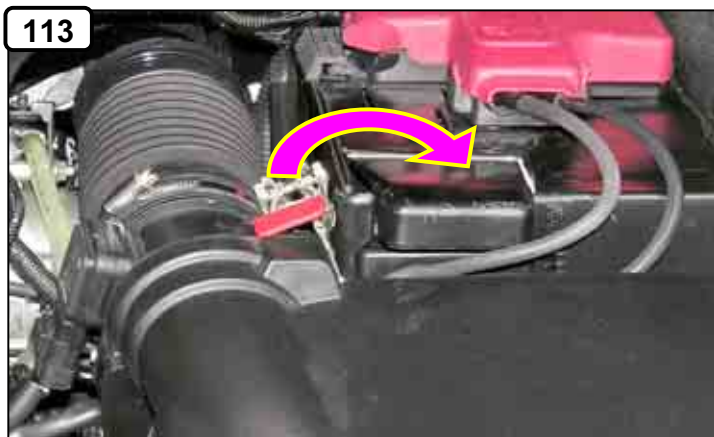

- F** : Aide au stationnement
- D** : Einparkhilfe
- GB** : Parking assistance
- NL** : Parkeerhulp
- P** : Auxílio ao estacionamento
- I** : Aiuto in parcheggio
- E** : Ayuda en estacionamiento



- à l'aide de l'outil diagnostique Citroen :
déclarer la présence du boîtier de servitude remorque dans le menu équipement
- vérifier l'absence de tout code défaut

- by means of the diagnostic tool Citroen :
to declare the presence of the trailer control module in the menu equipment
- verify the absence of any code defect

- Mit Hilfe vom diagnostischen Werkzeug Citroen :
die Anwesenheit Boitier der Knechtschaft zu erklären schleppt im Menü Ausrüstung ab
- zu prüfen dass kein Funktionsfehlercode vorliegt

- con la herramienta diagnóstico Citroen :
declarar la presencia del BSR (caja servicio remolque) en el menu equipamiento
- comprobar que no hay ningún código de fallo

- ha l'aiuto dell'attrezzo diagnostico Citroën :
dichiarare la presenza della BSR (scatola servitù rimorchio) nella menu apparecchiature
- verificare l'assenza di ogni codice difetto

- met behulp van het diagnostische werktuig Citroen :
verklaren de aanwezigheid van BSR (processor aanhanwagenorganen) in menu uitrusting
- controleren of het ontbreken van een code gebrek

- använda diagnosverktyg Citroen :
förklara närvaron av BSR (anslutningslada för släp) i menu utrustning
- kontrollera att det inte finns några dubbelbeskattningsavtal

- utilizando a ferramenta de diagnóstico Citroen :
declarar a presença do BSR (caixa bondage trailer) no menu equipamentos
- verifique a ausência de qualquer defeito de código