



AIDE AU STATIONNEMENT AVANT 4 CAPTEURS

Réf.: 9690.01

L'INSTALLATION DOIT ÊTRE ASSURÉE PAR UN PROFESSIONNEL
THE EQUIPEMENT MUST BE INSTALLED BY A QUALIFIED TECHNICIAN
L'INSTALLAZIONE DEVE ESSERE ESEGUITA DA UN TECNICO QUALIFICATO
DIE INSTALLATION MUß DURCH EINEN QUALIFIZIERTEN TECHNIKER VERGENOMMEN WERDEN
DE INSTALLATIE MOET DOOR EEN GEKWALIFICEERD TECHNICUS WORDEN UITGEVOERD
A INSTALAÇÃO DEVE SER FEITA POR UM TÉCNICO COMPETENTE
LA INSTALACION DEBE SER REALIZADA POR UN TÉCNICO CUALIFICADO
INSTALACJA MUSI BYC WYKONANA PRZEZ WYKWALIFIKOWANEGO TECHNIKA



INDEX

C1 (B0R).....	Page 3
C3 Picasso (A58).....	Page 9
C3 (A51).....	Page 19
C4 Berline & Coupé (B5A) I-> O 11558.....	Page 28
C4 Picasso (B585).....	Page 37
Grand C4 Picasso (B587).....	Page 46
C5 III berline / C5 III Tourer.....	Page 55
C-CROSSER.....	Page 65
DS3 (A55).....	Page 73
Nemo 5p. (VP).....	Page 82
Berlingo III (B9 VU / B9 VP).....	Page 91

C1 (B0R)



2,00h

1

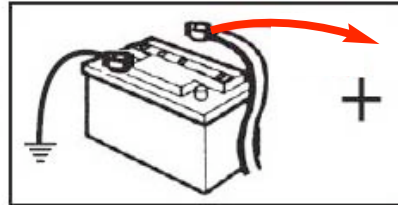

2



3

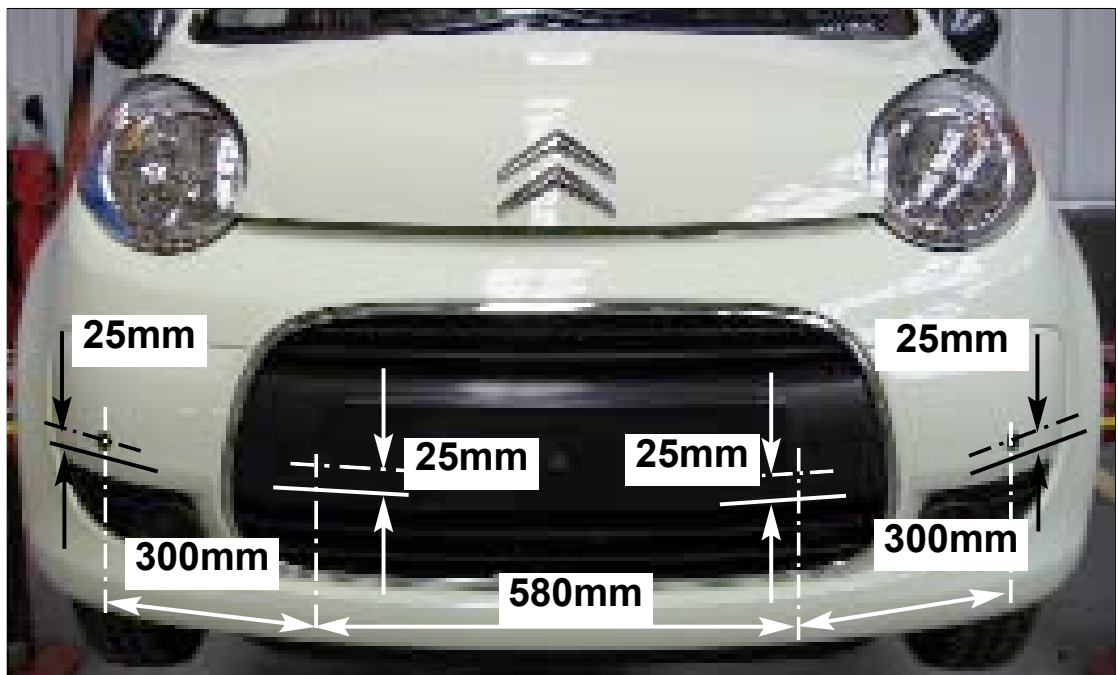

4

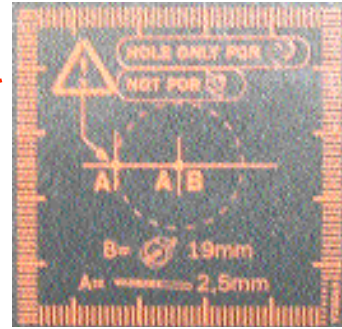
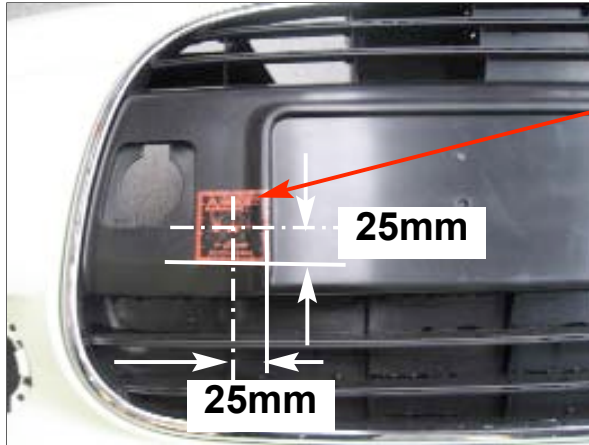

5

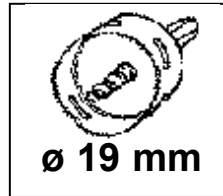
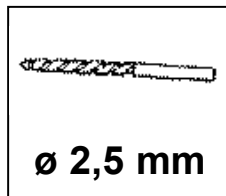
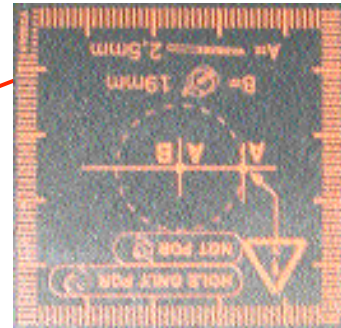
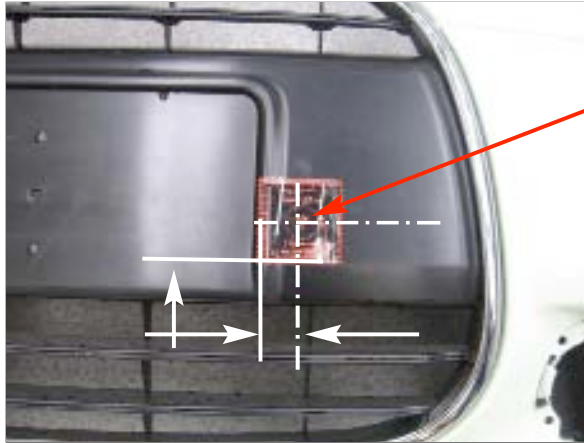

6

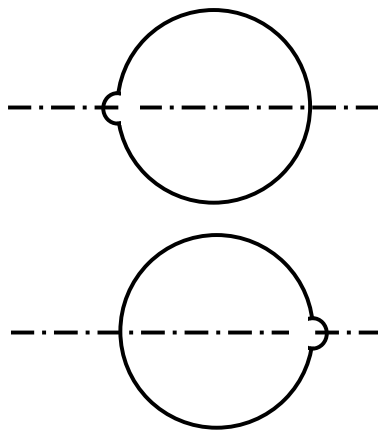

7

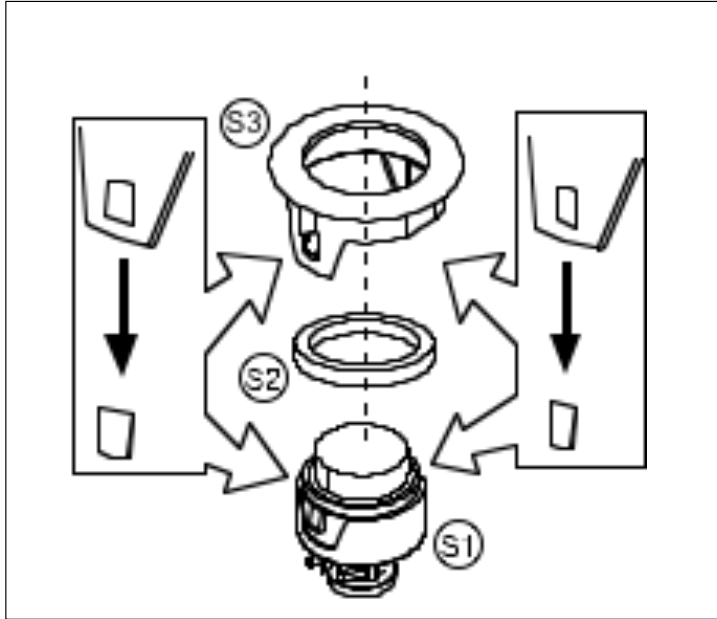

4x

S

8

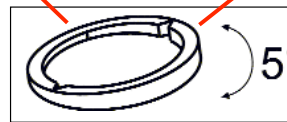
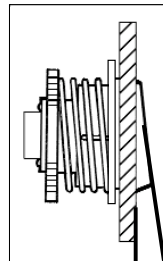

4x

D

5°



11

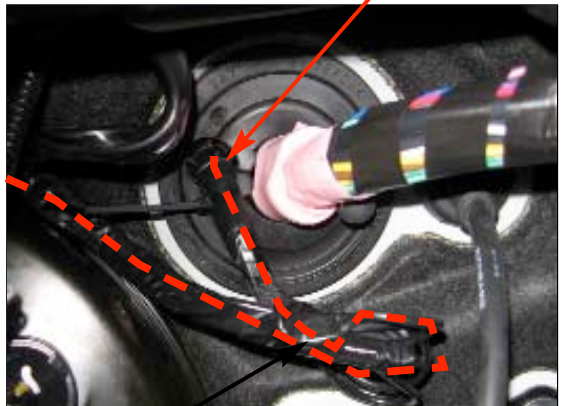
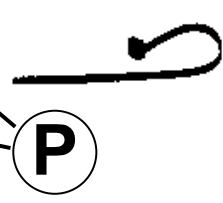
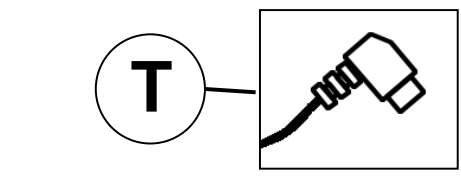

12

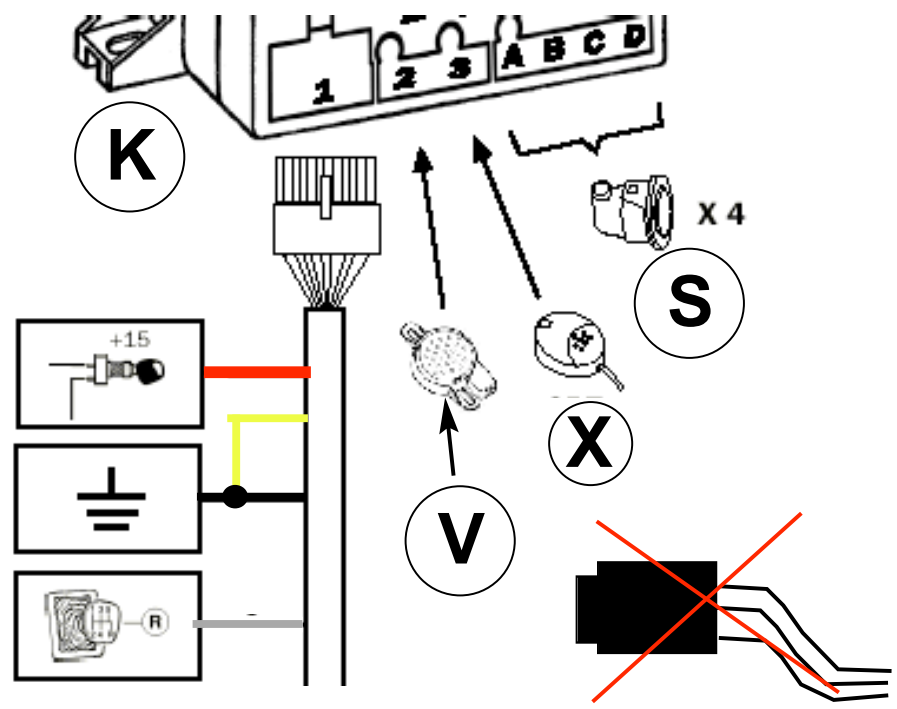

13

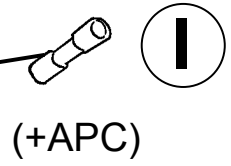
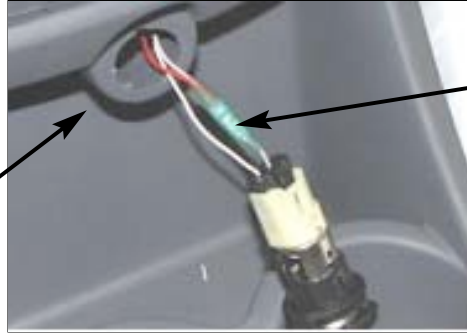

14

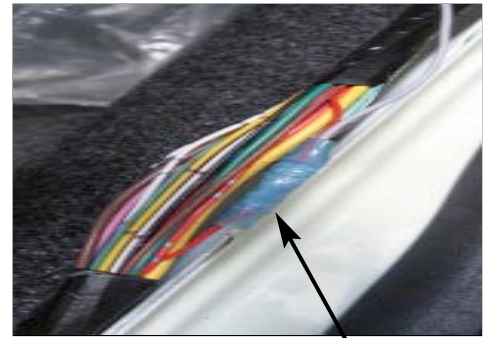

TEST > 12,5V

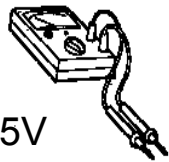

TEST > 12,5V

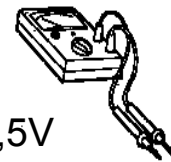

15



16

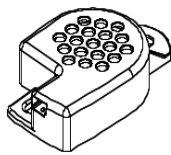
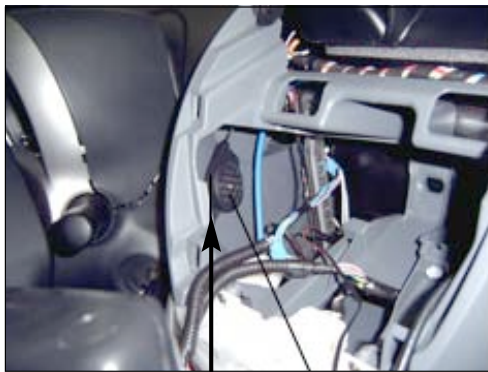

V

+

F

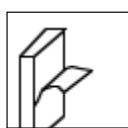

X



17

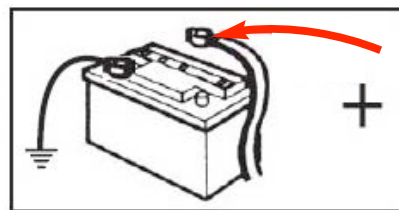

OFF-SET

VOL.

SENS.

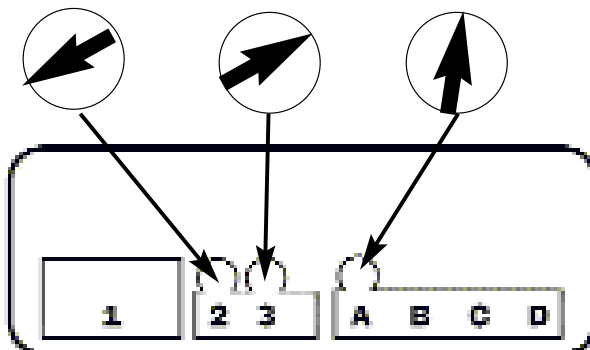

C3 Picasso (A58)



2,10h

1

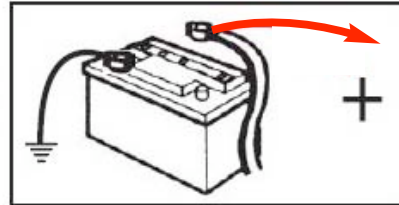

2

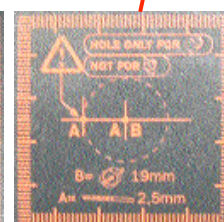
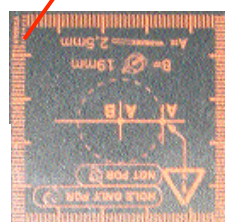
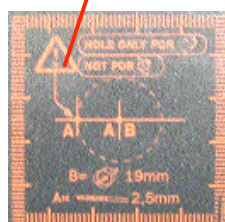
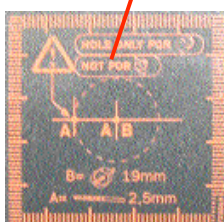
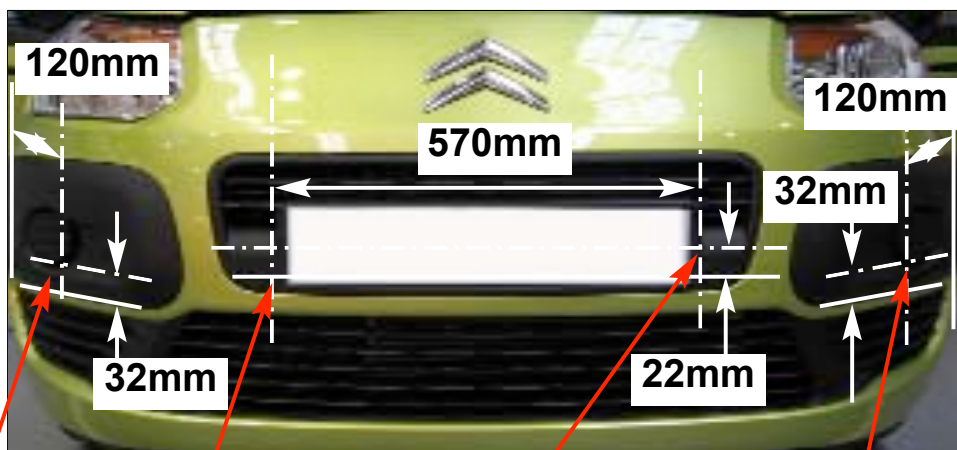

3

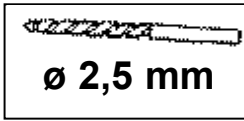
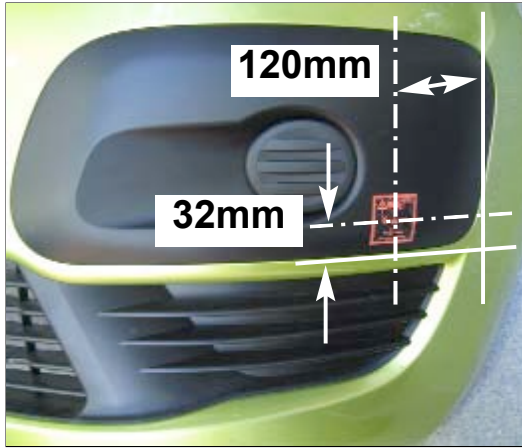

ø 2,5 mm

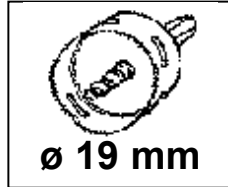

ø 19 mm



4x

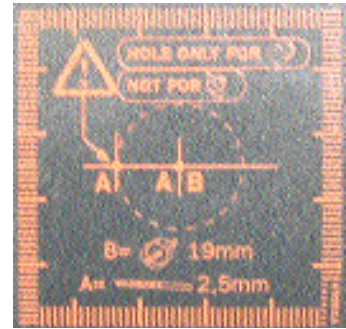
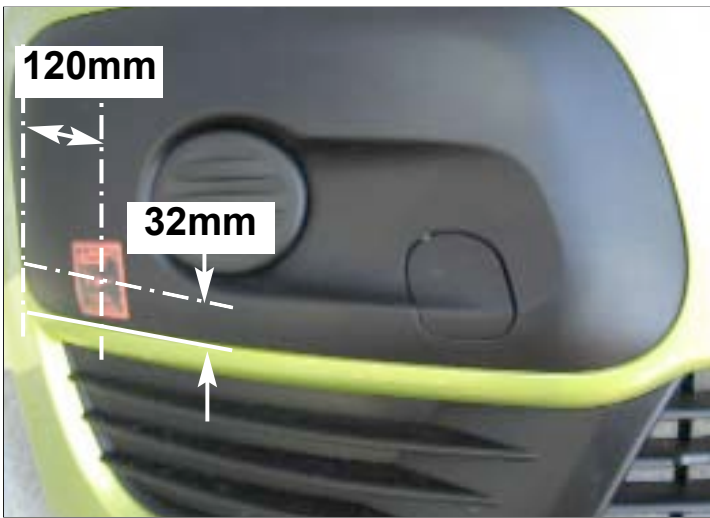

4

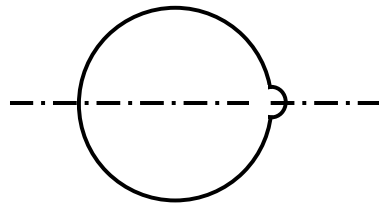
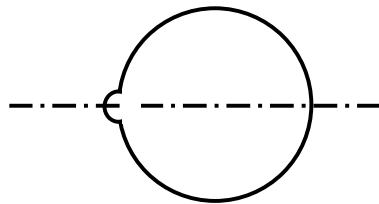

5

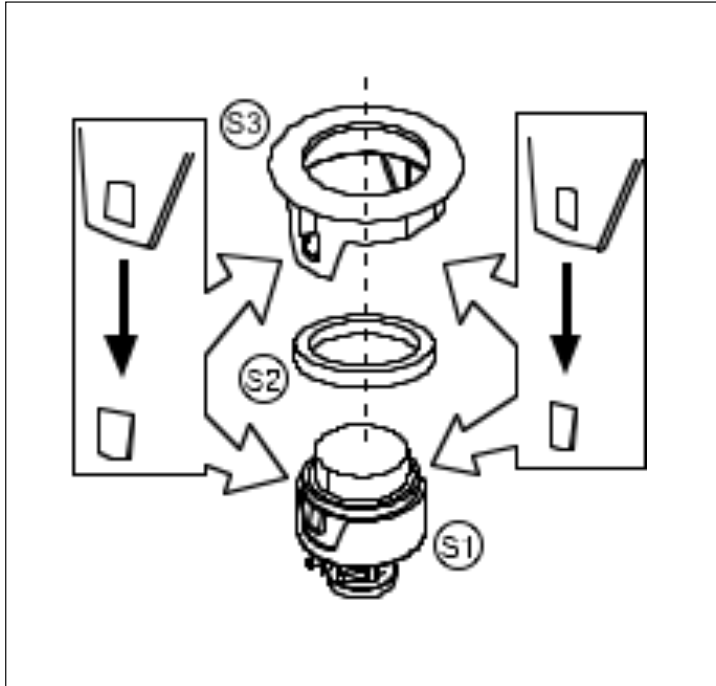

4x

S

6

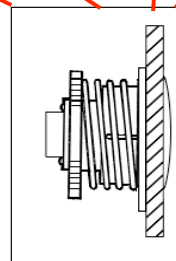
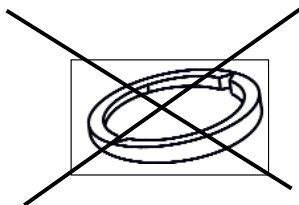

7

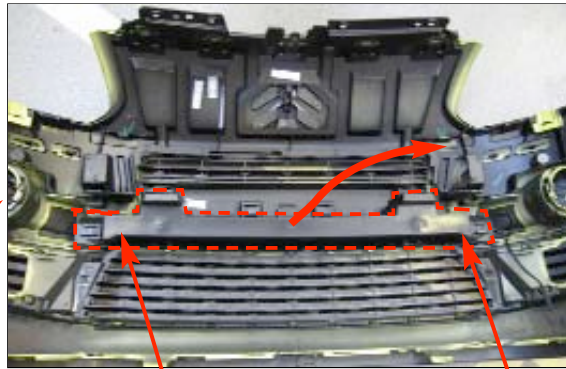

8



4x

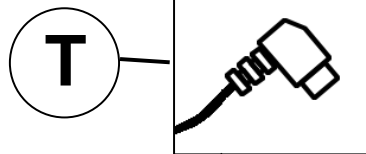

9

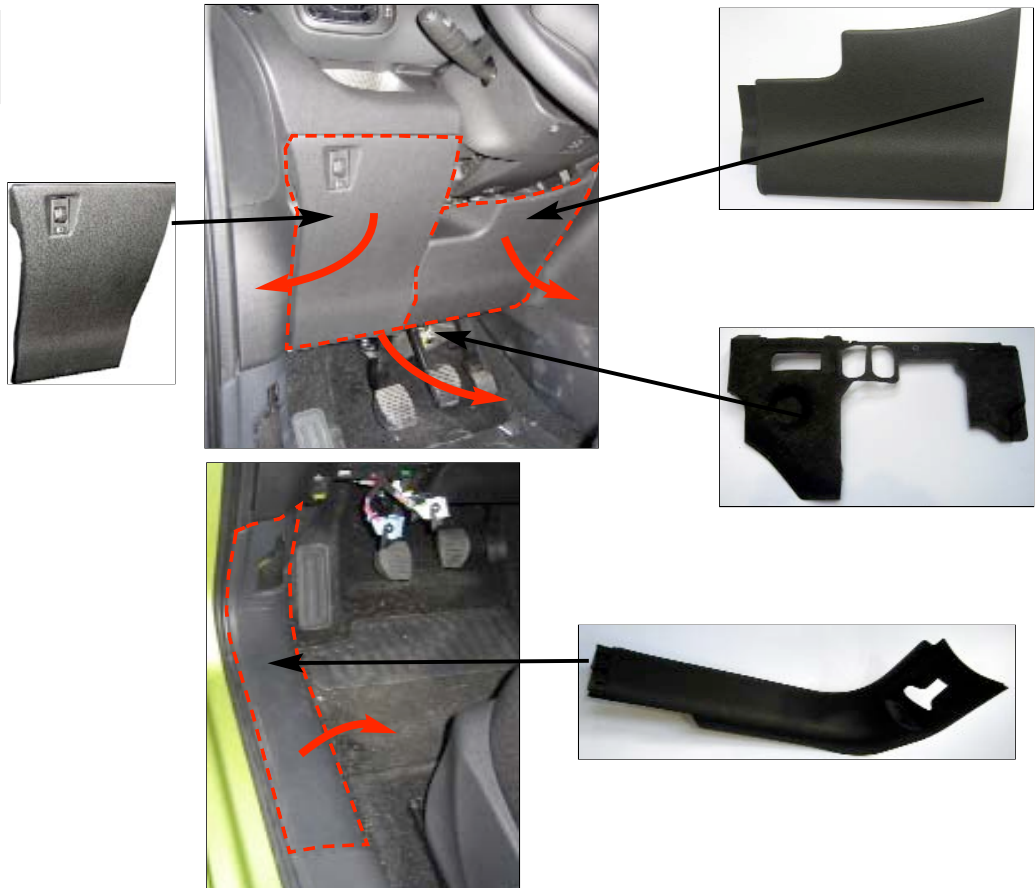

10

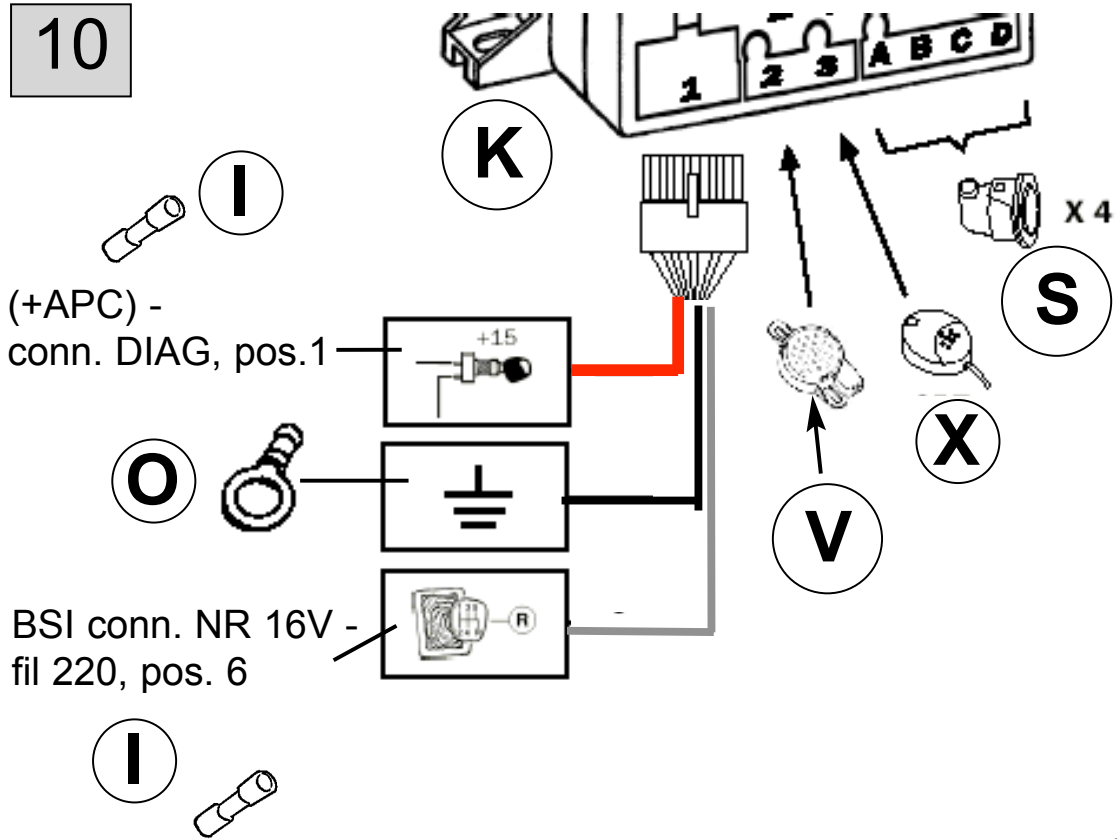

11

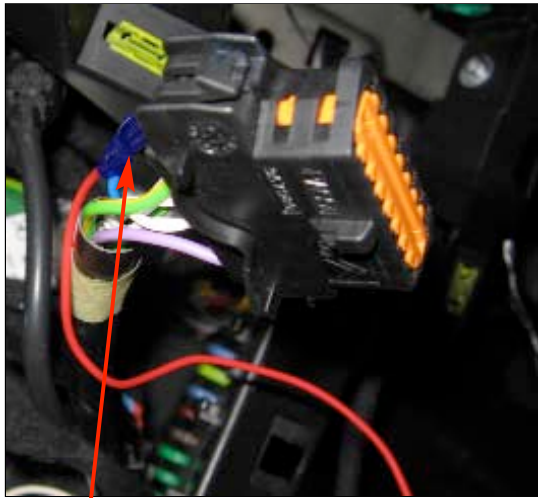

(+APC) - conn. DIAG, pos.1

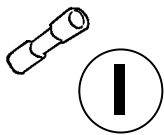

(MAR) - BSI, conn. NR 16V, pos.6

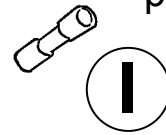

12



masse

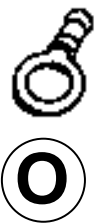

13

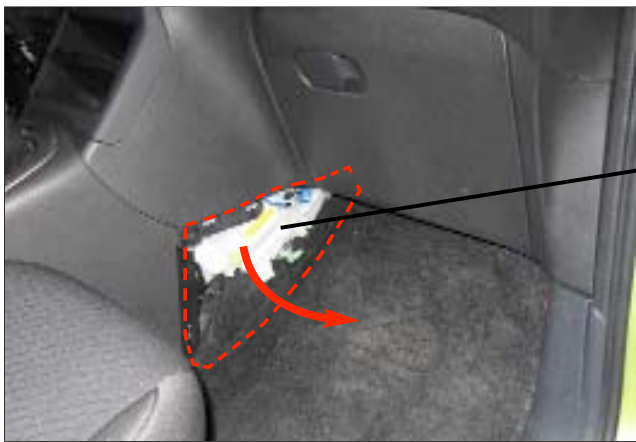

14

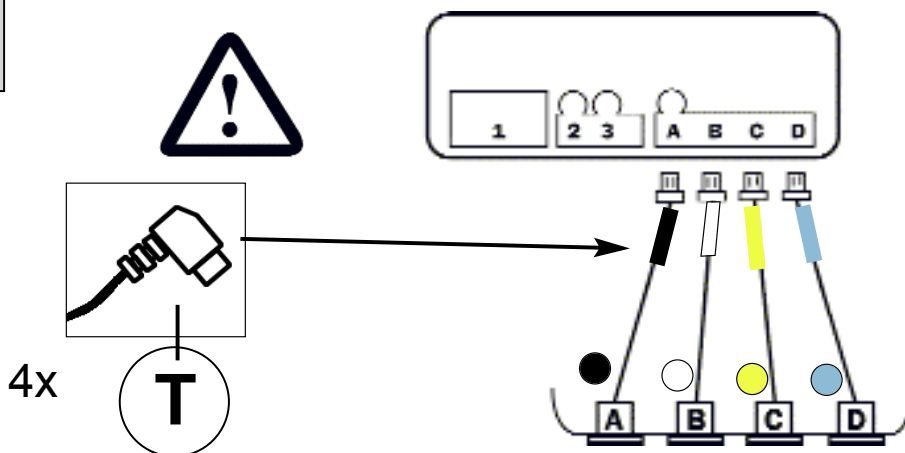

15

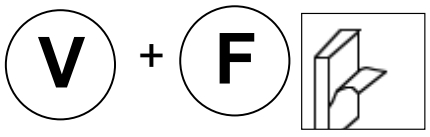
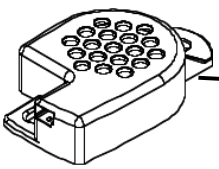
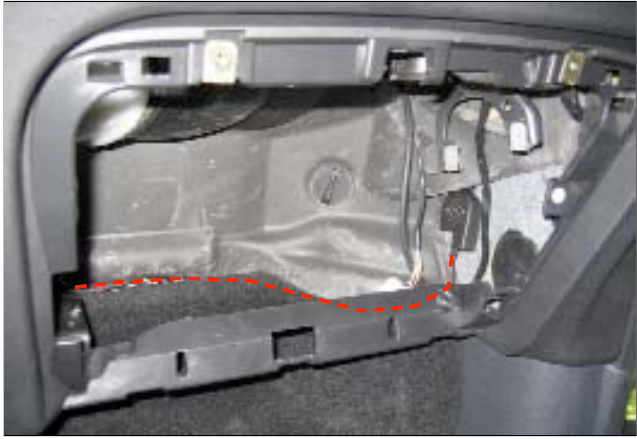

16

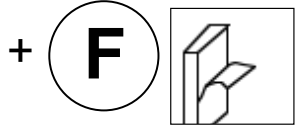
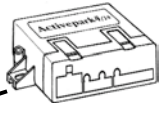

17

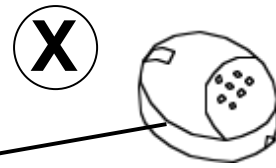

18

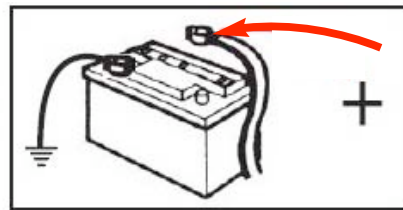

19

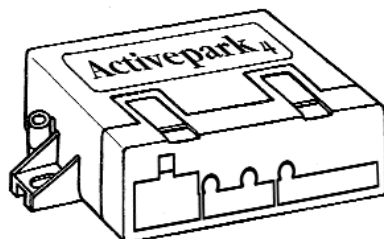

 OFFSET  VOL.  SENS.

20

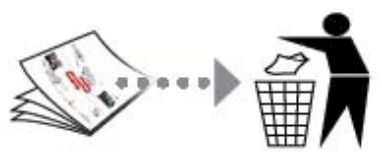
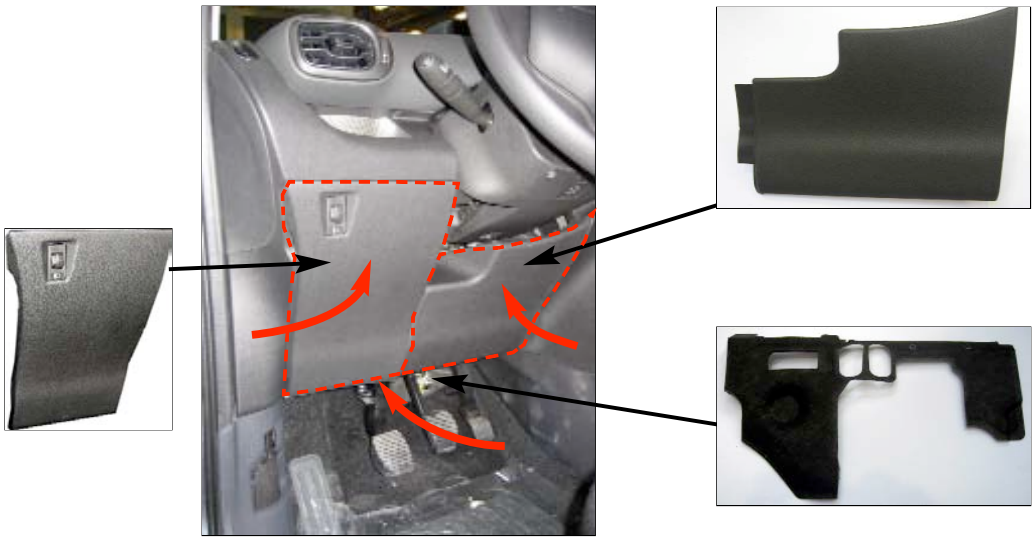

C3 (A51)



2,15h

1

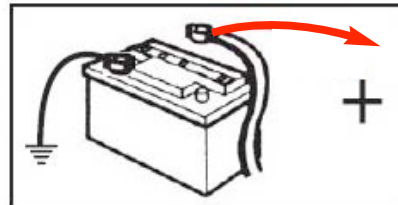

2

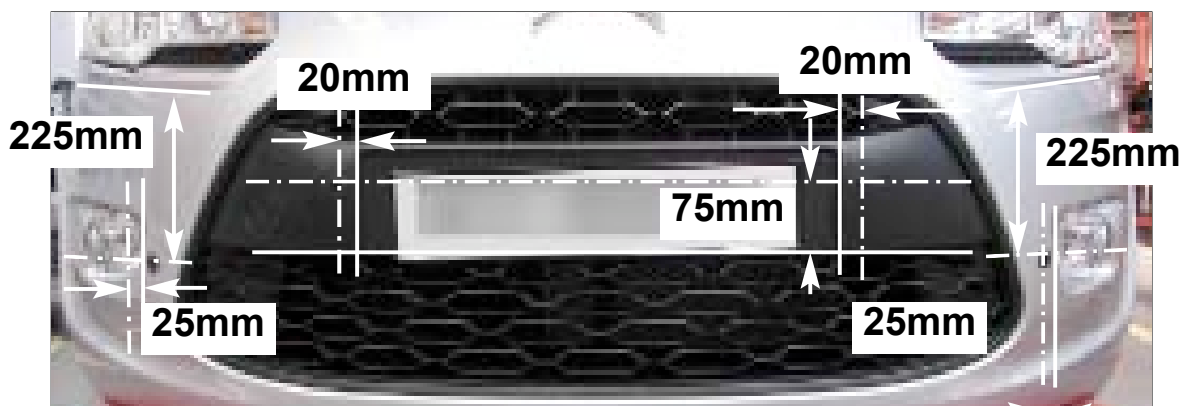

3

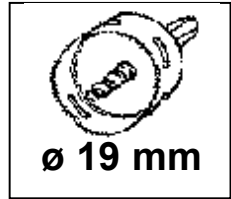
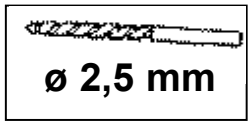
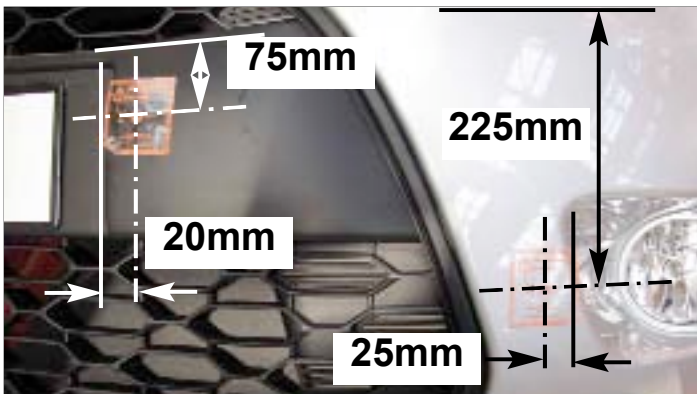
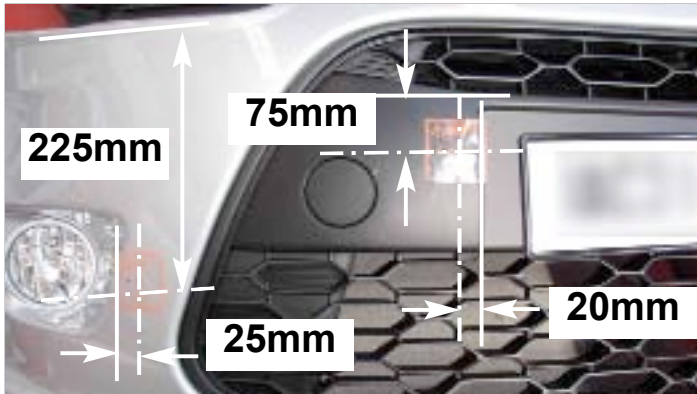

L

4x

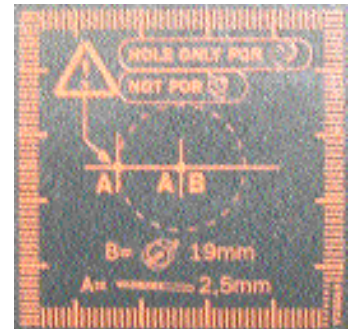

4

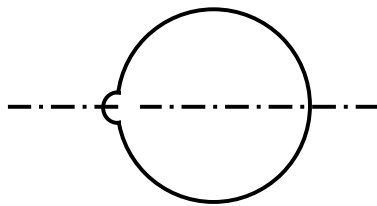

5

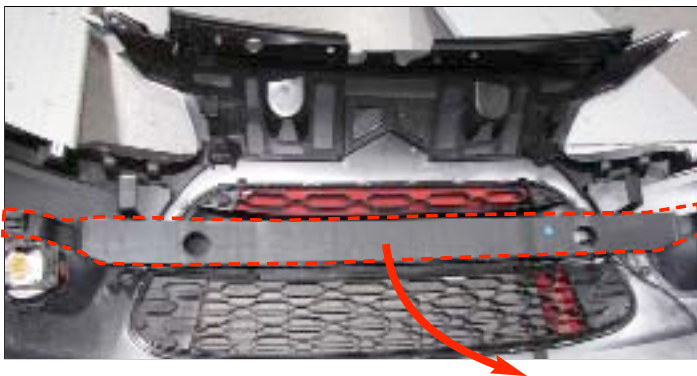

6

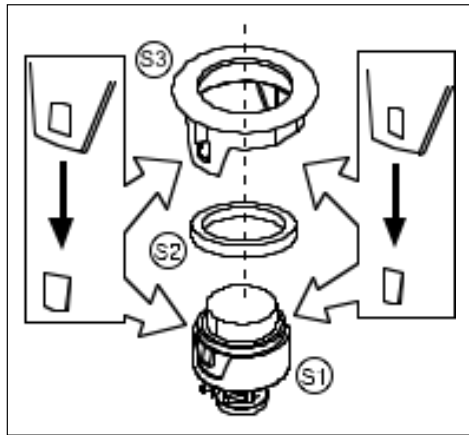

4x

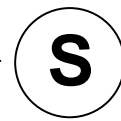

7

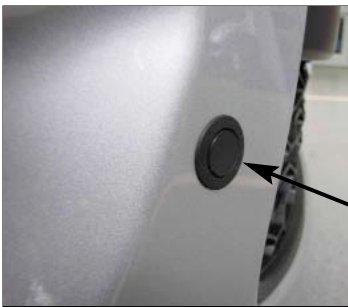
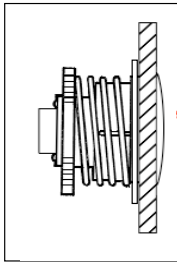

8



9

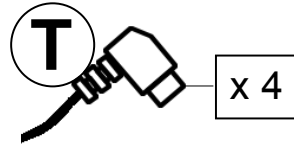
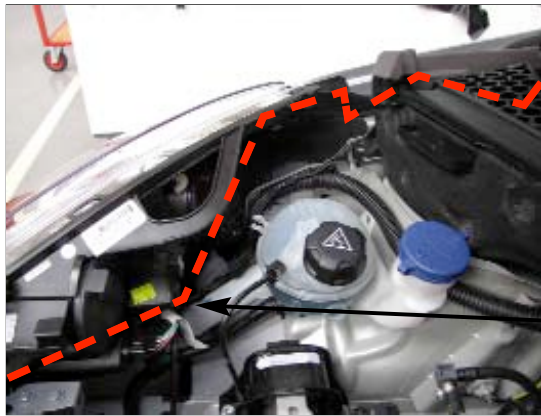
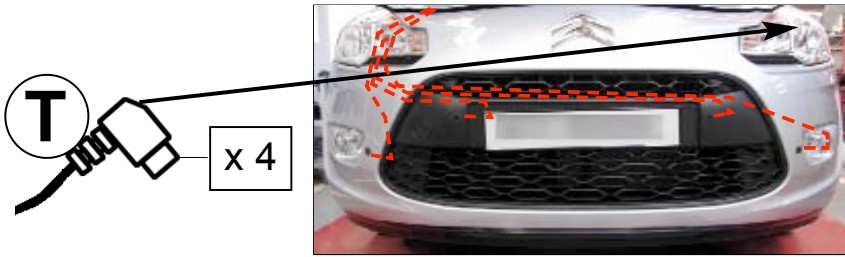

10

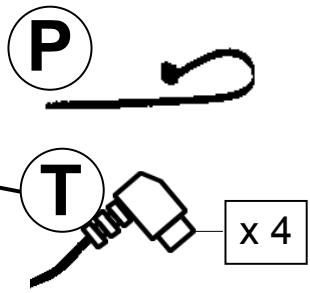

11

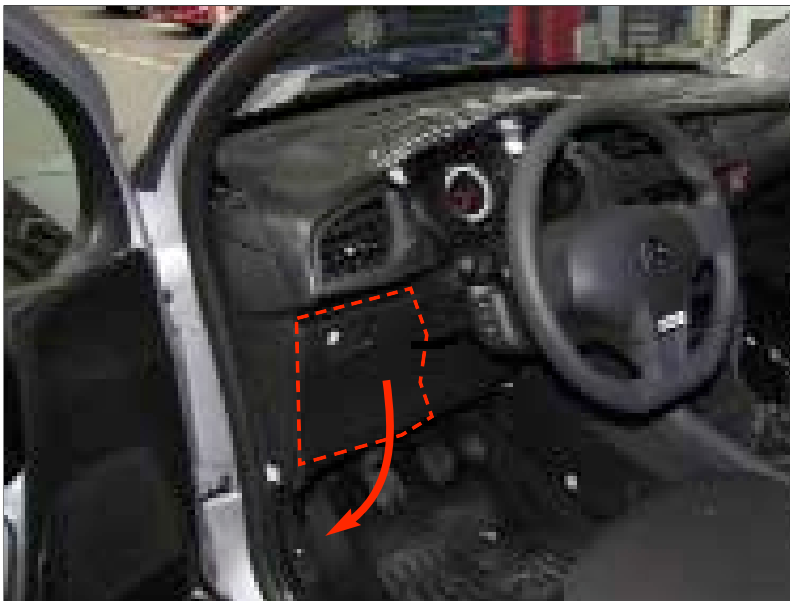

12

(+APC) -
conn. GR 16V, pos. 1

conn. NR 16V,
pos. 6

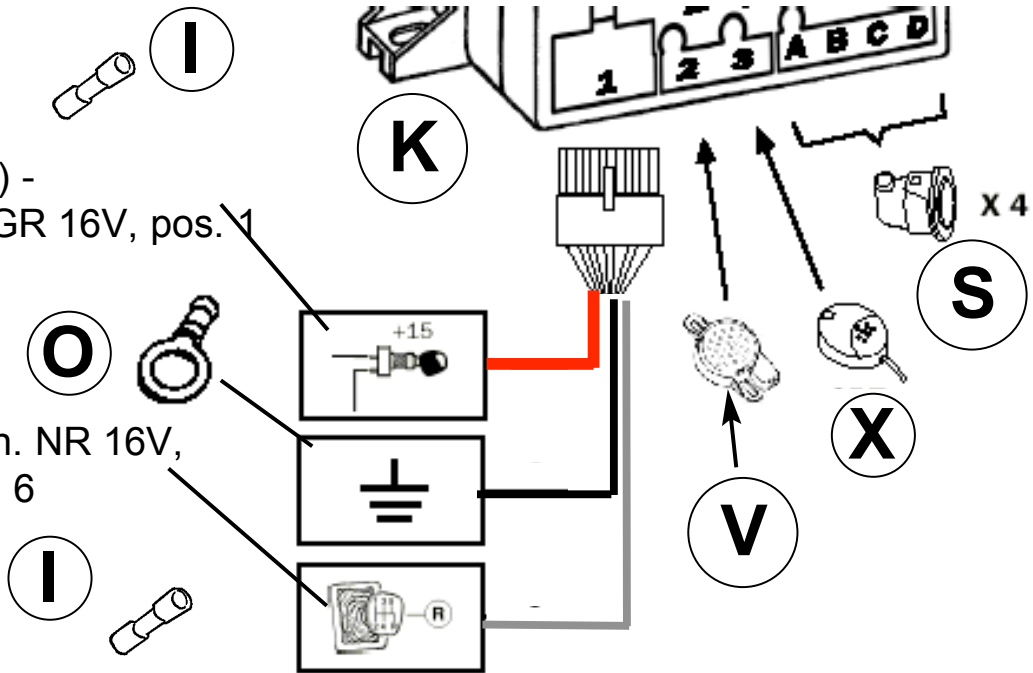

13



(+APC) - conn. GR 16V, pos. 1



- conn. NR 16V, pos. 6

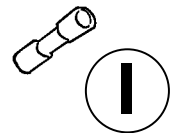
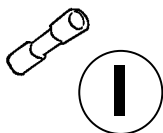

14



15



16

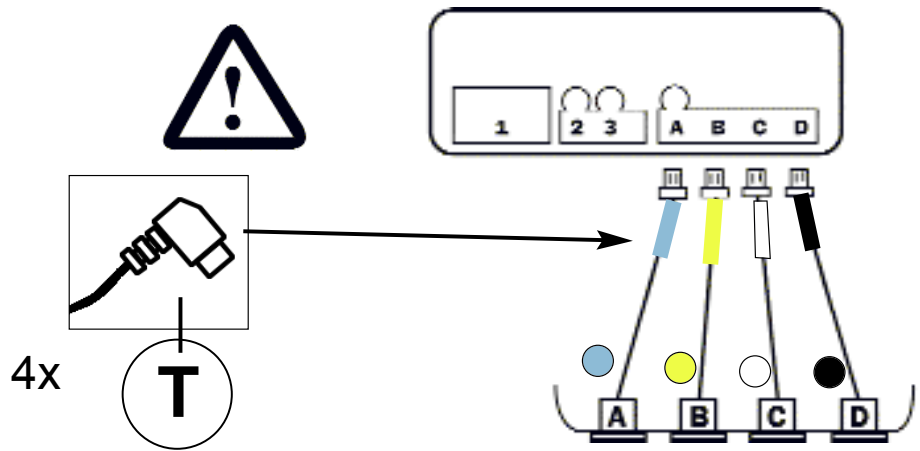

17

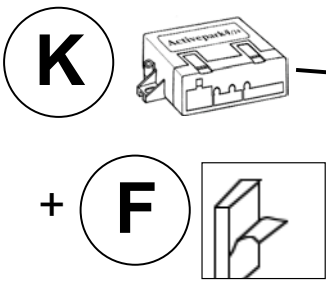
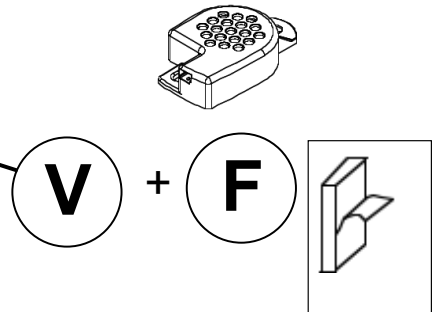
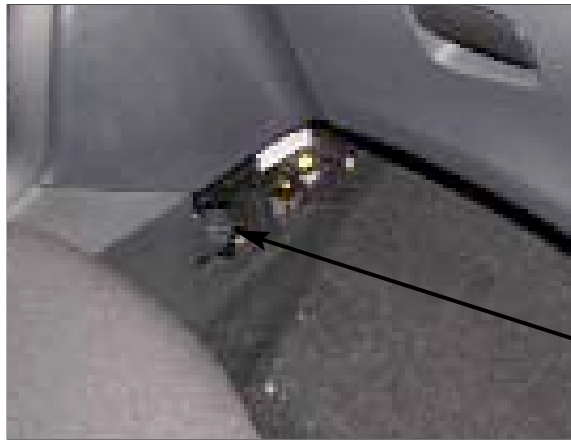

18

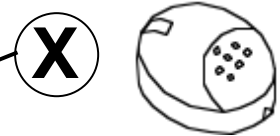

19

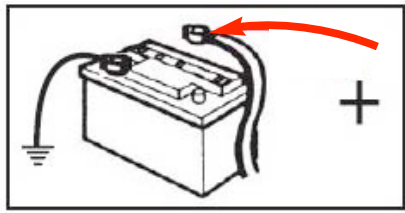

20

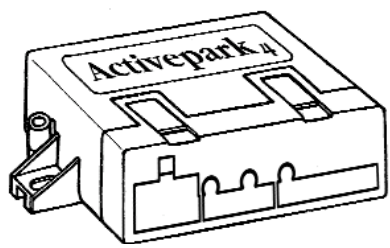

21

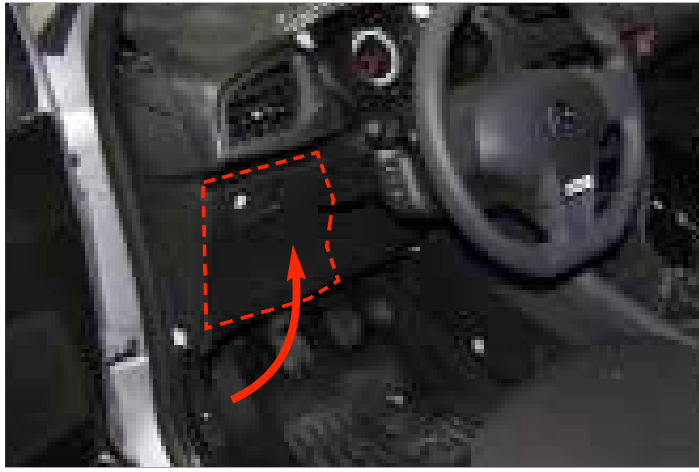

C4 Berline & Coupé (B5A) I-> O 11558



2,15h

1

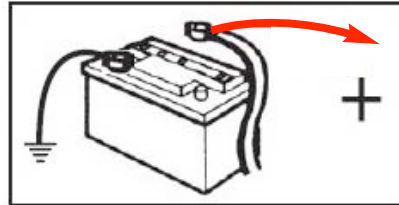

2

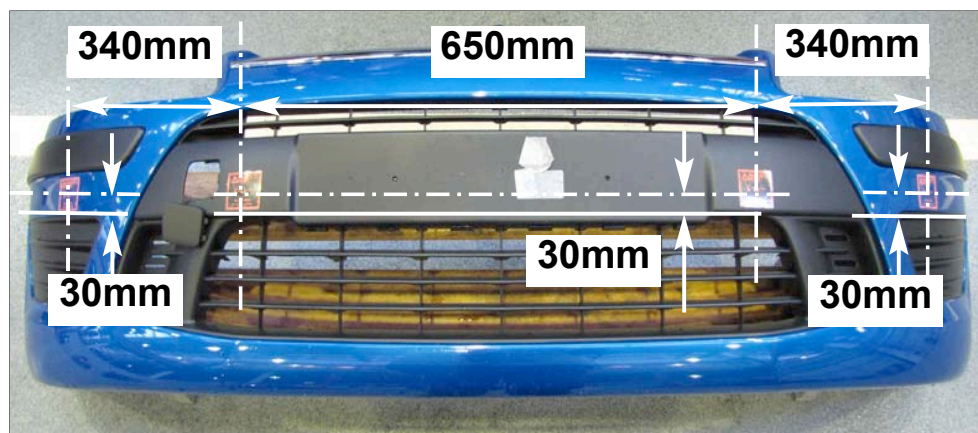
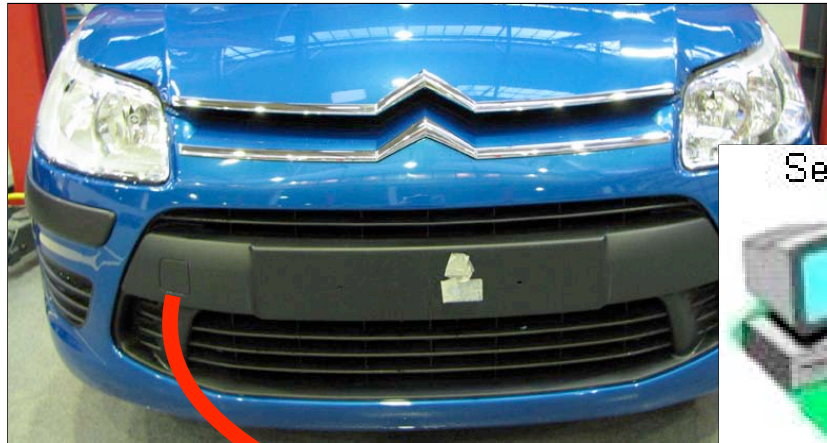

3

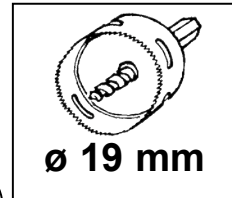
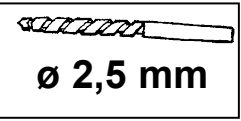
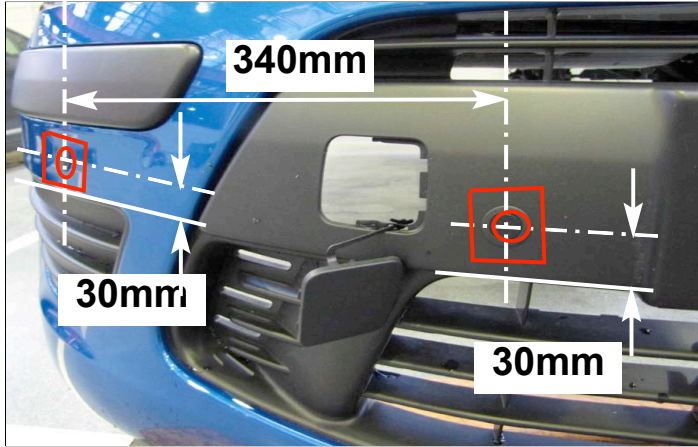

L

4x

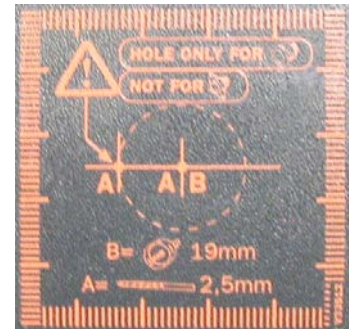
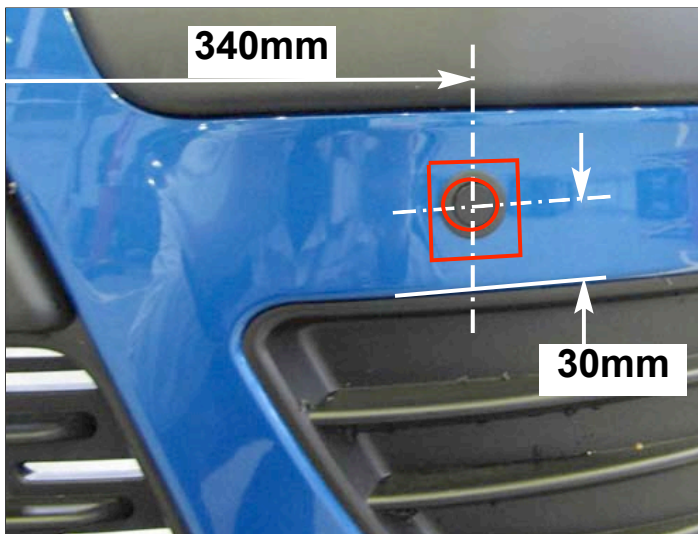

4

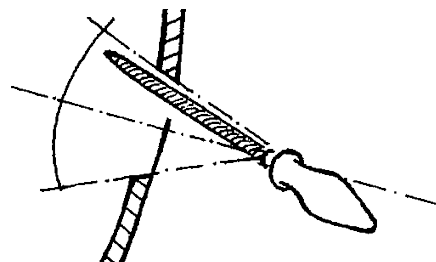
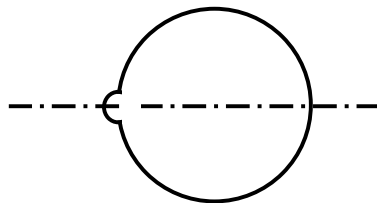

5

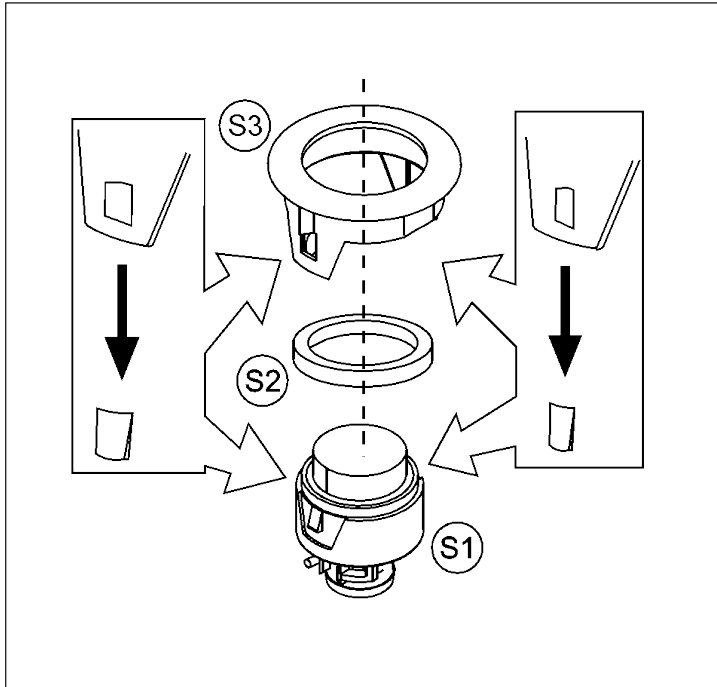

4x



6

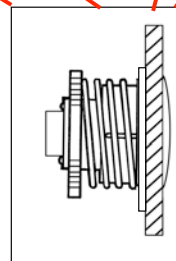
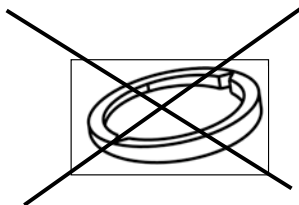
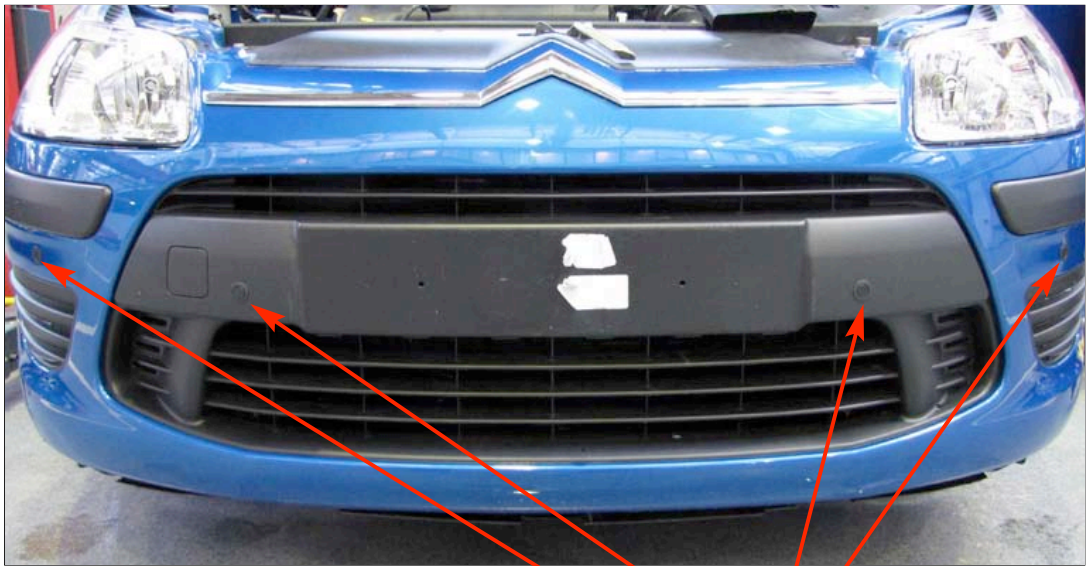

7

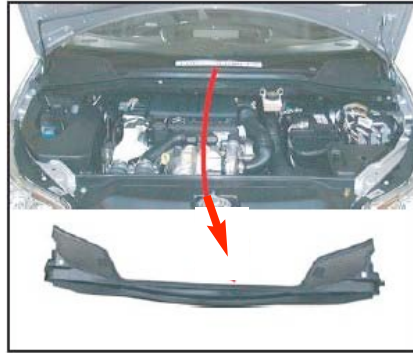
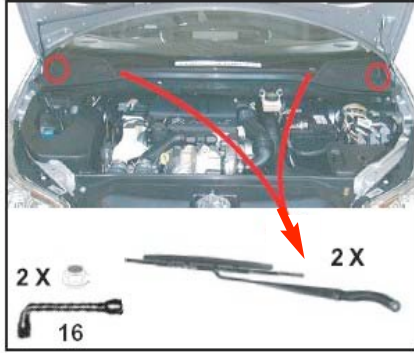

8

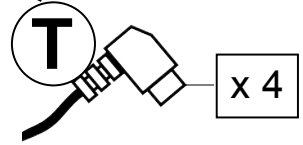
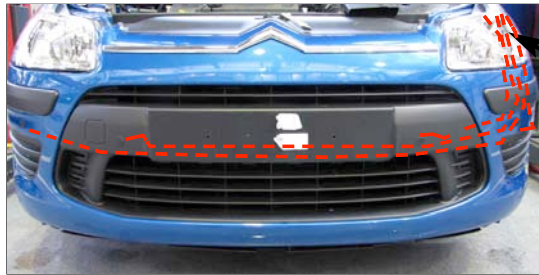

9

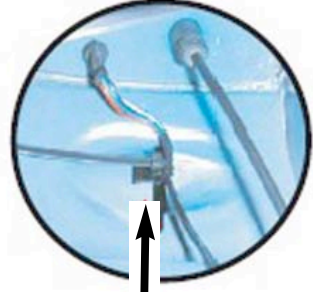
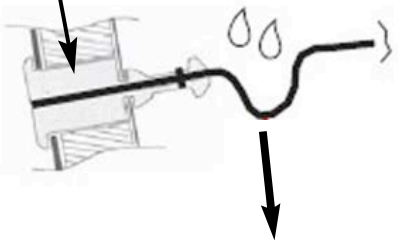
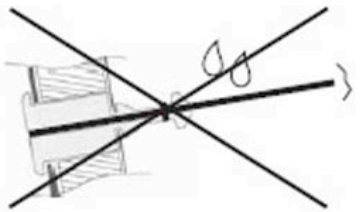
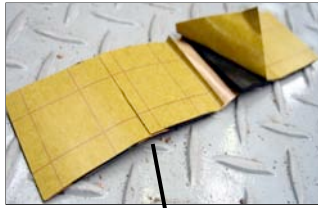

P1

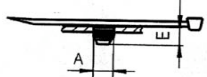

10

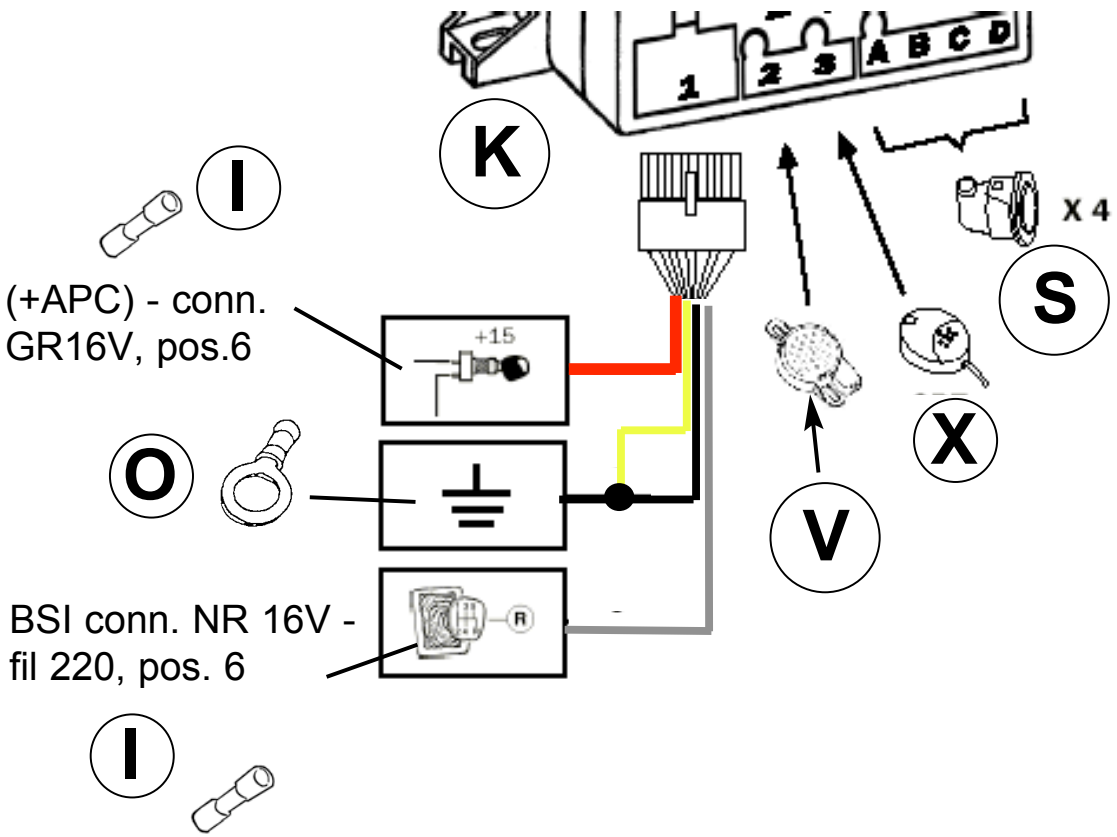

11

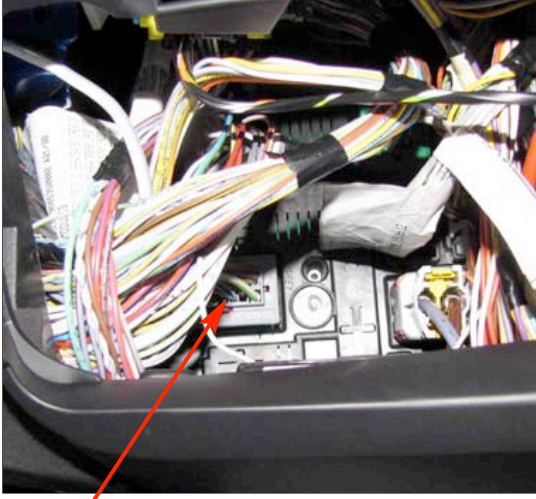

(+APC) - conn. GR16V, pos.6

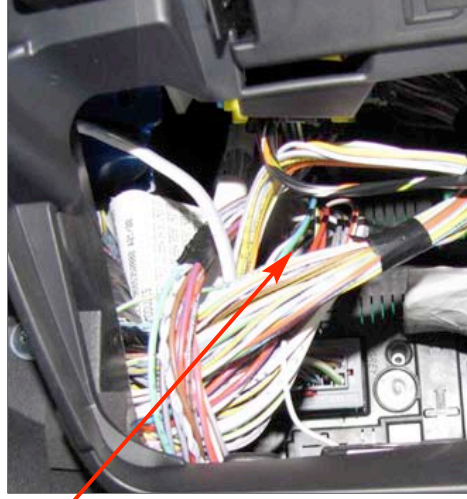
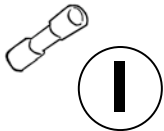

- BSI, conn. NR 16V, pos.6

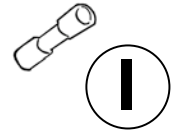

12

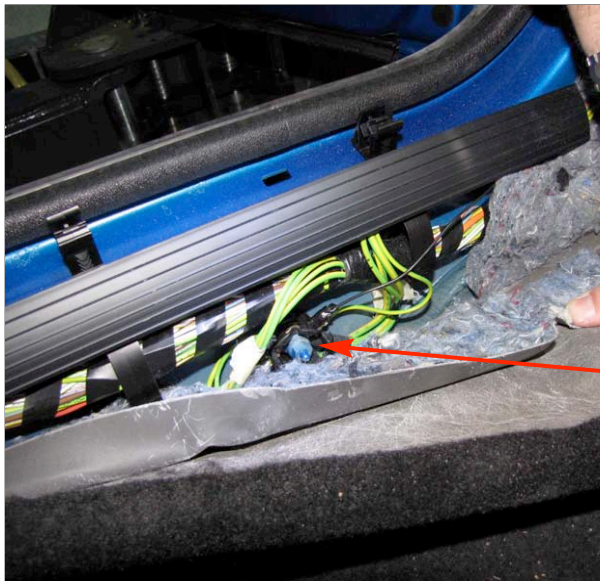

13

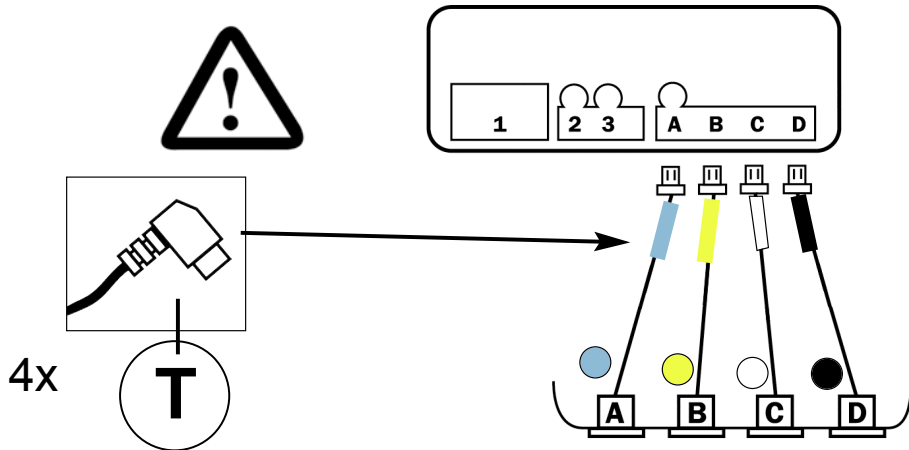

14

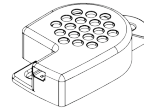

V

+

F

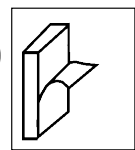

K

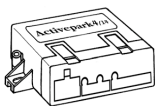

+

F

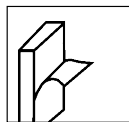

15

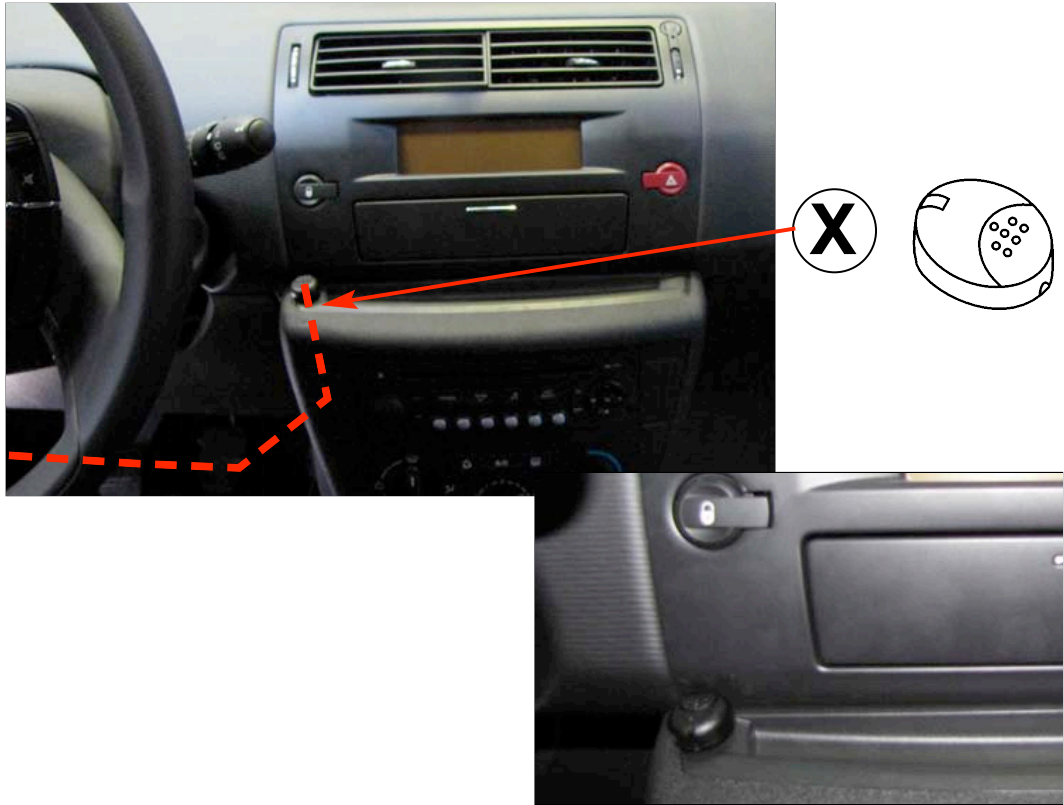

16

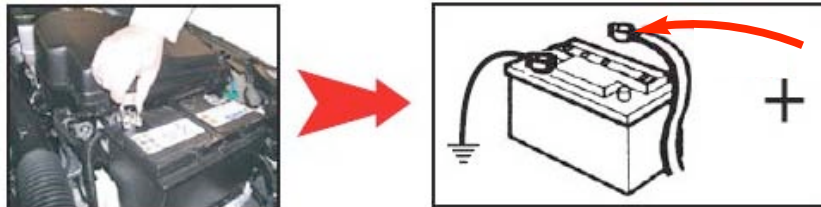

17

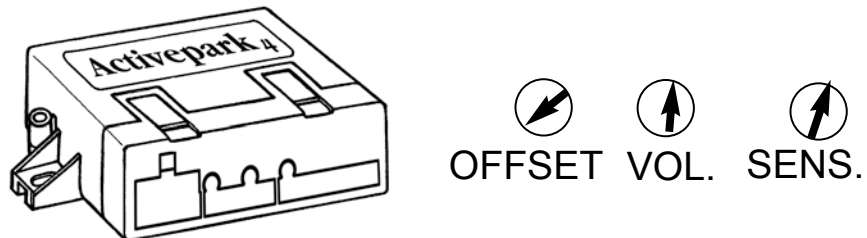

18

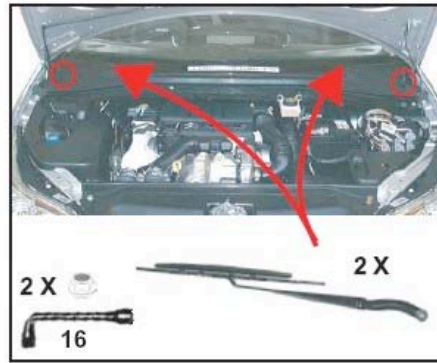
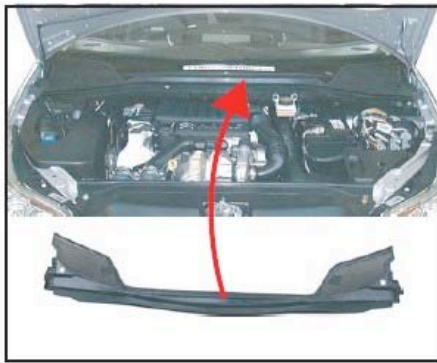

19



C4 Picasso (B585)



2,30h

1

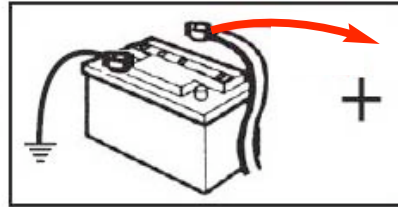

2



3

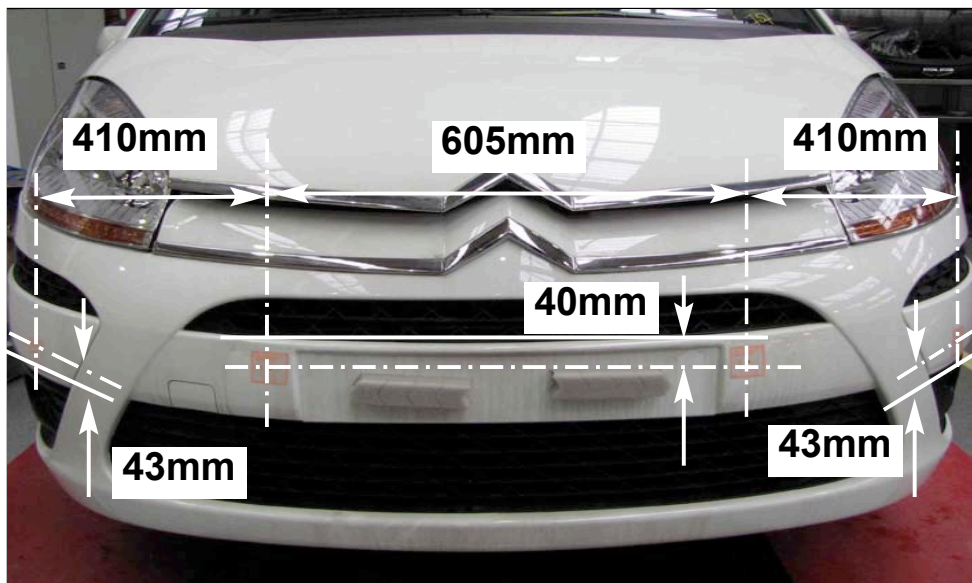

4

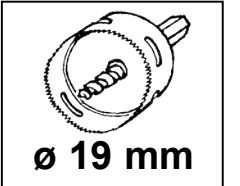
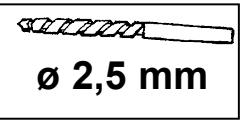
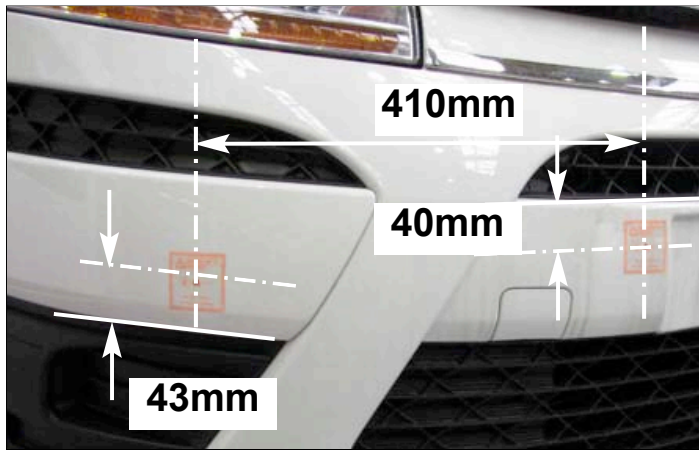

4x

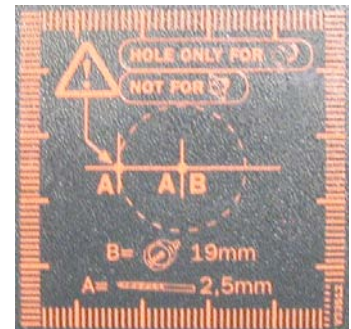
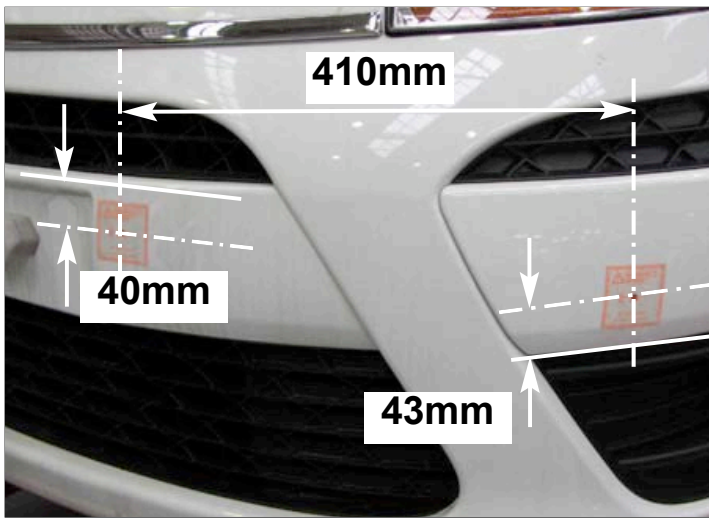

5

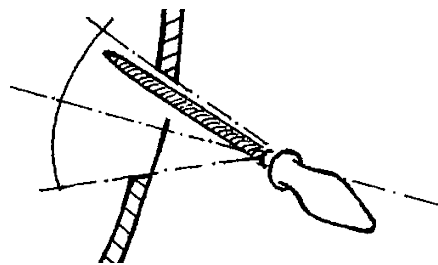
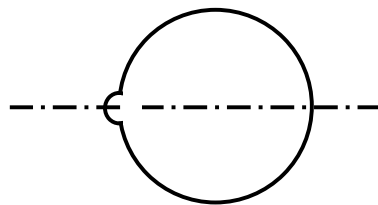

6

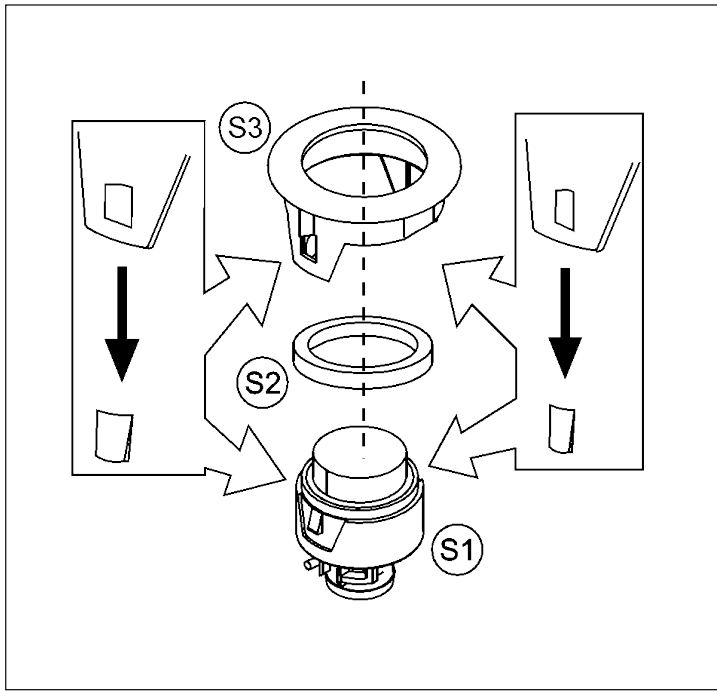

4x

S

7

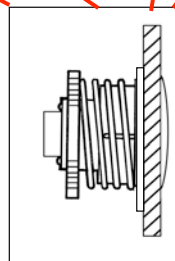
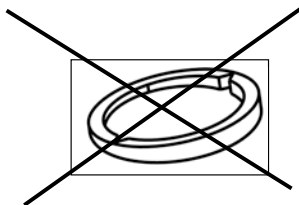
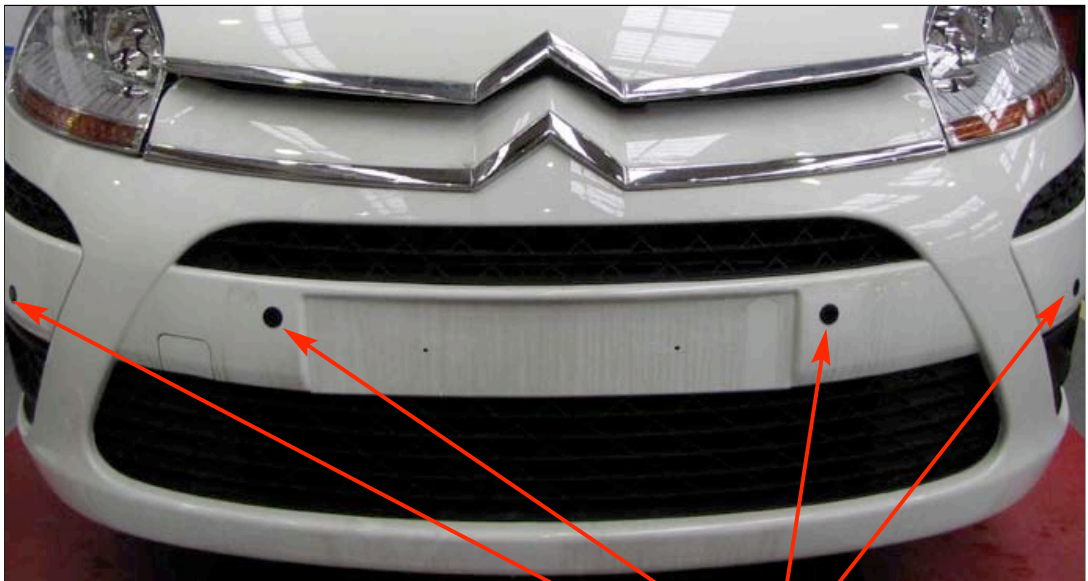

8



9

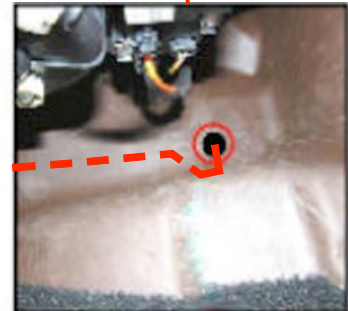
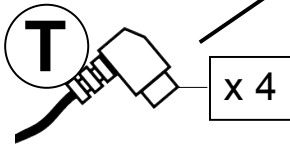
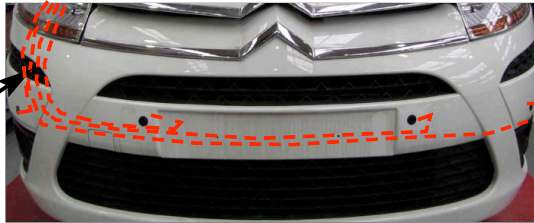

11

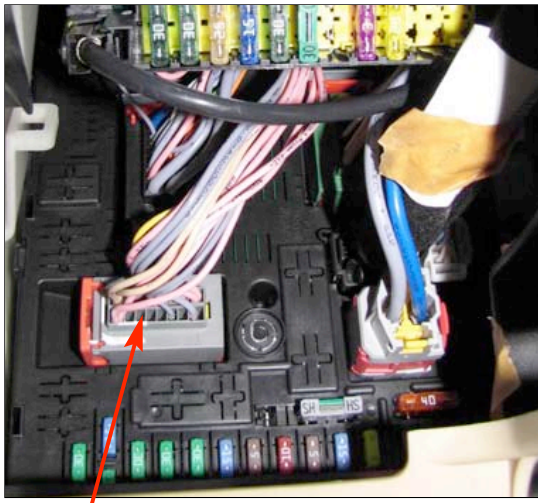

(+APC) - conn. GR16V, pos.6

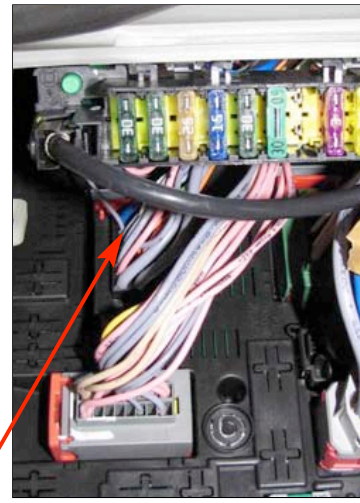
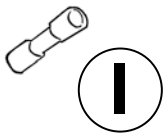

- BSI, conn. NR 16V, pos.6

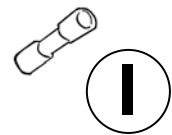

12



13

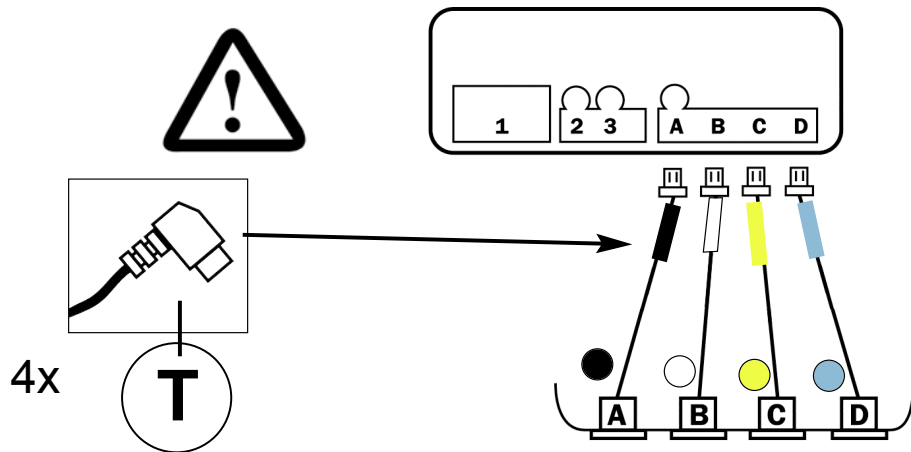

14

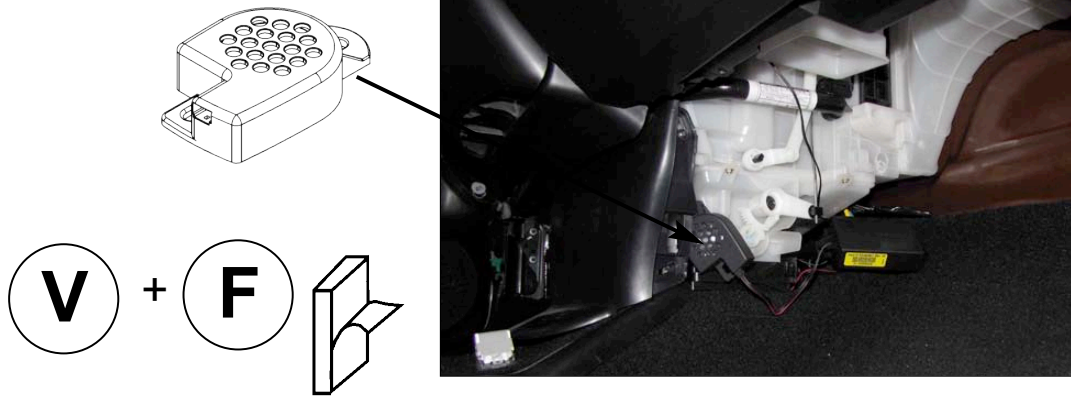

15



16

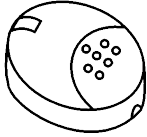
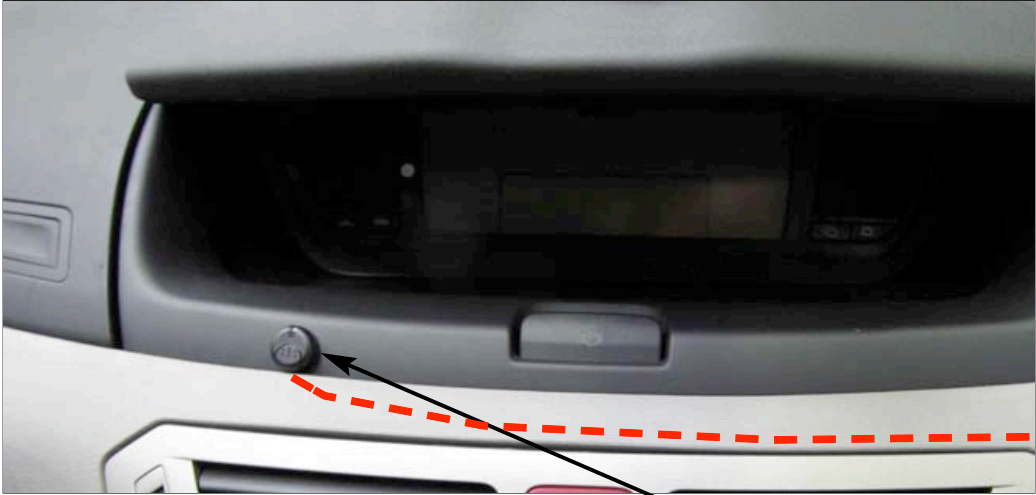

17

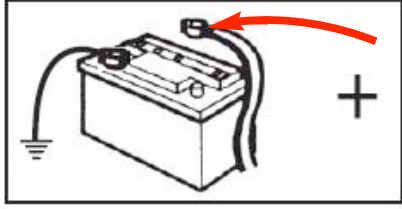

18



OFFSET



VOL.



SENS.

19

