

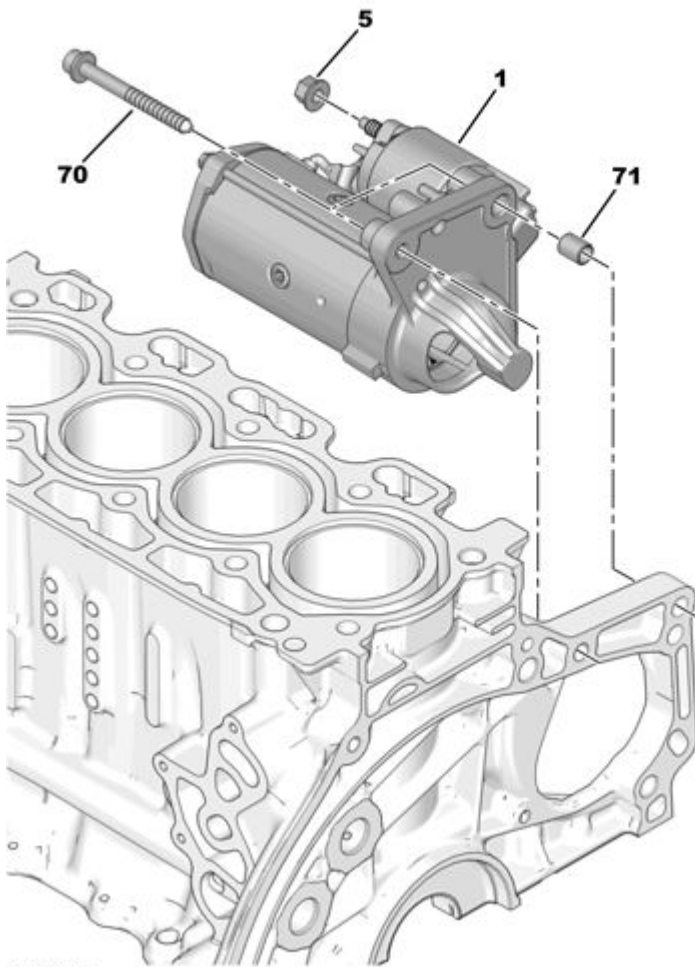





09.10.23 533045A  
КРЕПЛЕНИЕ СТАРТЕРА



03/2013

00097861

01	5802 AE	REACH	01	СТАРТЕР НОВЫЙ CLASSE 6 VALEO (DEMARR) - D 7 G 26	      
	16 381 168 80	REACH	01	CLASSE 6 VALEO (DEMARR) - TS 22 E 26  E:СТАРТЕР ВЗЧ PSA <i>- И СРОК ЭКСПЛУАТАЦИИ &gt;= 3</i>	
	5802 CE	REACH	01	СТАРТЕР ВЗЧ CLASSE 6 VALEO (DEMARR) - TS 22 E 26 01 CLASSE 6 VALEO (DEMARR) - D 7 G 26	
05	4503 43	REACH	01	(MUL) ГАЙКА С БУРТИКОМ M8X125-8-13	
70	6913 E8	REACH	02	(MUL) БОЛТ СНС RDL DIAM 8X125-80	
71	6968 42	REACH	01	(MUL) ШПЛИНТ 12X15	