

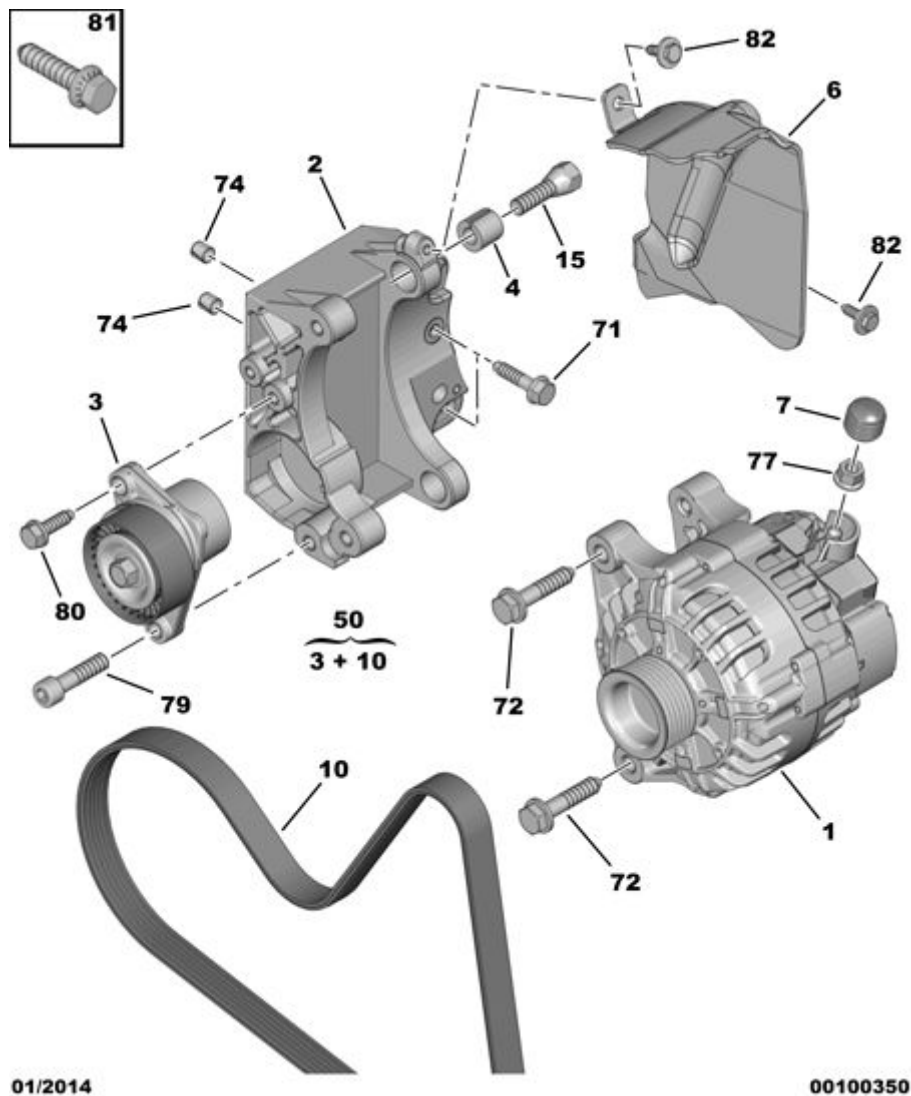









## 28.08.18 532015A ГЕНЕРАТОР И КРЕПЛЕНИЯ

- А) ДЛЯ ГЕНЕРАТОРА ПЕРЕМЕННОГО ТОКА НА 80 АМПЕР +  
В) ДЛЯ ГЕНЕРАТОРА ПЕРЕМЕННОГО ТОКА НА 120 АМПЕР



01	5705 6N RP 98 018 953 80	REACH	01 НОВЫЙ ГЕНЕРАТОР 01 120 AMP 01 VALEO(ALTERNAT) - SG12S077 01 120 AMP 01 VALEO(ALTERNAT) - SG12S051  01 120 AMP 01 MITSUBISHI* - A 003 TB 2691  01 120 AMP 01 VALEO(ALTERNAT) - SG12S  E:ГЕНЕРАТОР ВЗЧ PSA 01 - И СРОК ЭКСПЛУАТАЦИИ >= 3  ГЕНЕРАТОР ВЗЧ 01 120 AMP 01 VALEO(ALTERNAT) - SG12S 01 120 AMP 01 VALEO(ALTERNAT) - SG 12 S 077  01 120 AMP 01 VALEO(ALTERNAT) - SG 12 S 051  01 120 AMP 01 MITSUBISHI* - A 003 TB 2691	        
02	5706 F8 RP 5706 L8 + 16 369 960 80	REACH	01 ОПОРА ГЕНЕРАТОРА 01 01	
03	5751 C3 RP 16 369 960 80	REACH	01 РОЛИК НАТЯЖНОЙ ГЕНЕРАТОРА 01	
04	5703 84	REACH	02 КОЛЬЦО ПОДШИПН. ГЕНЕРАТОРА	
06	5733 A3	REACH	01 ЗАЩИТА ГЕНЕРАТОРА	
07	5733 75	REACH	01 ЗАЩИТА ГЕНЕРАТОРА DIAM EXT 22	
10	5750 WZ 16 063 506 80	REACH	01 РЕМЕНЬ ПРИВОДА ГЕНЕРАТОРА K6 LE 1069  E:ТРАПЕЦИЕВИДНЫЙ РЕМЕНЬ AM 01 POLY V - И СРОК ЭКСПЛУАТАЦИИ >= 3	
15	5703 98	REACH	02 (MUL) БОЛТ ОСИ 10X150-28	
71	6925 J5 RP 6925 W5	REACH	04 (MUL) БОЛТ С ОПОРНОЙ ШАЙБОЙ DIAM 8X125-60 01	
72	6923 E9	REACH	02 (MUL) БОЛТ TH RDL 10X150-50	
74	6968 51	REACH	02 (MUL) ШПЛИНТ DIAM E8 L12	
77	6936 51	REACH	01 (MUL) ГАЙКА С БУРТИКОМ 8X125-8-13	
79	6913 99 RP 6913 R8	REACH	01 (MUL)ВИНТ-САМОР ГОЛ ПОД ШЕСТИГ DIAM 10X150-40 01	
80			01 (MUL) БОЛТ С ОПОРНОЙ ШАЙБОЙ	

	6925 99	REACH	03	DIAM 8X125-45
81	6922 75	REACH	01	(MUL) БОЛТ ТН RDL DIAM 6X100-50
82	6923 95	REACH	02	(MUL) БОЛТ ТН RDL DIAM 6X100-20