

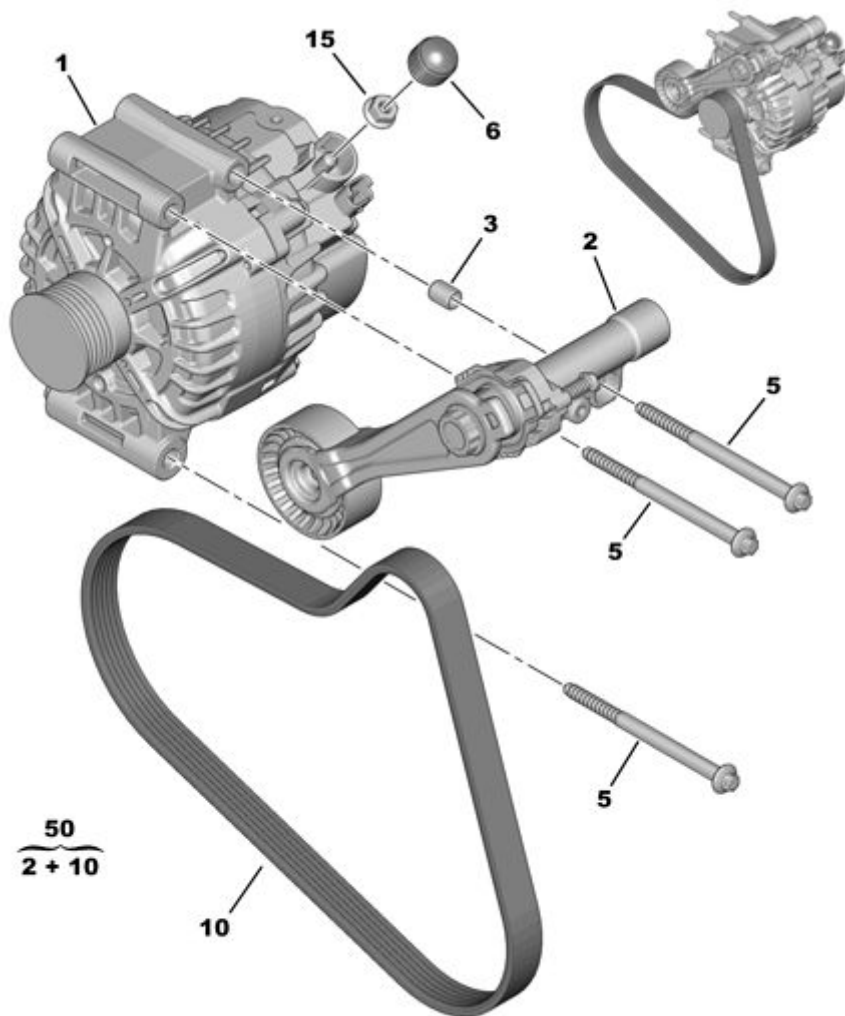







21.12.18 532010C ГЕНЕРАТОР И КРЕПЛЕНИЯ



12/2013

00100270

01	5705 NR	REACH	01	НОВЫЙ ГЕНЕРАТОР 150 AMP K6 VALEO(ALTERNAT) - FG15T072	
			01	150 AMP K6 VALEO(ALTERNAT) - FG15T044	
			01	150 AMP K6 BOSCH - 0121615027	
			01	150 AMP K6 BOSCH - 0121615012	
	5702 L3	REACH	01	ГЕНЕРАТОР ВЗЧ 150 AMP K6 BOSCH - 0121615027	 
			01	150 AMP K6 BOSCH - 0121615012	
			01	150 AMP K6 VALEO(ALTERNAT) - FG15T072	
			01	150 AMP K6 VALEO(ALTERNAT) - FG15T044	
02	5751 G9 RP 16 114 254 80	REACH	01 01	РОЛИК НАТЯЖНОЙ ДИНАМИЧЕСКИЙ	
03	2104 10	REACH	01	(MUL) ШПЛИНТ 9,2 X 11,027 - 14	
05	5703 A6	REACH	03	БОЛТ КРЕПЛЕН. ГЕНЕРАТОРА DIAM 8X125 LG 114	
06	5733 75	REACH	01	ЗАЩИТА ГЕНЕРАТОРА DIAM EXT 22	
10	5750 RG	REACH	01	РЕМЕНЬ ПРИВОДА ГЕНЕРАТОРА K6 LE 905	
	16 063 495 80	REACH	01	Е:ТРАПЕЦИЕВИДНЫЙ РЕМЕНЬ PSA POLY V <i>- И СРОК ЭКСПЛУАТАЦИИ >= 3</i>	
15	4503 43	REACH	01	(MUL) ГАЙКА С БУРТИКОМ M8X125-8-13	
50	16 112 791 80	REACH	01	КОМПЛ. ПРИВОДА ОБОРУДОВАНИЯ	
	16 134 450 80	REACH	01	Е:КОМПЛЕКТ ПРИВОДА ОБОРУД. PSA <i>- И СРОК ЭКСПЛУАТАЦИИ >= 3</i>	