

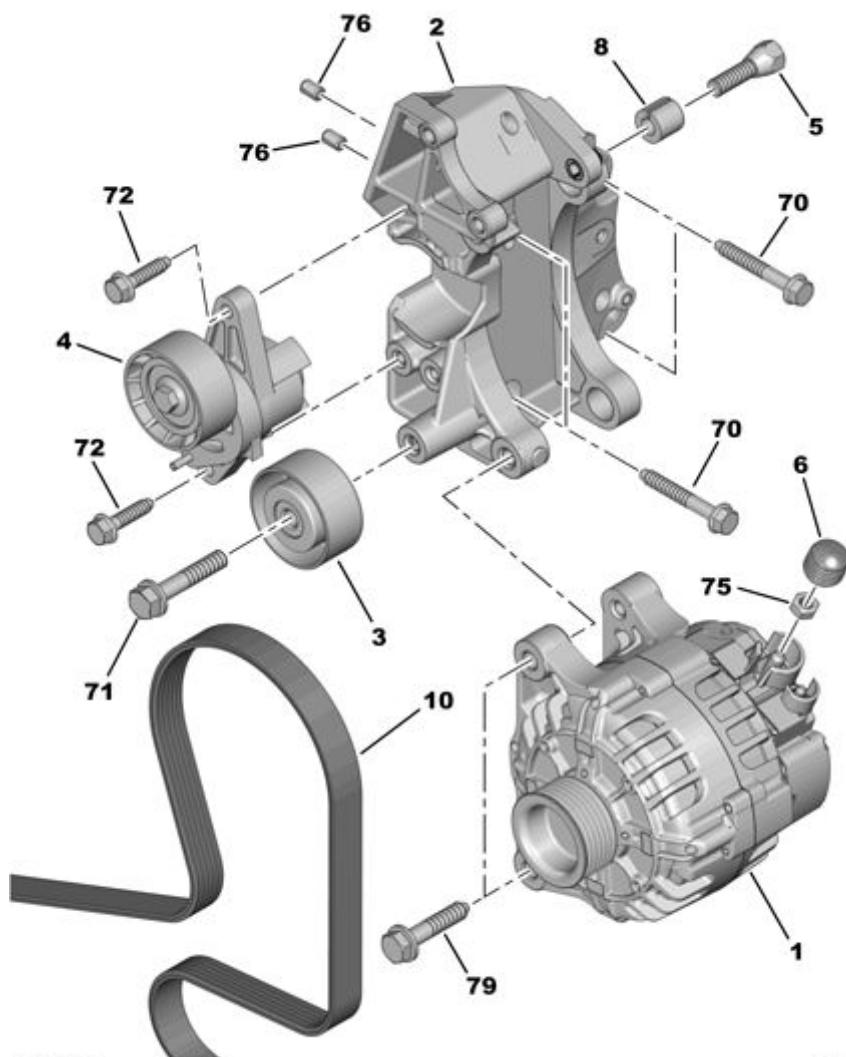





05.09.18 532017L

ГЕНЕРАТОР И КРЕПЛЕНИЯ



10/2013

00052415

01	5705 AZ	REACH RP 5705 KY	ГЕНЕРАТОР НОВЫЙ 01 CL8+ 01 MAGNETI MARELLI - 63 3217-34 01 CL8+ 01 VALEO(ALTERNAT) - SG9B063 01 CL8+ 01 VALEO(ALTERNAT) - SG8B021 01 CL8+ 01 DENSO MANUFACTU - MS1022118440 01 CL8+ 01 DENSO MANUFACTU - MS1022118400 01 CL8+ 01 VALEO(ALTERNAT) - SG10B022 01 CL8+ 01 VALEO(ALTERNAT) - A13VI277+ 01 CL8+ 01 VALEO(ALTERNAT) - A13VI277 01 CL8+ 01 VALEO(ALTERNAT) - TG9B064 01 CL8+ 01 VALEO(ALTERNAT) - TG9B024 01 CL8+ 01 VALEO(ALTERNAT) - A13VI276 01 CL8+ 01 VALEO(ALTERNAT) - SG9B066 01 CL8+ 01 VALEO(ALTERNAT) - A13VI236 01 CL8+ 01 MITSUBISHI - A005TA6391	
	5705 FC	REACH	ГЕНЕРАТОР ВЗЧ 01 CL8+ DENSO MANUFACTU - MS1022118440 01 CL8+ DENSO MANUFACTU - MS1022118400 01 CL8+ VALEO(ALTERNAT) - TG9B024 01 CL8+ VALEO(ALTERNAT) - SG9B066	    
02	5706 J2	REACH	ОПОРА ГЕНЕРАТОРА 01	
03	5751 G3 RP 16 114 229 80	REACH	РОЛИК ОБВОДНОЙ ГЕНЕРАТОРА 01 DIAM 60 EP 26,4 01	
04	5751 C8 RP 16 114 245 80	REACH	РОЛИК НАТЯЖНОЙ ДИНАМИЧЕСКИЙ 01 01	
05	5703 98	REACH	(MUL) БОЛТ ОСИ 01 10X150-28	
06	5733 75	REACH	ЗАЩИТА ГЕНЕРАТОРА 01 DIAM EXT 22	

08	5703 84	REACH	02	КОЛЬЦО ПОДШИПН. ГЕНЕРАТОРА
10	5750 XA	REACH	01	РЕМЕНЬ ПРИВОДА ГЕНЕРАТОРА K6-LE 1564
70	6925 J5 RP 6925 W5	REACH	04 01	(MUL) БОЛТ С ОПОРНОЙ ШАЙБОЙ DIAM 8X125-60
71	6925 R9 RP 6922 G8	REACH	01 01	(MUL)УНИВЕРСАЛЬНЫЙ БОЛТ TH RDL DIAM 10X150-55
72	6925 61 RP 98 025 585 80	REACH	03 01	(MUL) БОЛТ С ОПОРНОЙ ШАЙБОЙ DIAM 8X125-35
75	6936 51	REACH	01	(MUL) ГАЙКА С БУРТИКОМ 8X125-8-13
76	6968 51	REACH	02	(MUL) ШПЛИНТ DIAM E8 L12
79	6923 E9	REACH	02	(MUL)УНИВЕРСАЛЬНЫЙ БОЛТ TH RDL 10X150-50