

автомобиль : XSARA		номер VIN: VF7N1RHYF36947082 / OPR : 8605	
область	омывание и очистка стекол	функция	стеклоочиститель ветрового стекла
составные части			

принцип

50

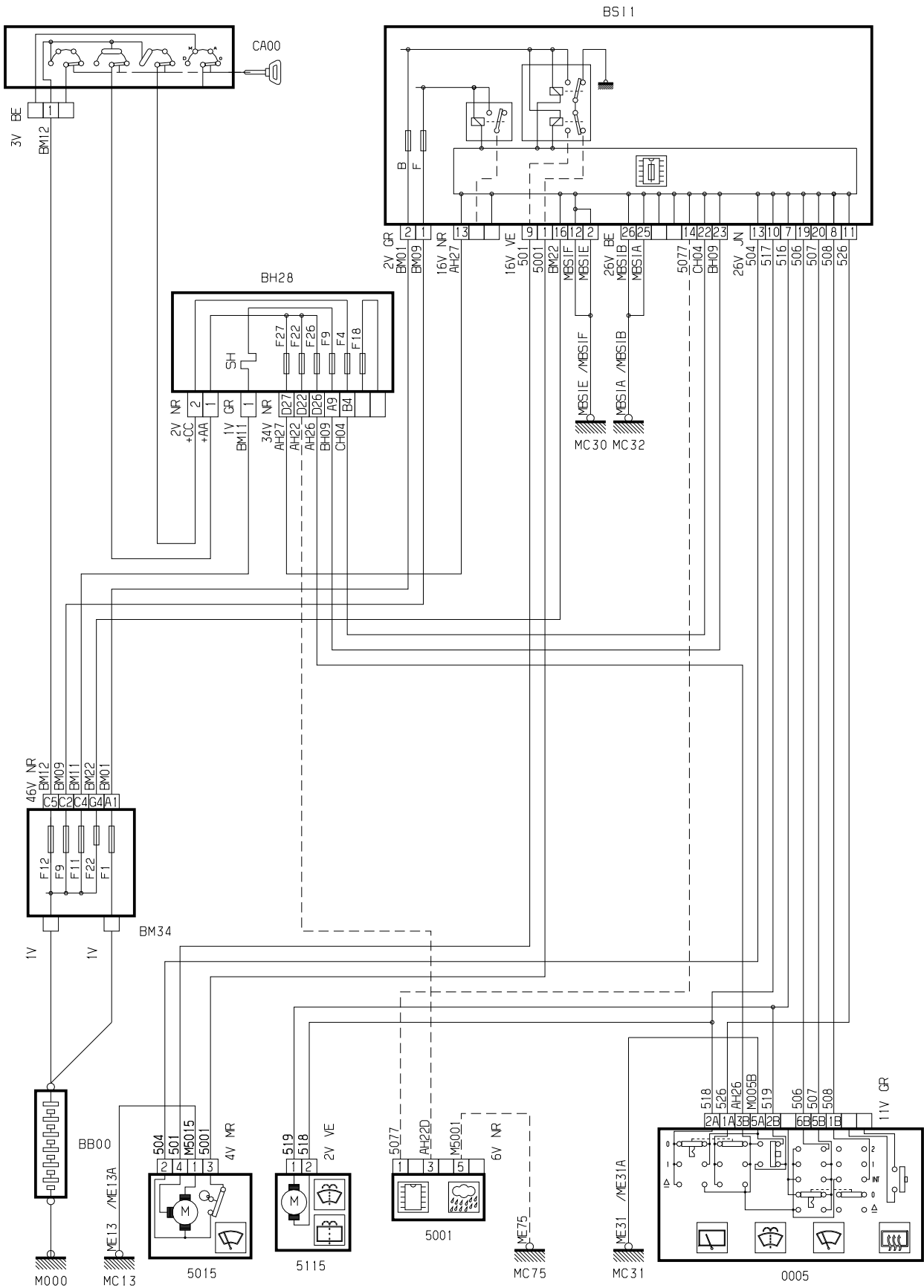

D3QA52AR

прокладка трубопроводов (кабелей, тросов)

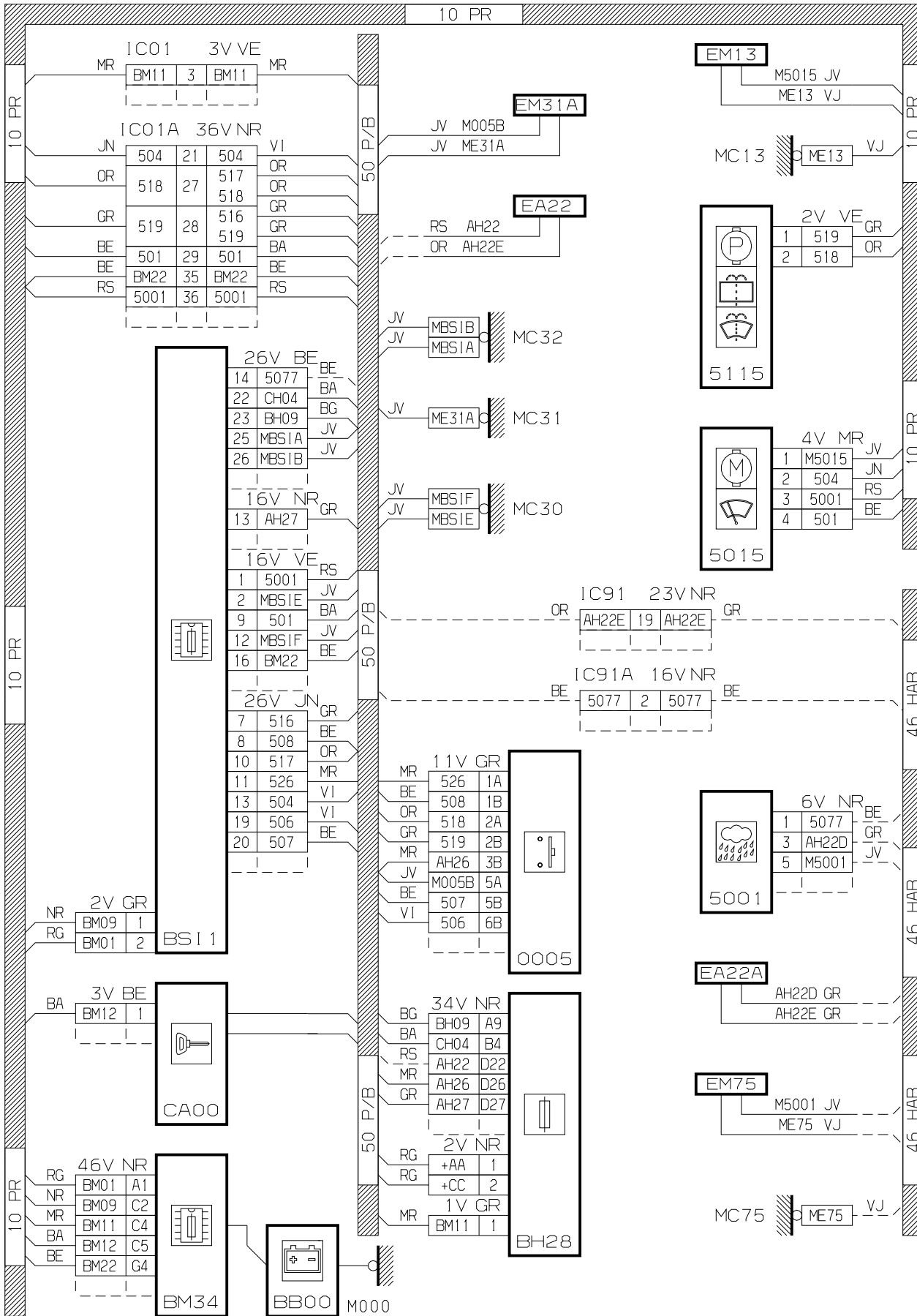

null

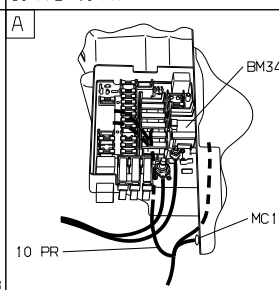
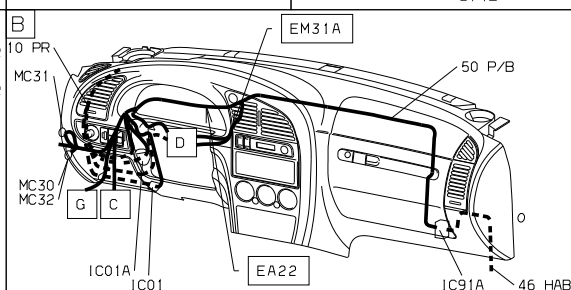
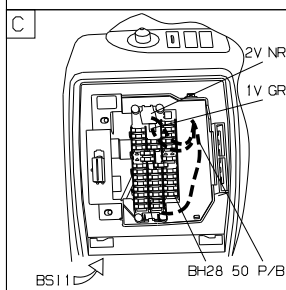
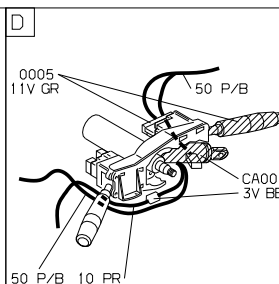
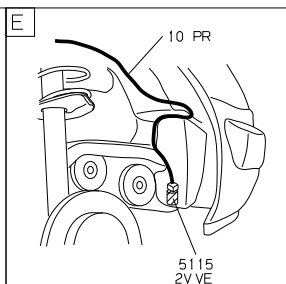
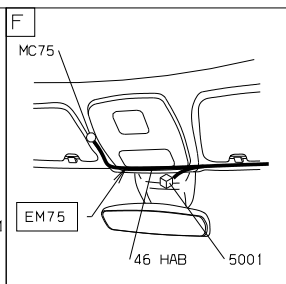
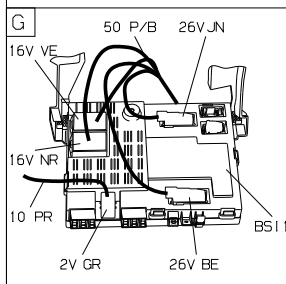
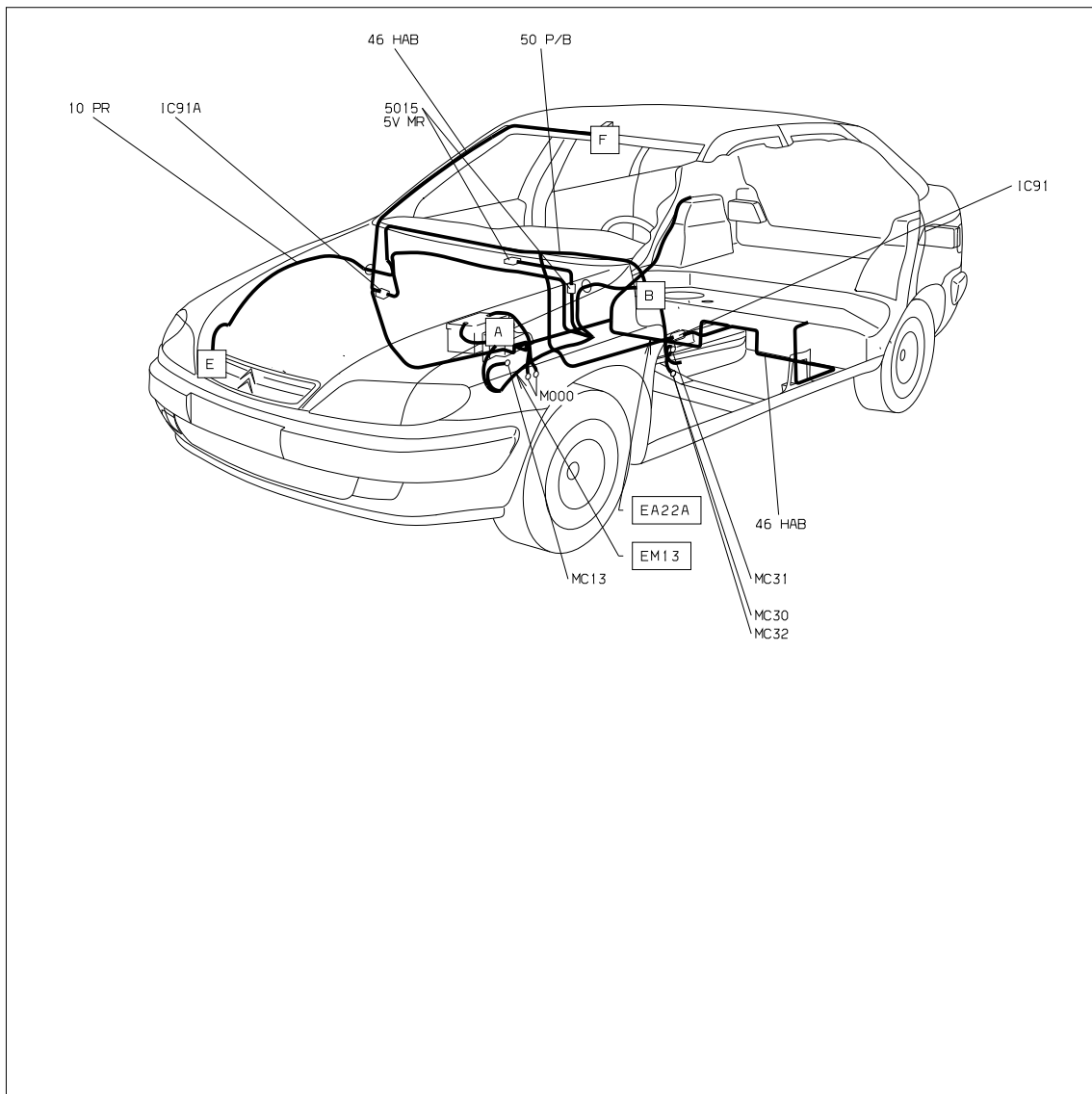

D3AQ52A1

собственность PSA Peugeot Citroen

04/12/2020